

# ASSEMBLY INSTRUCTIONS for Full Bed Conversion Kit UNIVERSAL 4 IN 1 CONVERTIBLE CRIB

## Model # 22288

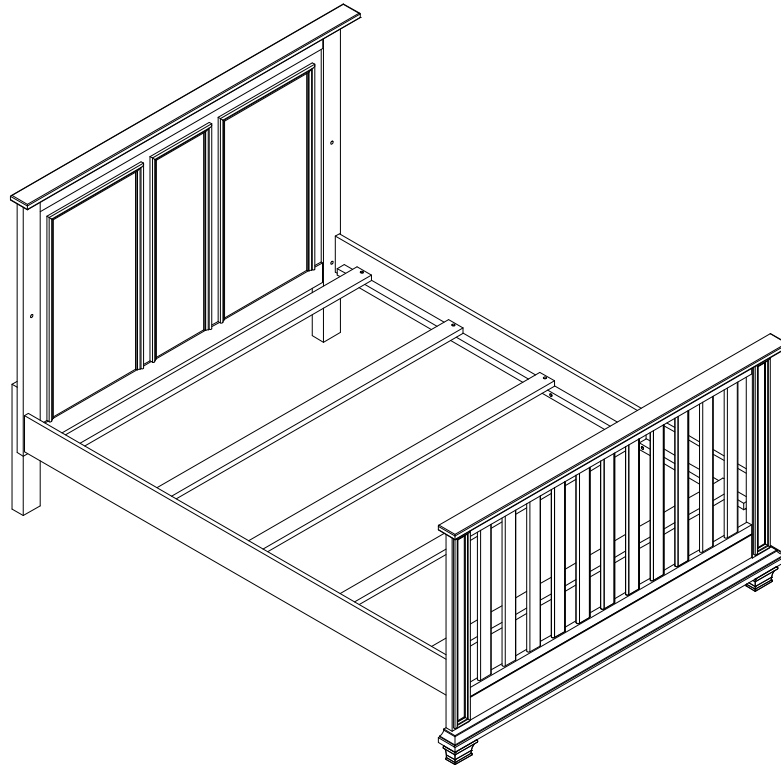

"RECOMMENDATION: We recommend the use of a Bunkie Board or box spring under a mattress for this conversion kit.

# Thank you for your purchase!

Remove all parts and hardware from the box and lay on a carpeted or scratch -free work surface.

Do not dispose of any contents until assembly is completed.

Familiarize yourself with all exhibits and diagrams to facilitate the assembly of your crib.

## TOOLS REQUIRED:

ALLEN KEY (Included)



SCREW DRIVER (Not Included)

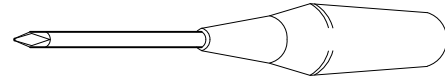

## PARTS ENCLOSED IN CARTON

A. Rail (2 pcs)

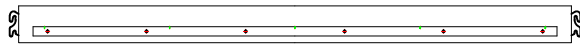

B. Slat (5 pcs)

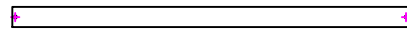

## HARDWARE

(C) AllenBolt 1"(25 mm) (2 pcs)

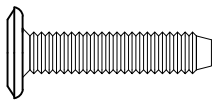

(D) Screw 1 1/4"(30 mm) (10 pcs)

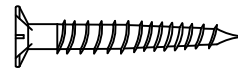

(E) Nut 3/4" (20mm) (2 pcs)

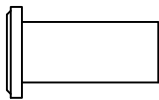

(F) Allen key (2 pcs) (length may vary)

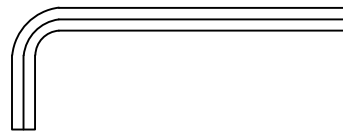

Do not fully tighten all bolts until all parts are in place.

(please add an extra 1/2 revolution to the bolts when using spring washer after tightening)

# STEP 1 " ASSEMBLY OF HEADBOARD AND FOOTBOARD"

THIS STEP REQUIRES :

- Head Board (1 pc)
- Foot Board (1 pcs)
- A. Rail (2 pcs)

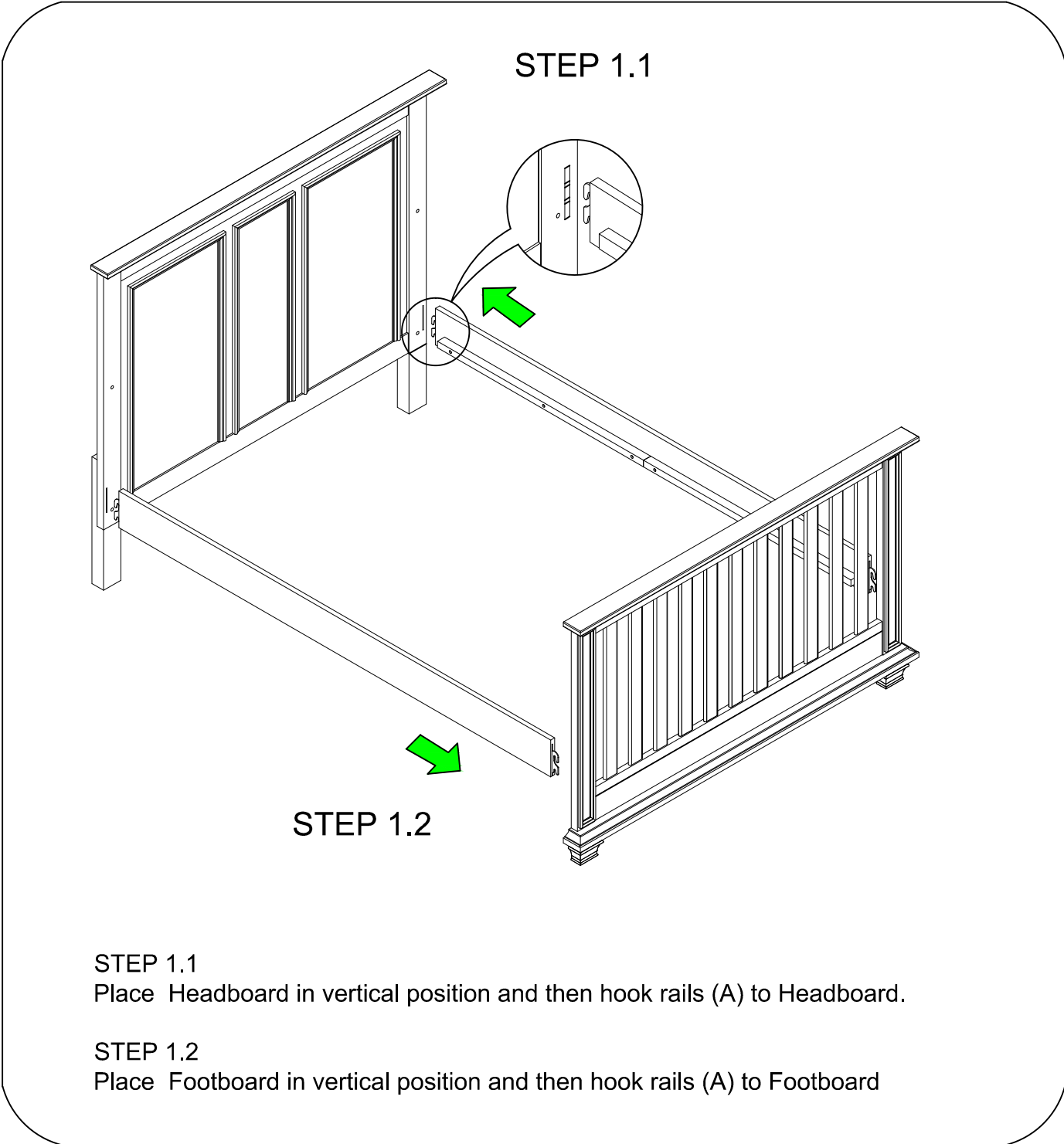

STEP 1.1

STEP 1.2

STEP 1.1  
Place Headboard in vertical position and then hook rails (A) to Headboard.

STEP 1.2  
Place Footboard in vertical position and then hook rails (A) to Footboard

## STEP 2 " ASSEMBLY OF SLATS"

THIS STEP REQUIRES :

(F) Allen key (2 pcs)

SCREW DRIVER (Not Included)

B. Slat (5 pcs)

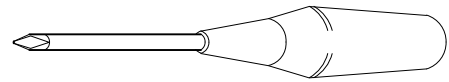

(C) Allen Bolt 1"(25 mm) (2 pcs)(D) Screw 1 1/4"(30 mm) (10 pcs)(E) Nut 3/4" (20mm) (2 pcs)

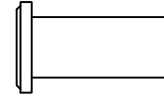
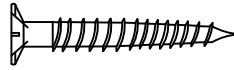
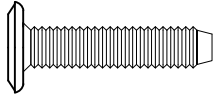

### STEP 3

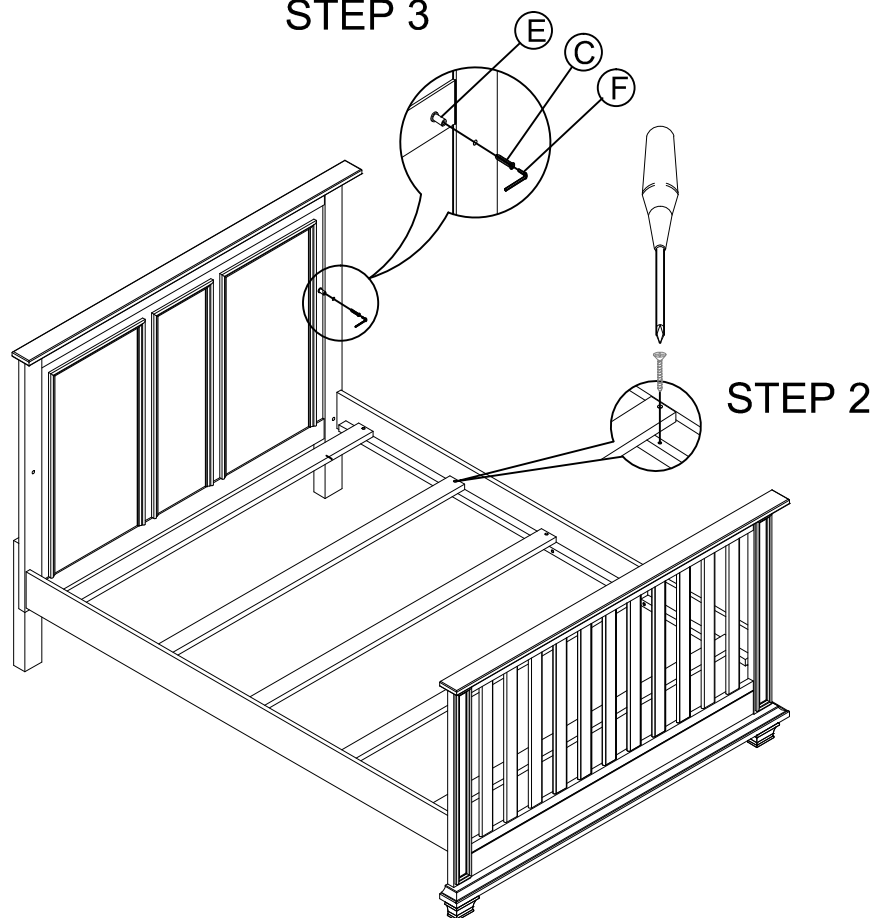

### STEP 2

- After attaching Rails (A) to headboard and footboard, place Slat (B) on the support strip of Rail (A), fasten both ends of Slat (B) with screw (D). Tighten all Screws by Screw Driver (unsupplier).

### STEP 3

- Insert Allenbolt 1" (25 mm) (C), through the top hole in the headboard from the inside and connect with nut 3/4" (20 mm) (E). Tighten all bolts and nuts with allen key (F). Assembly complete. Thanks you!

# INSTRUCTIONS DE MONTAGE pour kit de conversion de lit complet

LIT D'ENFANT UNIVERSAL CONVERTIBLE 4 EN 1  
Modèle n° 22288

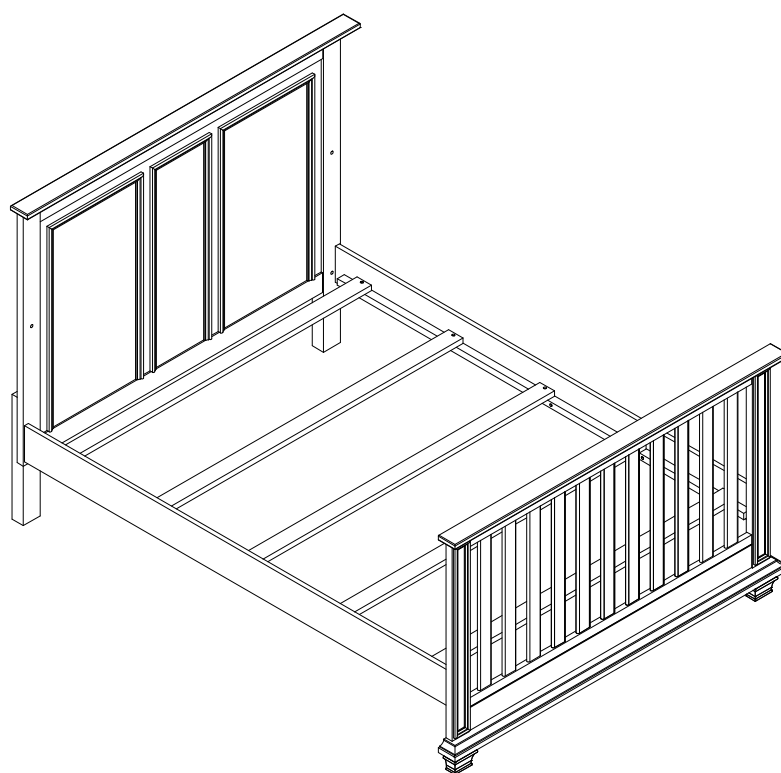

"RECOMMANDATION : nous recommandons l'utilisation d'un cadre à lattes ou d'un  
sommier sous le matelas pour ce lit complet.

# Merci pour votre achat!

Retirez toutes les pièces et le matériel de la boîte et posez-les sur une surface de travail recouverte de moquette ou sans rayures.

Ne jetez aucun contenu avant la fin du montage.

Familiarisez-vous avec toutes les pièces et les schémas pour faciliter le montage de votre lit d'enfant.

## OUTILS NÉCESSAIRES:

CLÉ ALLEN (inclus)



TOURNEVIS (non inclus)

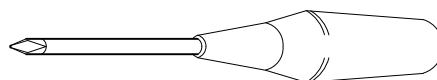

## PIÈCES INCLUSES DANS LE CARTON

A. Rail (2 pièces)



B. Lattes (5 pièces)

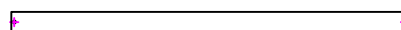

## MATÉRIEL

(C) Boulons Allen, 1 " (25 mm) (2 pièces)

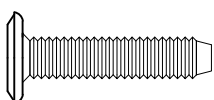

(D) Vis 1 1/4 " (30 mm) (10 pièces)

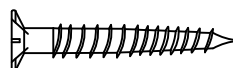

(E) Écrou 3/4 " (20mm) (2 pièces)

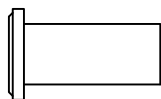

(F) Clé Allen (2 pièces) (la longueur peut varier)



Ne serrez pas complètement tous les boulons avant que toutes les pièces ne soient en place.

(veuillez ajouter un 1/2 tour supplémentaire aux boulons lors de l'utilisation de rondelle à ressort après le serrage)

# ÉTAPE 1 "MONTAGE DE LA TÊTE DE LIT ET DU PIED DE LIT"

CETTE ÉTAPE EXIGE :

- Tête de lit (1 pièce)
- Pied de lit (1 pièce)
- A. Rail (2 pièces)

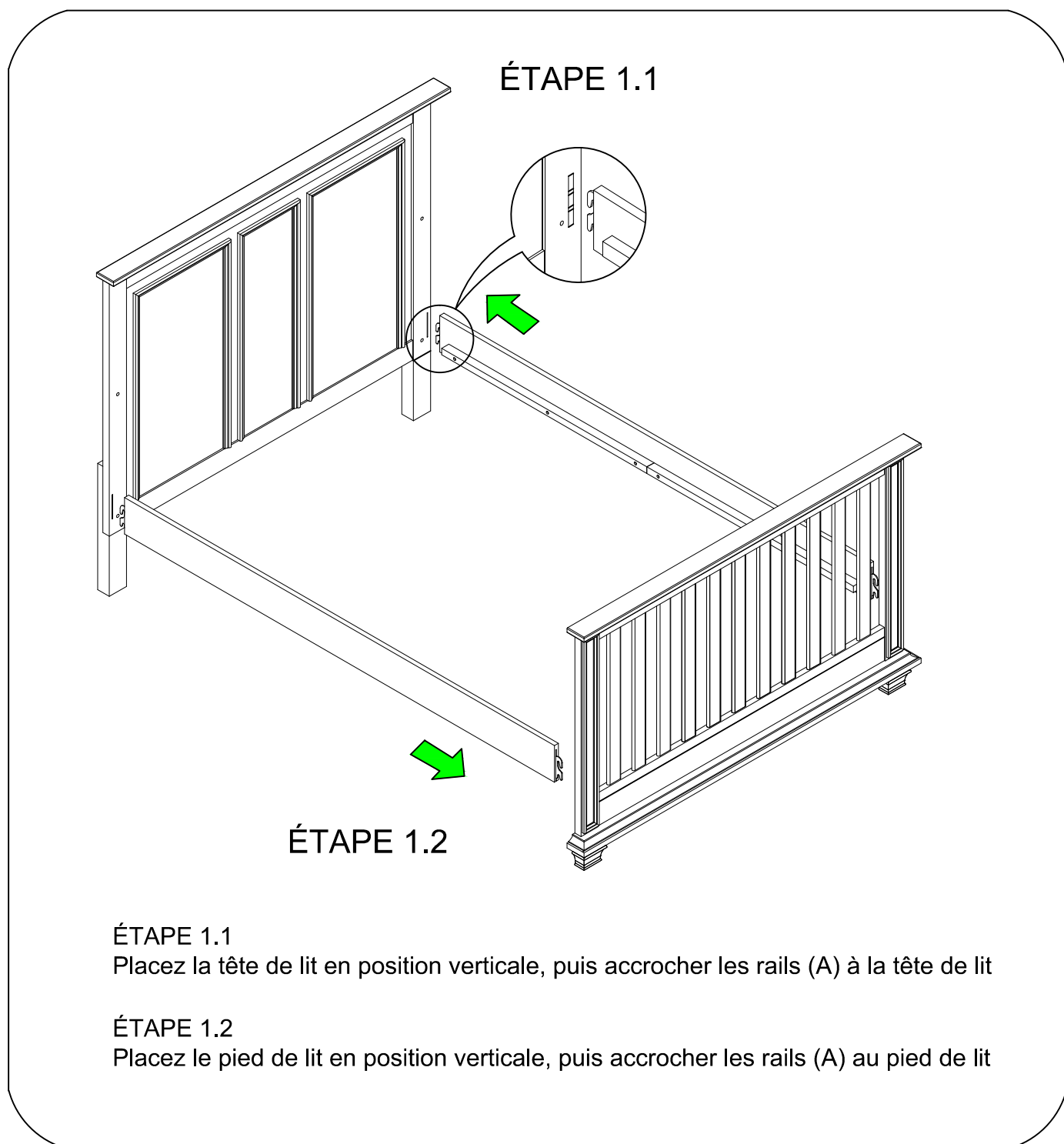

## ÉTAPE 2 "MONTAGE DES LATTES"

CETTE ÉTAPE EXIGE:

(F) Clé Allen (2 pièces)

TOURNEVIS (Non inclus)

B. Lattes (5 pièces)

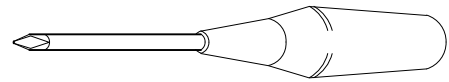

(C) Boulons Allen 1 " (25 mm) (2 pièces)

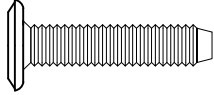

(D) Vis 1 1/4" (30 mm) (10 pièces)

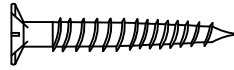

(E) Écrou 3/4 " (20 mm) (2 pièces)

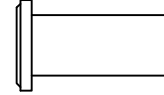

### ÉTAPE 3

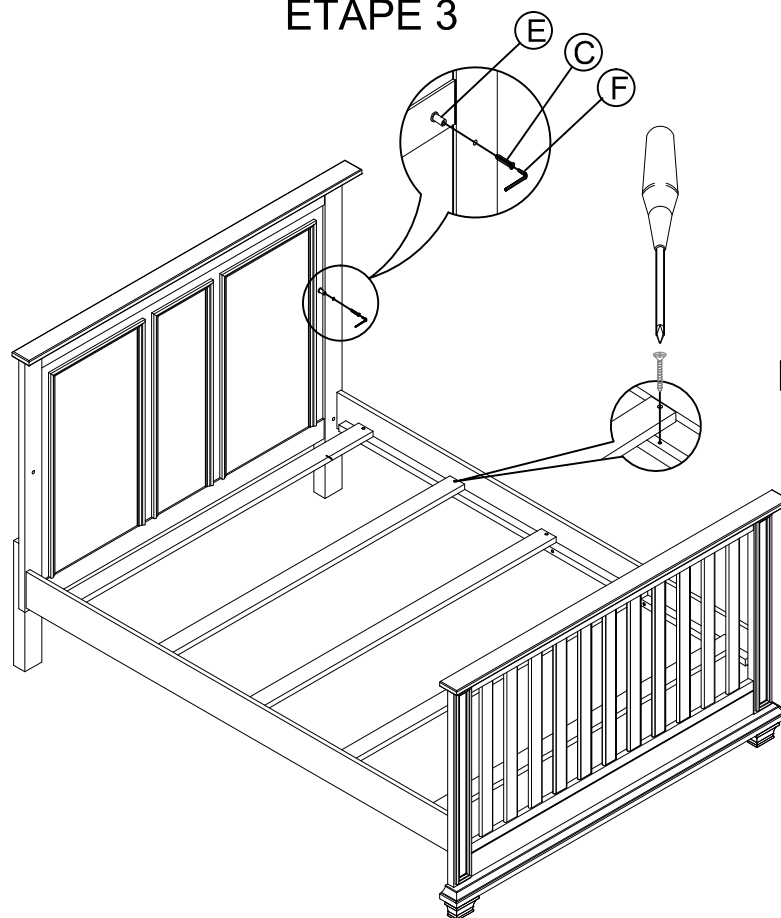

### ÉTAPE 2

#### ÉTAPE 2

- Après avoir fixé les rails (A) à la tête de lit et au pied de lit, placez la latte (B) sur la bande de support du rail (A), fixez les deux extrémités de la latte (B) avec la vis (D).  
Serrez toutes les vis avec le tournevis (non fourni).

#### ÉTAPE 3

- Insérez un boulon Allen de 1 " (25 mm) (C) dans le trou supérieur de la tête de lit de l'intérieur et branchez l'écrou de 3/4" (20 mm) (E).  
Serrez tous les boulons et écrous avec la clé Allen (F). Le montage est terminé. Je vous remercie !