

ASSEMBLY INSTRUCTIONS

**MODEL : KATE
NIGHT STAND**

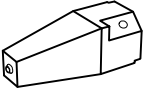

STEP 1 : Pull the top drawer and take out the Bunfoot carton (B). Attach the Bunfoot (B) at the bottom Night Stand (A) used JCBC (1)with Spring Washer (2) Flat Washer (3) and Tighten with Allen Wrench (4).

(Box 1)
BOX OF NIGHT STAND

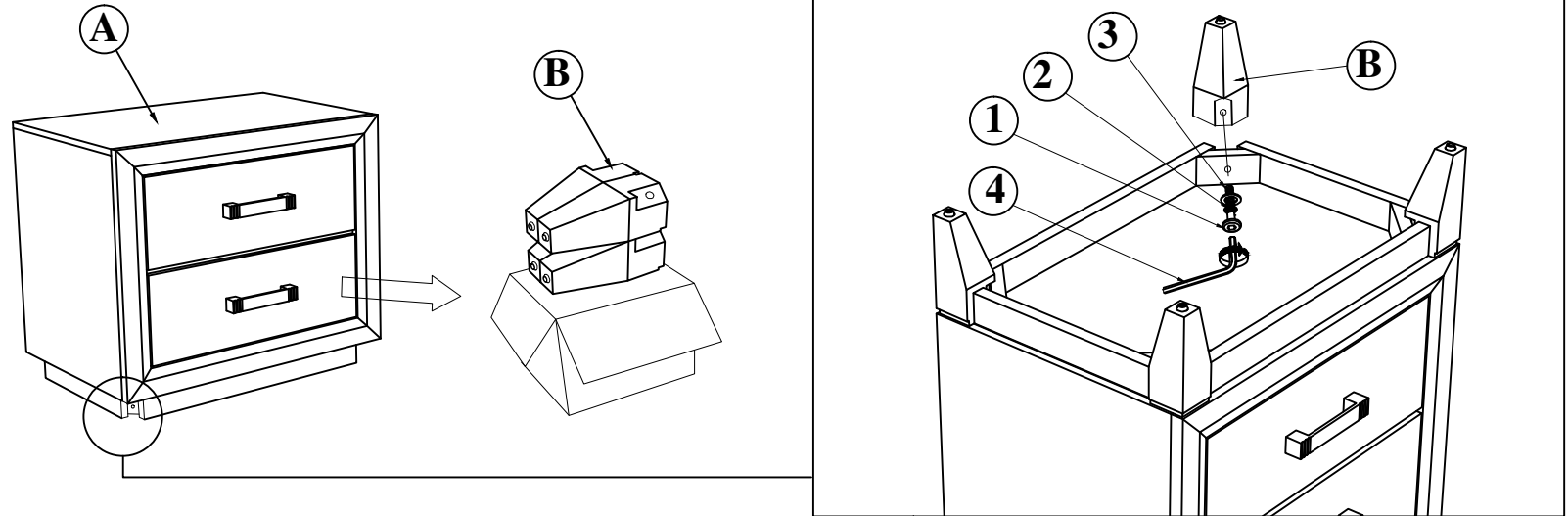
No	ITEM	Qty
A	NIGHT STAND 	1 pc
B	BUN FOOT 	4 pcs

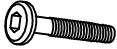

(Box 1)
HARDWARE LIST

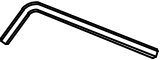
No	ITEM	Qty
1	JCBC M8 x 50mm 	4 pcs
2	SPRING WASHER 5/16" Rbw 	4 pcs
3	Flat Washer 5/16"ID x 22mmOD Blk 	4 pcs
4	ALLEN KEY m5x65mm Blk 	1 pc



COMPLETED ASSEMBLY

NOTE : MUST TIGHTEN SCREWS **PERIODICALLY** WITH USE SCREW WILL BECOME LOOSE CHECK TIGHTNESS OF ALL SCREW EVERY 6-8 WEEKS.

INSTRUCTIONS D'ASSEMBLAGE

MODÈLE : 0170A
LA TABLE DE NUIT

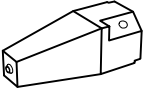

ÉTAPE 1: Tirez le tiroir et sortez le carton Bunfoot (B). Fixez le Bunfoot (B) au pied de la partie inférieure (A) utilisé JCBC (1) avec Spring Washer (2) Rondelle plate (3) et serrage avec clé Allen (4).

(Carton1)
BOITE DE NUIT

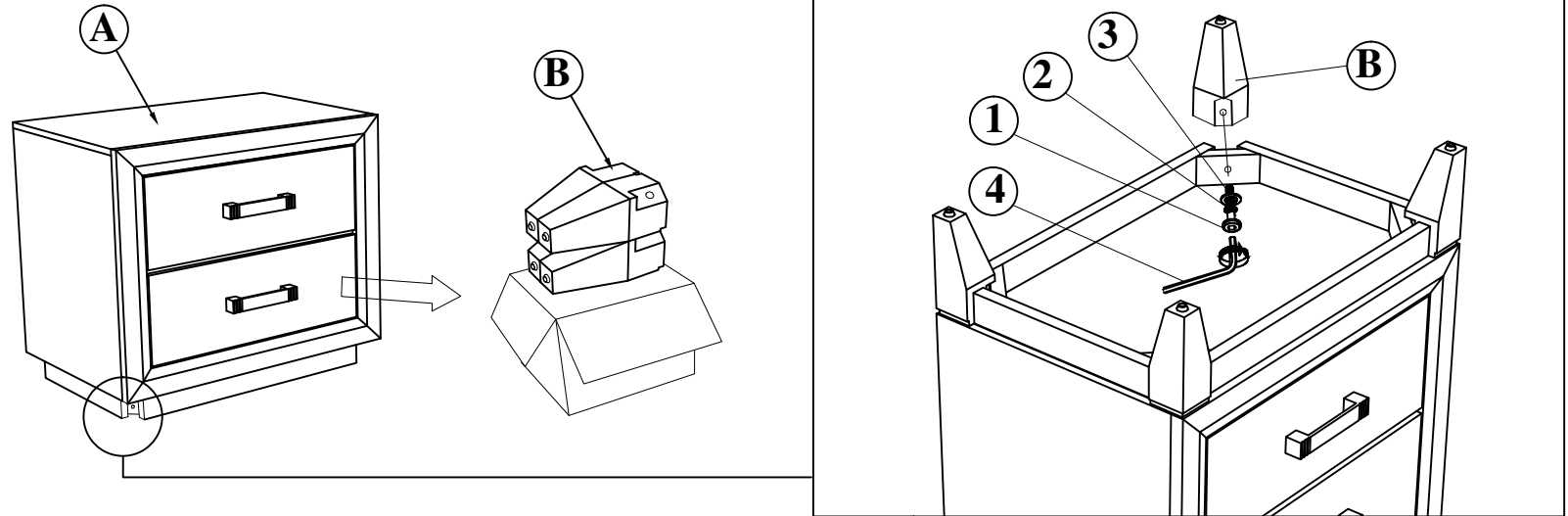
N°	Liste de Pièces	Qté
A	LA TABLE DE NUIT 	1 pce
B	Pied de pain 	4 pces

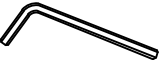

(Cart. 1)
QUINCAILLERIE

N°	Liste de Pièces	Qté
1	BOULON JCBC M6 x 50mm 	4 pces
2	Rondelle A Ressort 1/4" Rbw 	4 pces
3	Rondelle Plate 1/4" ID x 13mm OD Nre 	4 pces
4	CLÉ ALLEN m4 x 65mm NRE 	1 pce

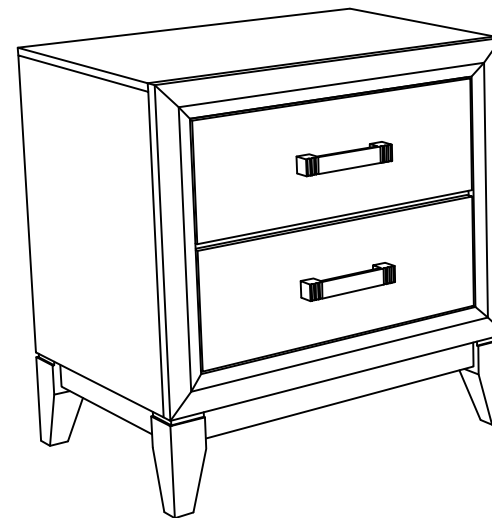

COMPLETED ASSEMBLY

REMARQUE : RESERRER LES VIS RÉGULIÈREMENT. À L'USAGE, LES VIS SE DESERRENT. VÉRIFIER QUE LES VIS SOIENT SERRÉES TOUTES LES 6-8 SEMAINES.