







ASSEMBLY INSTRUCTIONS

771-65H KING PANEL UPHOLSTERY HEADBOARD

Caution: Please read instructions thoroughly before unpacking assembly parts.

1. We recommend that you assemble this product with the assistance of another person. This will make assembly easier and help to eliminate damage to the product or injury to persons during assembly.
2. Be sure to check all packing materials carefully for small parts that may have come loose inside the carton during shipment.
3. Please put all parts on a non-abrasive surface and follow the assembly steps to assemble your newly purchased product correctly and efficiently.

NO	PARTS LIST		QTY
A		Headboard	1PC
B		Headboard Leg (L & R)	2PCS
C		Bottom Rail	1PC

NO	HARDWARE LIST		QTY
1	Flat Washer Ø1/4" x 1/2"		16PCS
2	Spring Washer Ø1/4" x 3/8"		16PCS
3	Bolt Ø1/4" x 1 3/4"		16PCS
4	Allen Key 4 x 59mm		1PC

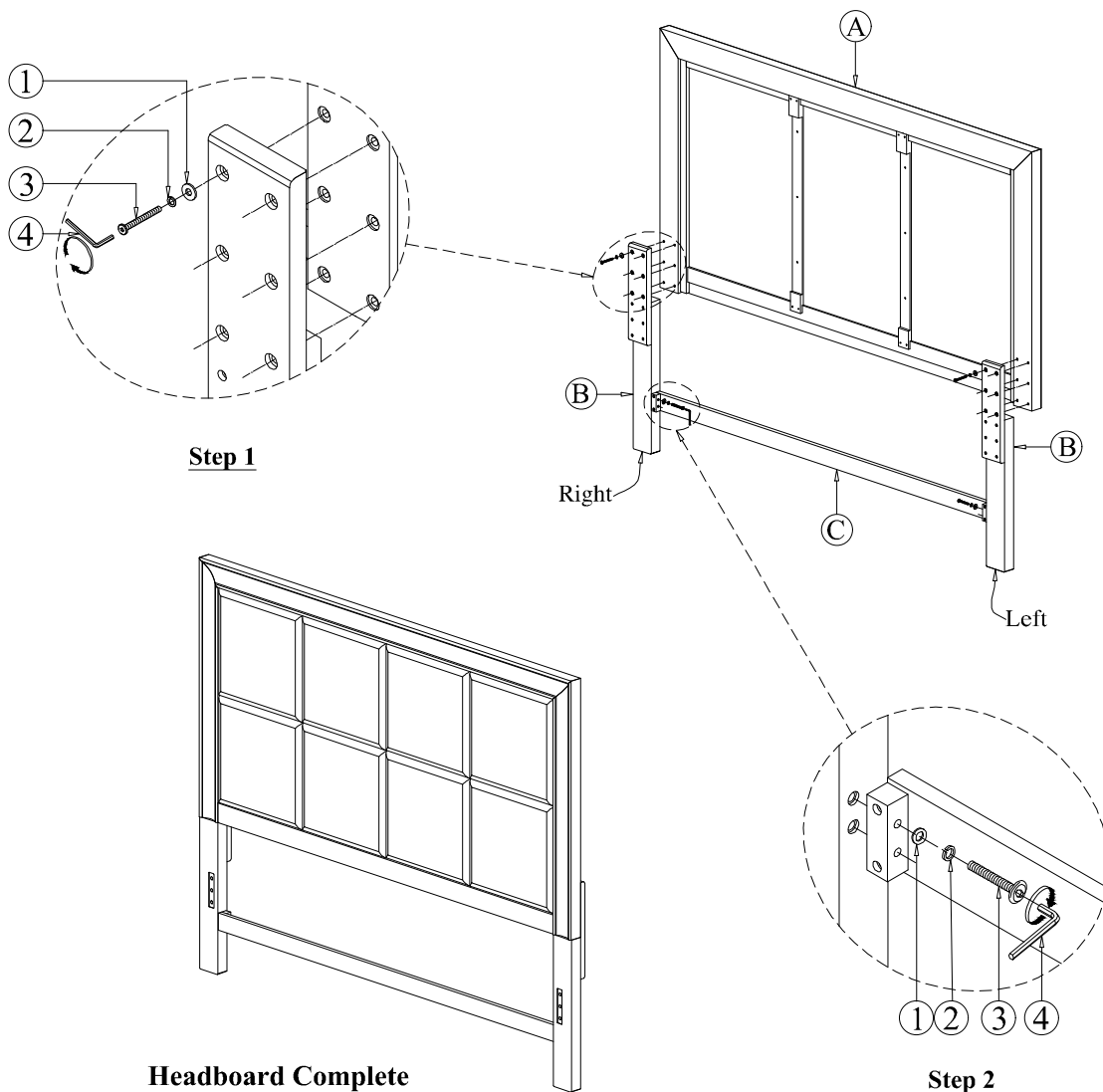























ASSEMBLY INSTRUCTIONS

771-65H/66F-ST/60R-ST KING STORAGE BED

Caution: Please read instructions thoroughly before unpacking assembly parts.

1. We recommend that you assemble this product with the assistance of another person. This will make assembly easier and help to eliminate damage to the product or injury to persons during assembly.
2. Be sure to check all packing materials carefully for small parts that may have come loose inside the carton during shipment.
3. Please put all parts on a non-abrasive surface and follow the assembly steps to assemble your newly purchased product correctly and efficiently.

NO	PARTS LIST		QTY
A		Headboard	1PC
B		Storage Footboard	1PC
C		Storage Bed Side Rail	2PCS
D		Footboard Leg (L & R)	2PCS
E		Bed Footboard Storage Drawer Slat	1PC
F		Storage Drawer Support Leg With Leveler	2PCS
G		Footboard Storage Rail With Drawer Slide	2PCS
H		Bed Storage Drawer	2PCS
I		Bed Slats (Without Support Leg)	14PCS
J		Bed Slats (With 1 Support Leg)	3PCS
		Bed Slats (With 2 Support Leg)	5PCS
K		Slat Support Leg With Leveler	13PCS

NO	HARDWARE LIST		QTY
1	Flat Washer Ø1/4" x 1/2"		4PCS
2	Spring Washer Ø1/4" x 3/8"		4PCS
3	Bolt Ø1/4" x 2"		4PCS
4	Flat Washer Ø1/4" x 3/4"		6PCS
5	Spring Washer Ø1/4" x 3/8"		6PCS
6	Bolt Ø1/4" x 1 3/8"		6PCS
7	Allen Key 4 x 59mm		1PC
8	Screw Ø4 x 30mm		46PCS
9	Screw Ø3.5 x 10mm		12PCS
Above Hardware packed in 771-66F-ST for assembly			
10	Bolt Ø5/16" x 1"		12PCS
11	Allen Key 4 x 59mm		1PC
Above Hardware packed in 771-60R-ST for assembly			

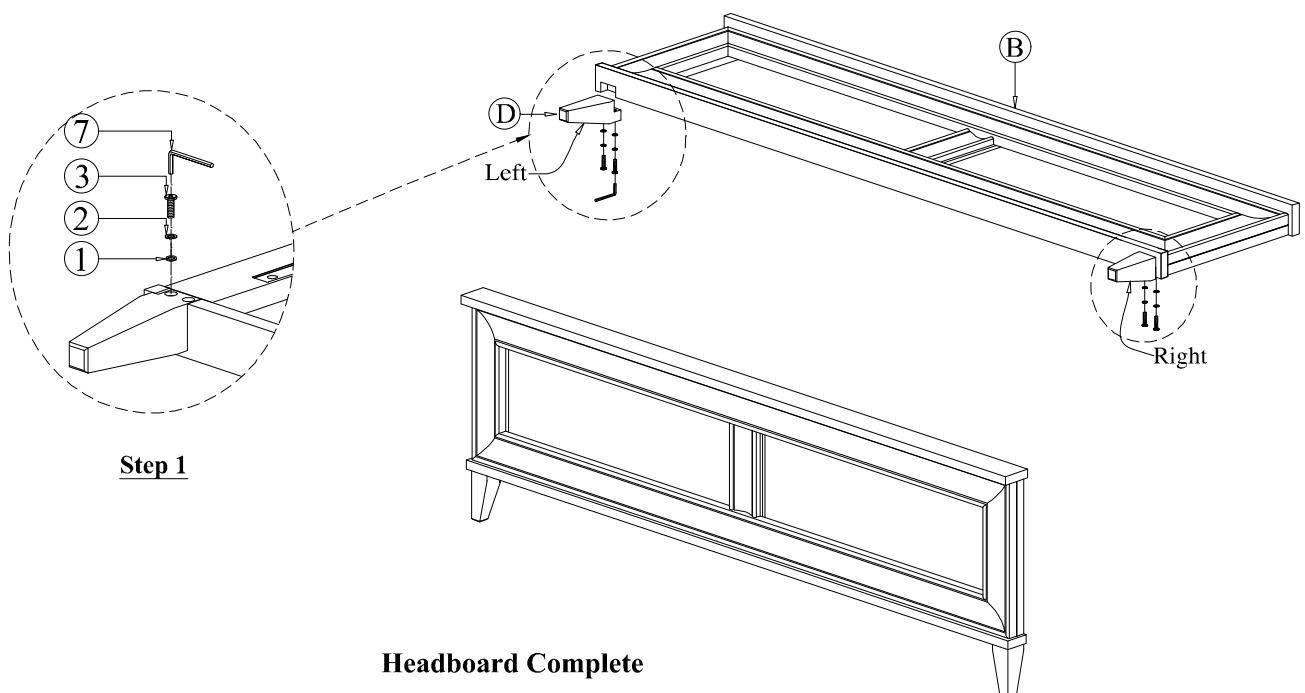

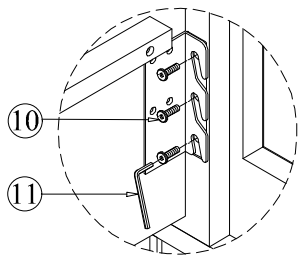

Step 2

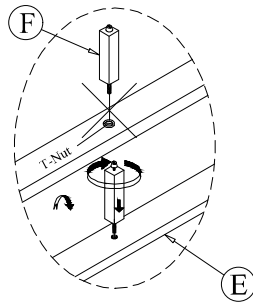

Step 3

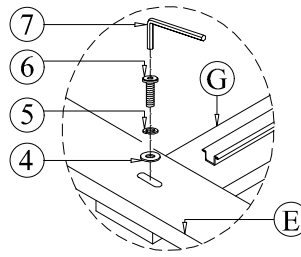

Step 4

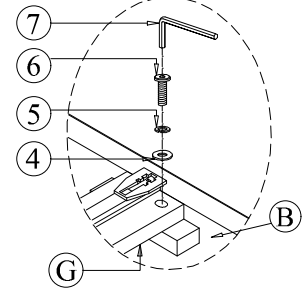

Step 5

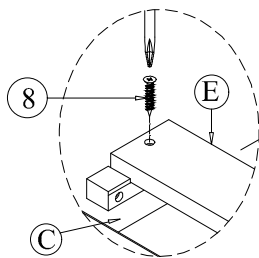

Step 6

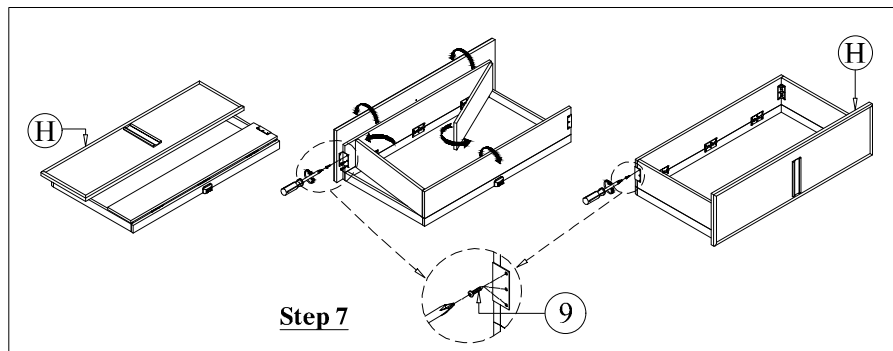

Step 7

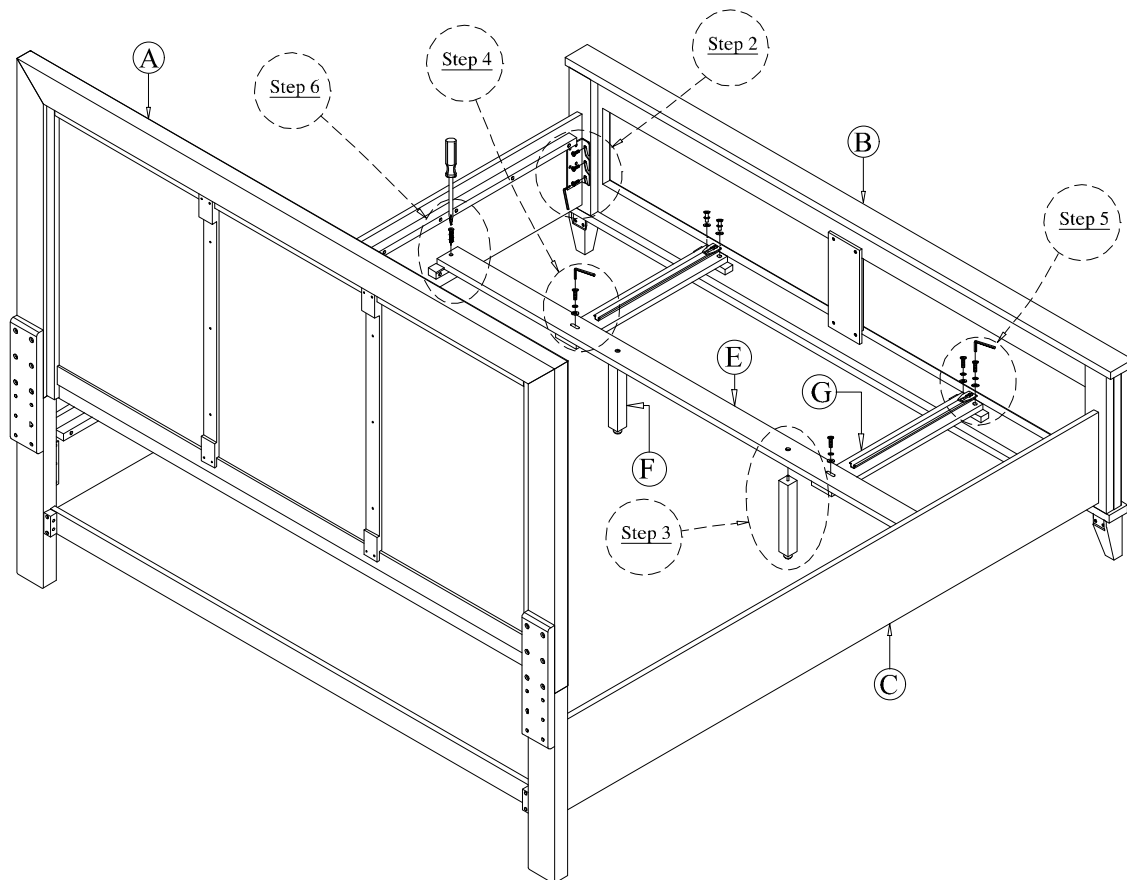

Note: If the top and bottom of the storage drawers do not fit in the footboard frame, adjust the height of the Support Leg (F) in Step 5. If the sides of the storage drawers do not fit in the footboard frame, then adjust the end position of Drawer Slide (G) in Step 6.

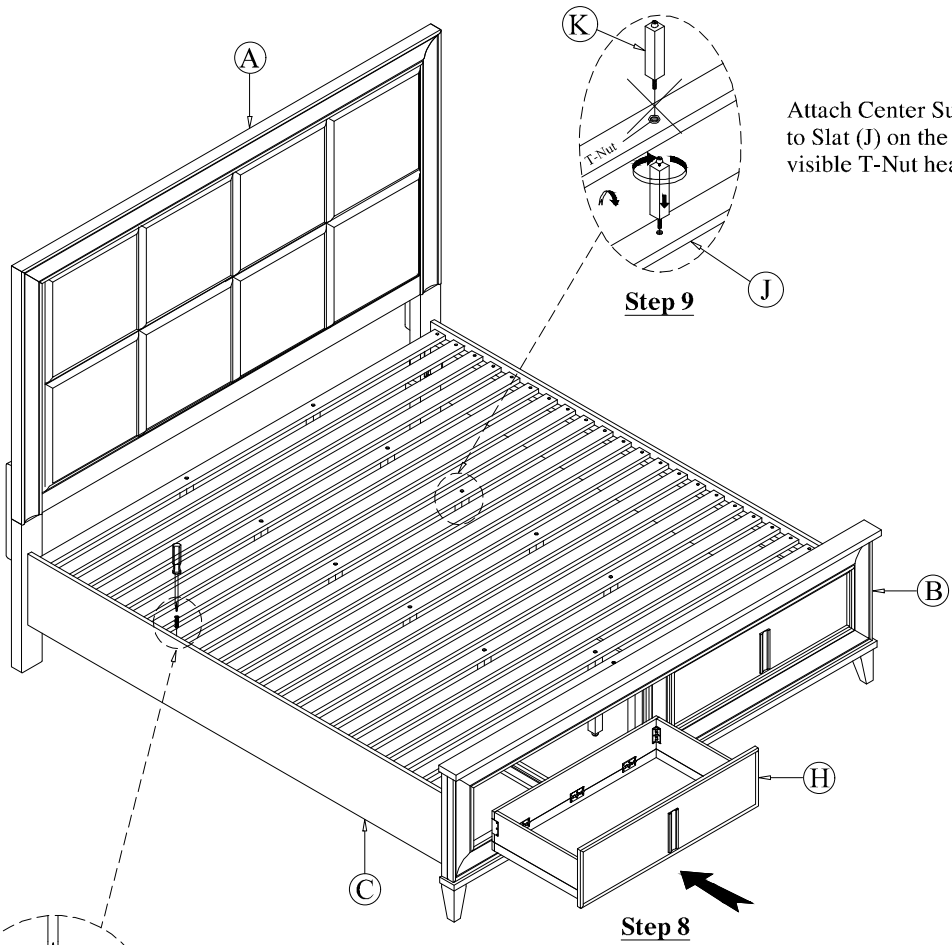

Attach Center Support Leg (K) to Slat (J) on the side with no visible T-Nut head.

Step 9

Step 8

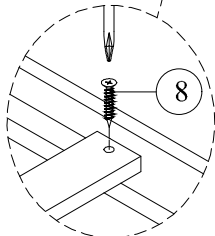

Step 10

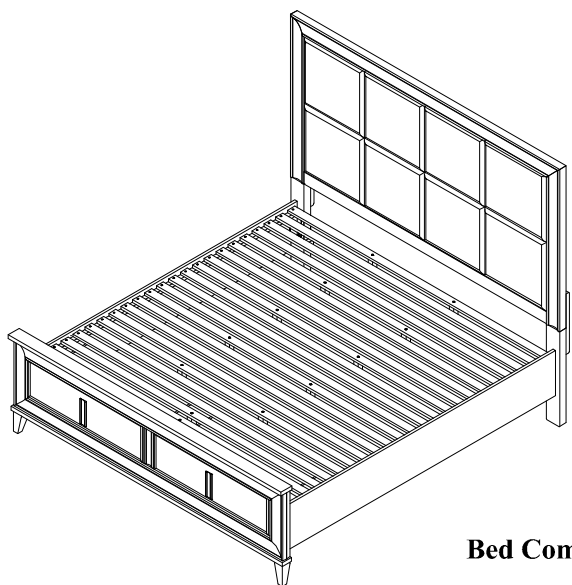
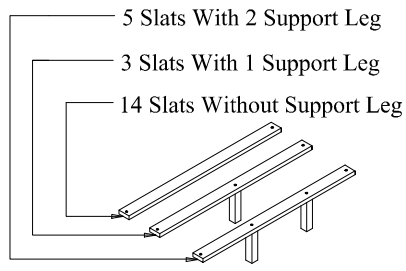

Bed Complete