







ASSEMBLY INSTRUCTIONS

771-10 DRESSER

Caution: Please read instructions thoroughly before unpacking assembly parts.

1. We recommend that you assemble this product with the assistance of another person. This will make assembly easier and help to eliminate damage to the product or injury to persons during assembly.
2. Be sure to check all packing materials carefully for small parts that may have come loose inside the carton during shipment.
3. Please put all parts on a non-abrasive surface and follow the assembly steps to assemble your newly purchased product correctly and efficiently.

NO	PARTS LIST		QTY	NO	HARDWARE LIST		QTY
A		DRESSER	1PC	1	Flat Washer Ø1/4" x 3/4"		8PCS
B		LEGS	4PCS	2	Spring Washer Ø1/4" x 3/8"		8PCS
C		SUPPORT LEG	1PC	3	Bolt Ø1/4" x 2"		8PCS
				4	Allen Key 4 x 59mm		1PC

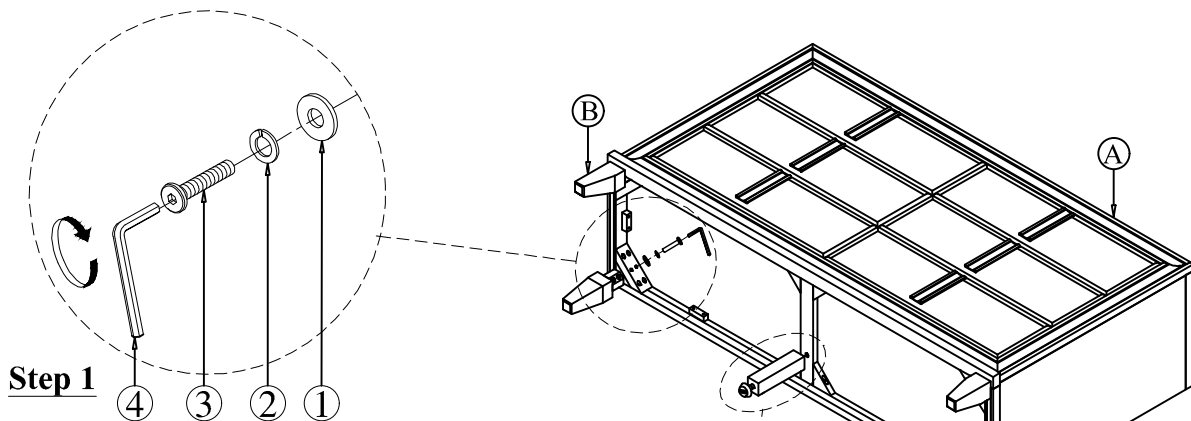

Tipping Restraint

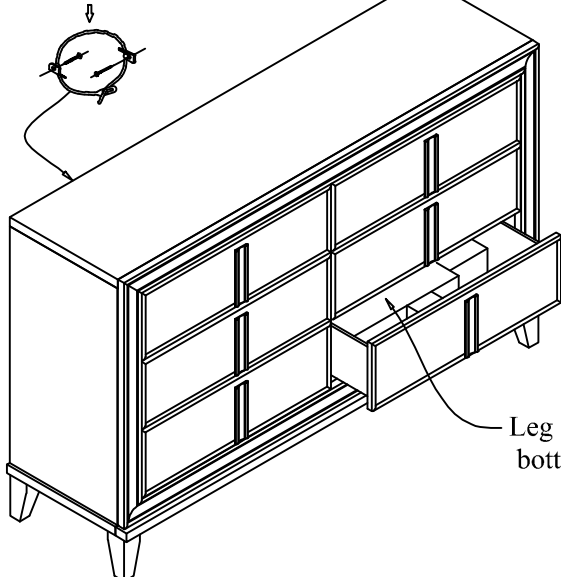

Leg carton packed in bottom drawer

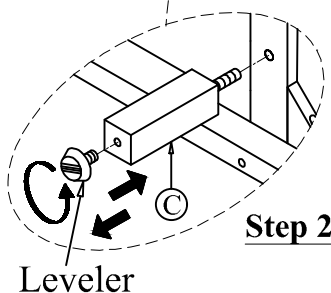

NOTE

A tipping restraint hardware kit is included with this product. Refer to the installation instructions in the hardware pack.