



INSTRUCTIONS D'ASSEMBLAGE
ASSEMBLY INSTRUCTIONS

MONARCH
SPECIALTIES INC.

I 7245

BUREAU -
60"L / NATUREL / METAL ARGENT

COMPUTER DESK -
60"L / NATURAL WITH SILVER METAL



**POUR DE L'ASSISTANCE OU POUR COMMANDER
DES PIÈCES CONTACTEZ NOTRE DÉPARTEMENT
DE SERVICE À LA CLIENTÈLE.**

**FOR ASSISTANCE OR TO ORDER PARTS
CONTACT OUR CUSTOMER SERVICE DEPARTMENT**

WWW.MONARCHSERVICE.COM

LISTE DES PIÈCES
PARTS LIST

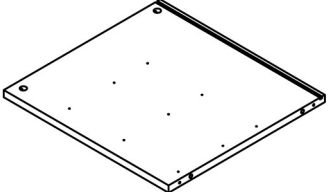
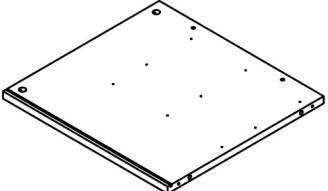
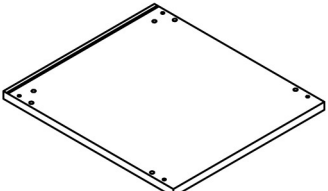
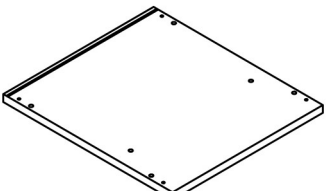
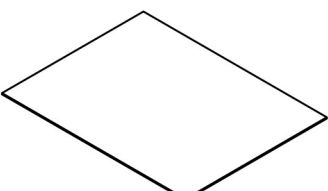
PIÈCE / PART #	IMAGE	DESCRIPTION	QTY / QTÉ
1		FRONT FACING LEFT SIDE PANEL PANNEAU DE CÔTÉ GAUCHE	1
2		FRONT FACING RIGHT SIDE PANEL PANNEAU DE CÔTÉ AVANT DROIT	1
3		BOTTOM PANEL PANNEAU DU BAS	1
4		TOP PANEL PANNEAU DE SURFACE	1
5		BACK PANEL PANNEAU ARRIÈRE	1

LISTE DES PIÈCES
PARTS LIST

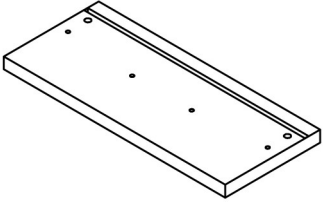
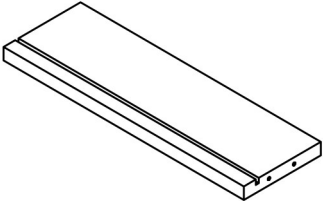
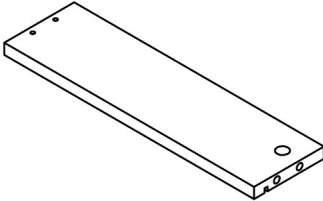
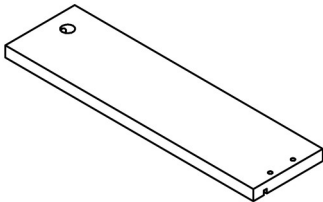
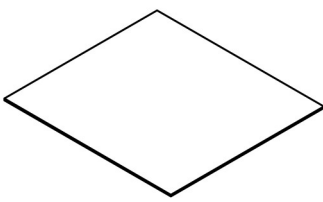
PIÈCE / PART #	IMAGE	DESCRIPTION	QTY / QTÉ
6		DRAWER FRONT PANEL PANNEAU AVANT TIROIR	3
7		DRAWER BACK PANEL PANNEAU ARRIÈRE TIROIR	3
8		DRAWER SIDE PANEL PANNEAU DE CÔTÉ TIROIR	3
9		DRAWER SIDE PANEL PANNEAU DE CÔTÉ TIROIR	3
10		DRAWER BOTTOM PANEL PANNEAU DU BAS TIROIR	3

LISTE DES PIÈCES
PARTS LIST

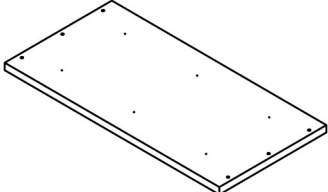
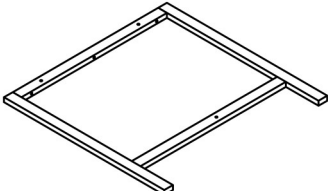
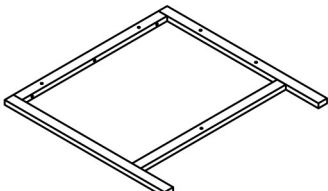
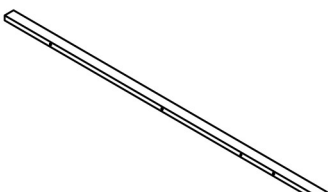
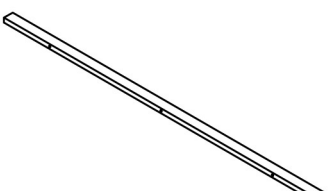
PIÈCE / PART #	IMAGE	DESCRIPTION	QTY / QTÉ
11		DESK TOP SURFACE DU BUREAU	1
12		FRONT FACING LEFT LEG PATTE AVANT GAUCHE	1
13		FRONT FACING RIGHT LEG PATTE AVANT DROITE	1
14		CROSSBAR BARRE TRANSVERSALE	1
15		CROSSBAR BARRE TRANSVERSALE	1

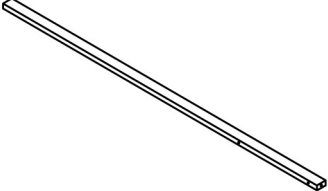

LISTE DES PIÈCES
PARTS LIST

PIÈCE / PART #	IMAGE	DESCRIPTION	QTY / QTÉ
16		CROSSBAR BARRE TRANSVERSALE	1

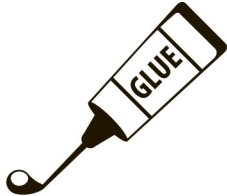
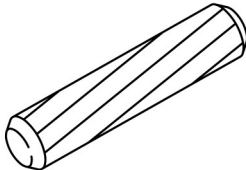
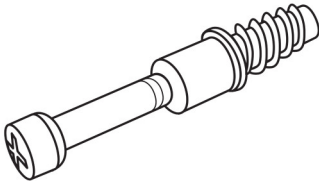
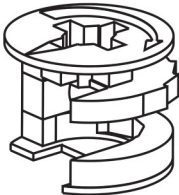
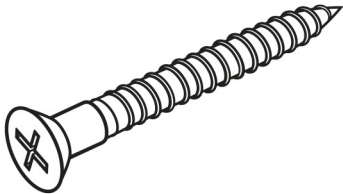
LISTE DES PIÈCES DE MONTAGE
HARDWARE LIST

PIÈCE / PART #	IMAGE	DESCRIPTION	QTY / QTÉ
A		GLUE - 15G COLLE - 15G	1
B		WOOD DOWEL - Ø3/8" X 1 1/8" GOUJON DE BOIS - Ø3/8" X 1 1/8"	14
C		CAM LOCK SCREW - 1 3/8" VIS CAM LOCK - 1 3/8"	10
D		CAM LOCK CONNECTOR - Ø5/8" X 1/2" ÉCROU CAM LOCK - Ø5/8" X 1/2"	10
E		ASSEMBLING SCREW - 1 5/8" VIS D'ASSEMBLAGE - 1 5/8"	4

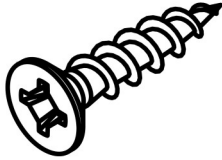
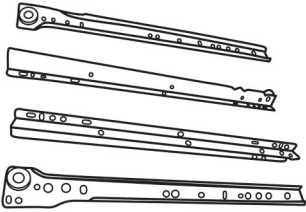
LISTE DES PIÈCES DE MONTAGE
HARDWARE LIST

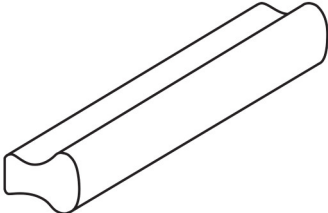
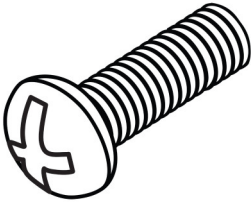
PIÈCE / PART #	IMAGE	DESCRIPTION	QTY / QTÉ
F		ASSEMBLING SCREW - 1 3/8" VIS D'ASSEMBLAGE - 1 3/8"	12
G		METAL DRAWER SLIDE - 13 3/4" COULISSE DE MÉTAL - 13 3/4"	3
H		ASSEMBLING SCREW - 1/2" VIS D'ASSEMBLAGE - 1/2"	42
I		HANDLE - 4 3/4" POIGNÉE - 4 3/4"	3
J		ASSEMBLING BOLT - 1 1/8" BOULON D'ASSEMBLAGE - 1 1/8"	6

LISTE DES PIÈCES DE MONTAGE
HARDWARE LIST

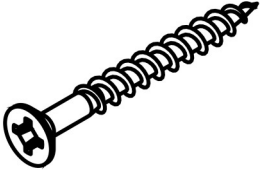
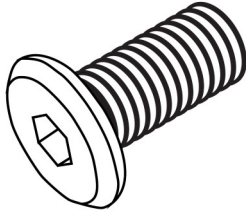
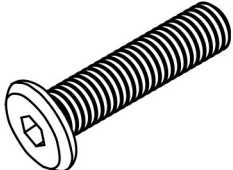
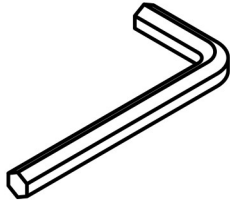
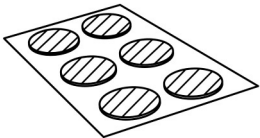
PIÈCE / PART #	IMAGE	DESCRIPTION	QTY / QTÉ
K		ASSEMBLING SCREW - 2 1/2" VIS D'ASSEMBLAGE - 2 1/2"	6
L		ASSEMBLING BOLT - 1 1/8" BOULON D'ASSEMBLAGE - 1 1/8"	6
M		ASSEMBLING BOLT - 2 1/2" BOULON D'ASSEMBLAGE - 2 1/2"	12
N		HEX KEY CLÉ HEXAGONALE	1
O		FINISHING STICKER - Ø3/4" COLLANT DE FINITION - Ø3/4"	10

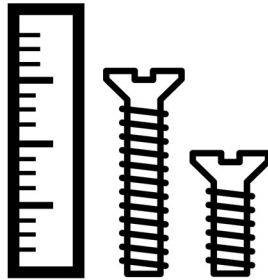

OUTIL DE VÉRIFICATION DE DIMENSIONS DES PIÈCES
HARDWARE DIMENSIONS VERIFICATION TOOL

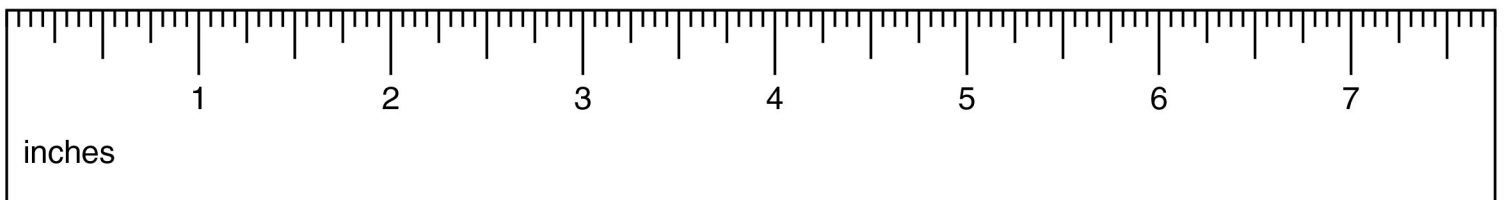

ÉTAPE / STEP 1

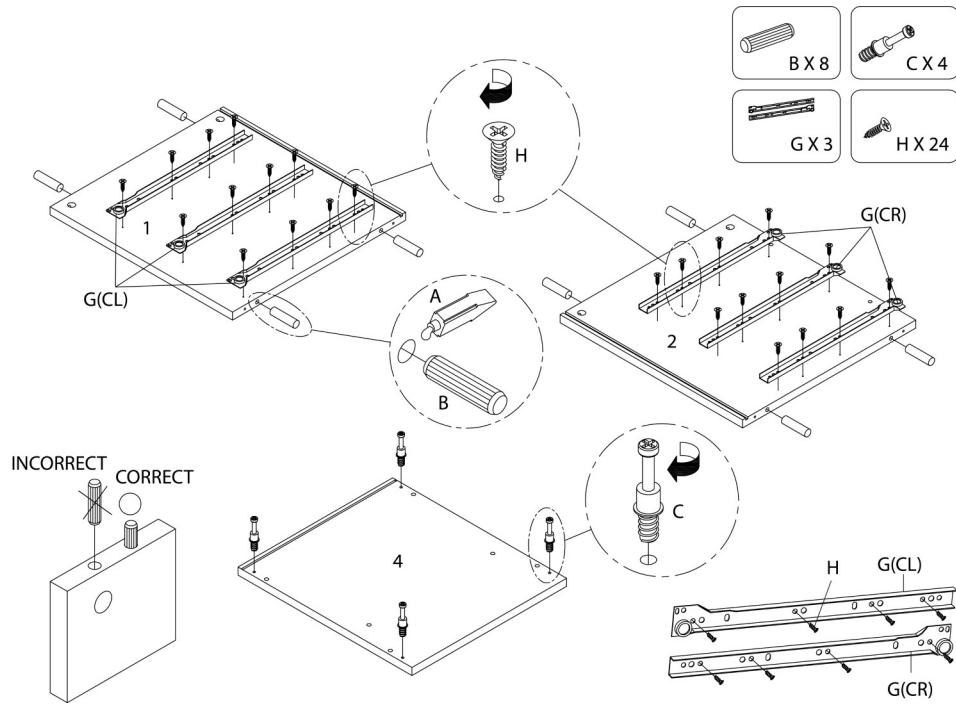

ÉTAPE / STEP 2

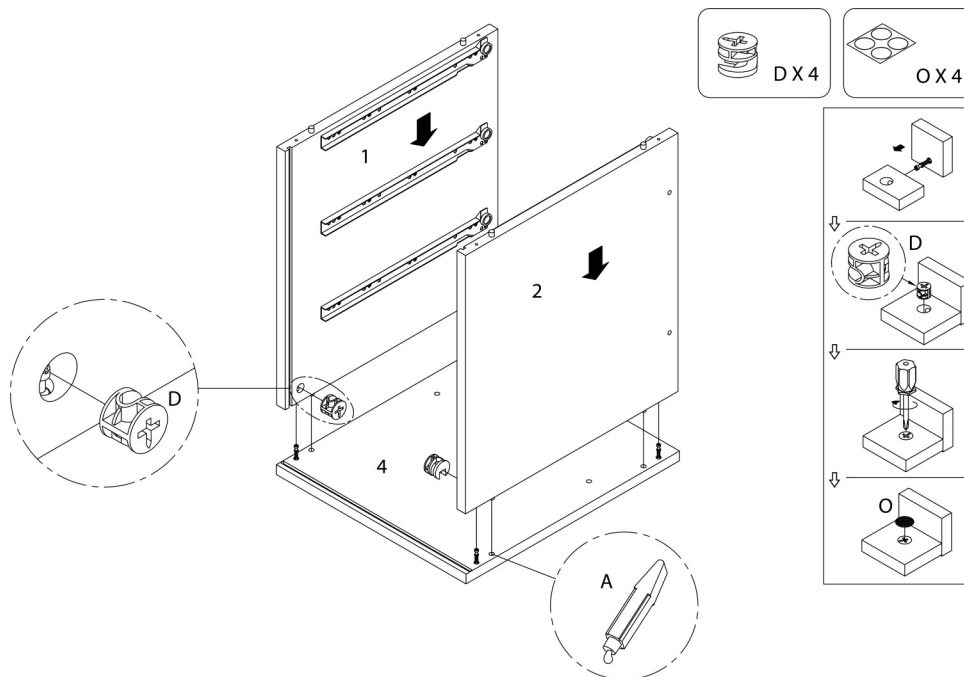

ÉTAPE / STEP 3

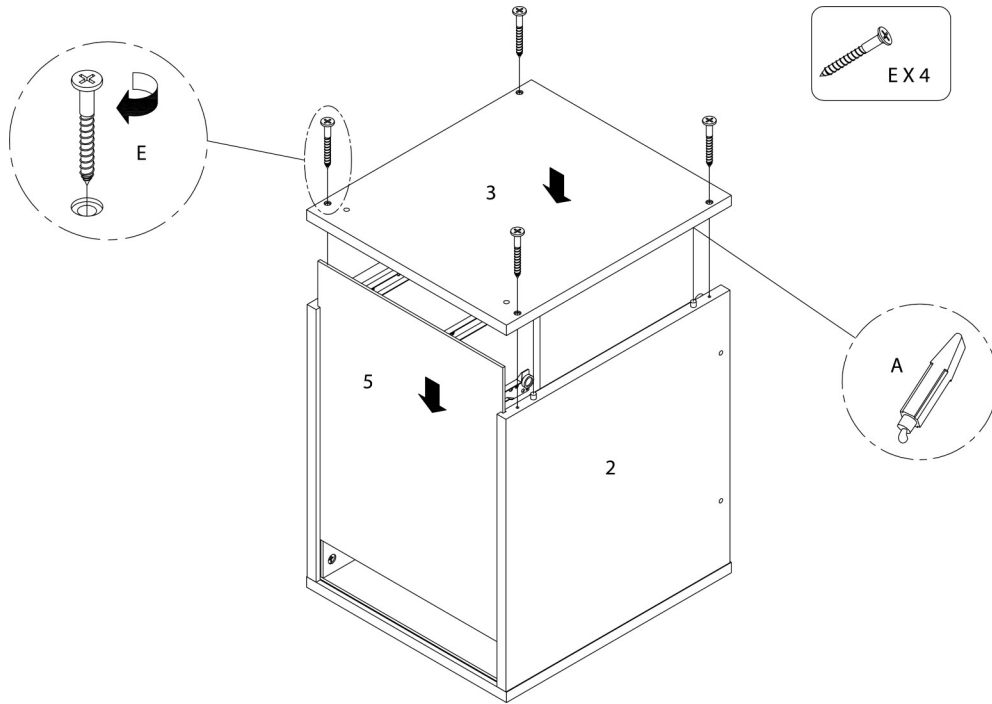

ÉTAPE / STEP 4

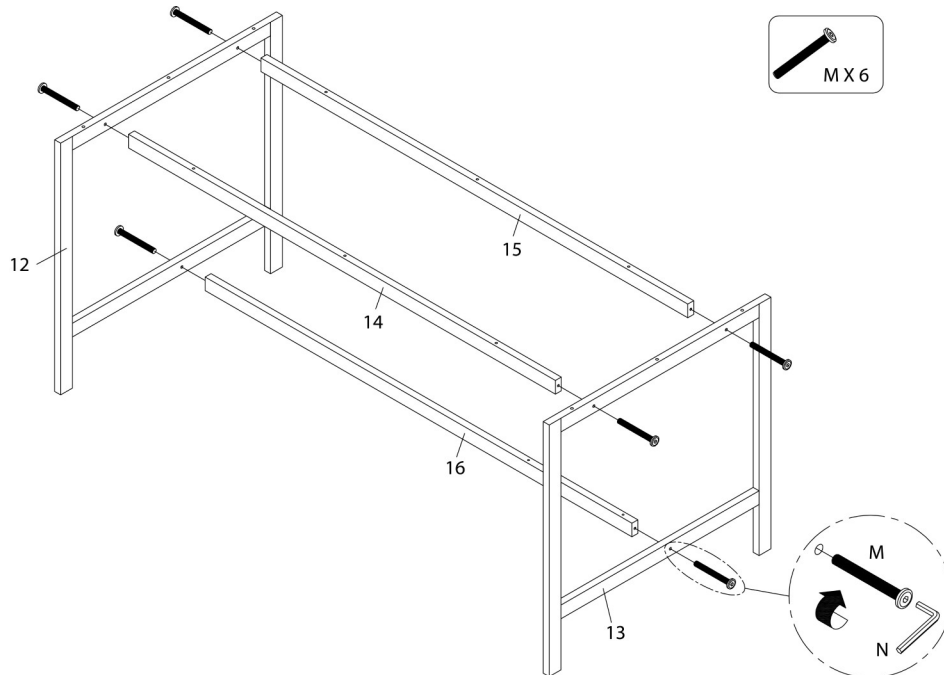

ÉTAPE / STEP 5

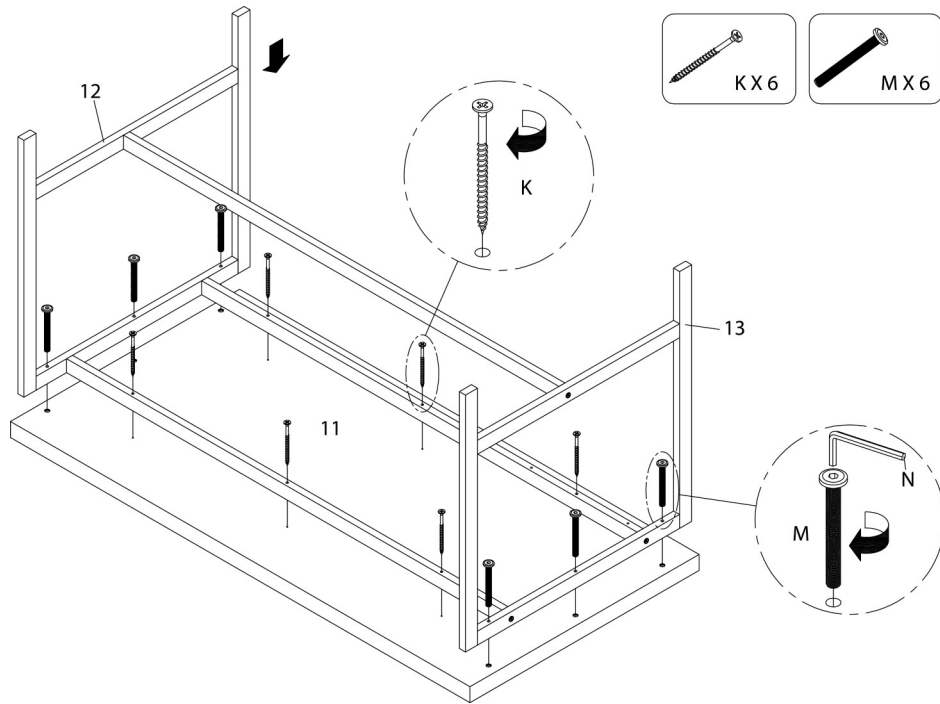

ÉTAPE / STEP 6

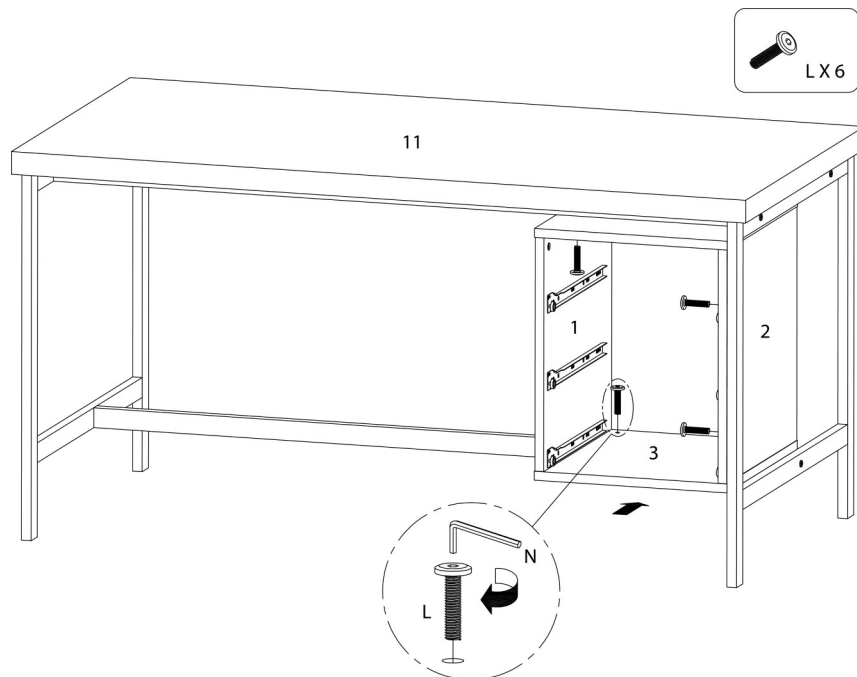

ÉTAPE / STEP 7

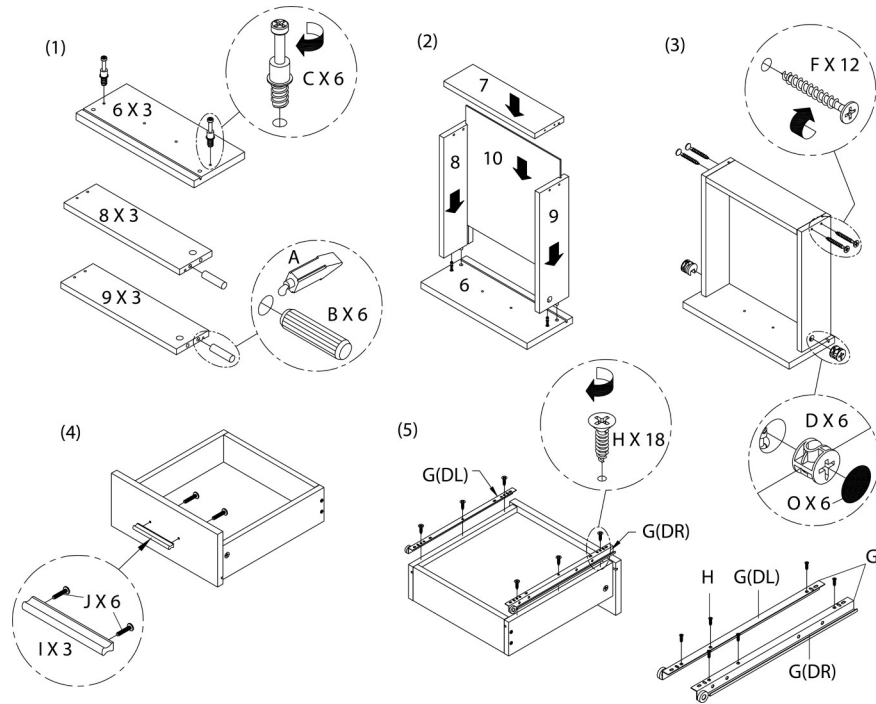

ÉTAPE / STEP 8

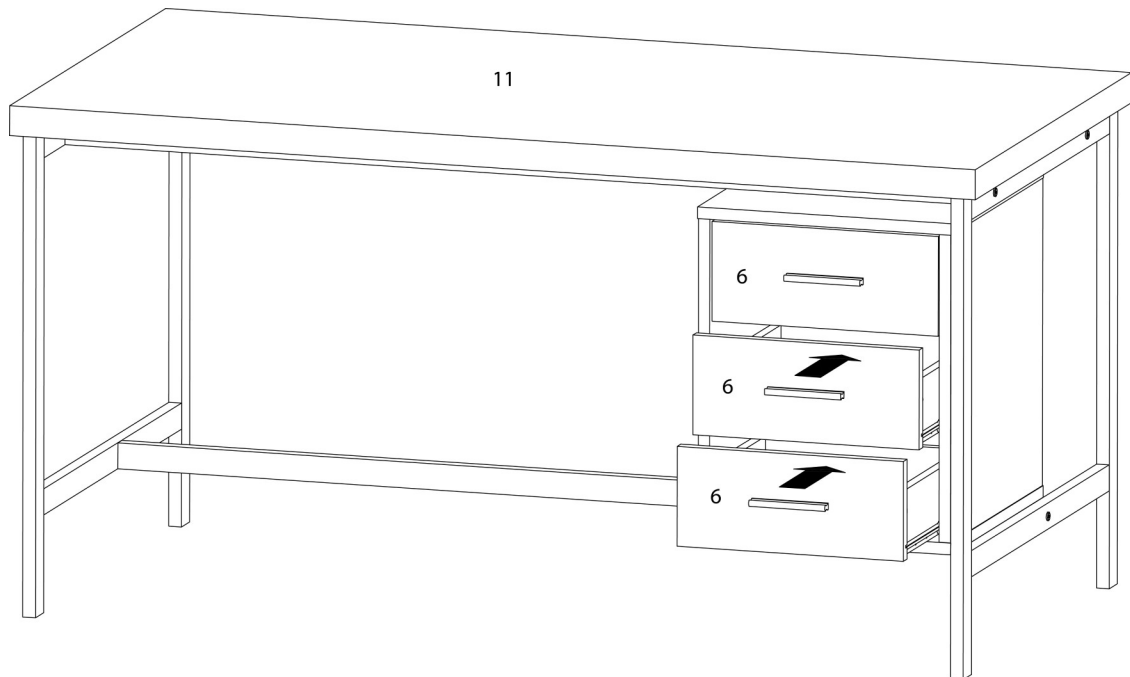

ÉTAPE / STEP 9

