



INSTRUCTIONS D'ASSEMBLAGE
ASSEMBLY INSTRUCTIONS

MONARCH
SPECIALTIES INC.

I 7205

BUREAU -
48" L / BLANC LUSTRE / METAL CHROME

COMPUTER DESK -
48" L / GLOSSY WHITE / CHROME METAL





**POUR DE L'ASSISTANCE OU POUR COMMANDER
DES PIÈCES CONTACTEZ NOTRE DÉPARTEMENT
DE SERVICE À LA CLIENTÈLE.**

**FOR ASSISTANCE OR TO ORDER PARTS
CONTACT OUR CUSTOMER SERVICE DEPARTMENT**

WWW.MONARCHSERVICE.COM

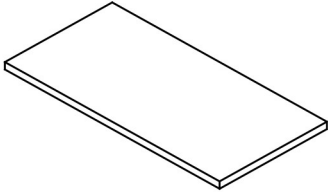
LISTE DES PIÈCES
PARTS LIST

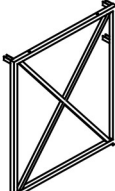
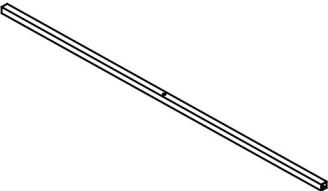
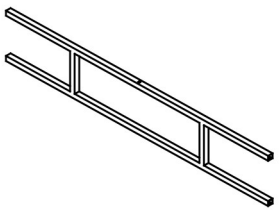
PIÈCE / PART #	IMAGE	DESCRIPTION	QTY / QTÉ
1		<p align="center">DESK TOP SURFACE DU BUREAU</p>	1
2		<p align="center">FRONT FACING LEFT LEG PATTE AVANT GAUCHE</p>	1
3		<p align="center">FRONT FACING RIGHT LEG PATTE AVANT DROITE</p>	1
4		<p align="center">SUPPORT BAR BARRE DE SOUTIEN</p>	1
5		<p align="center">BACK FRAME CADRE DU DOSSIER</p>	1

LISTE DES PIÈCES DE MONTAGE
HARDWARE LIST

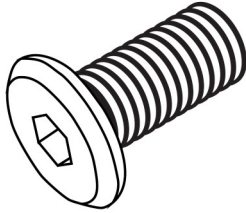
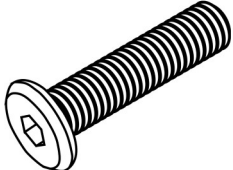
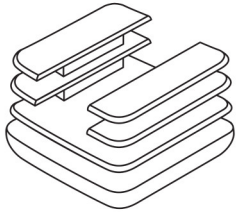
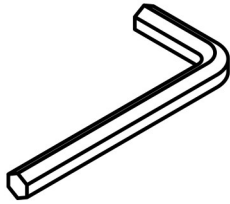
PIÈCE / PART #	IMAGE	DESCRIPTION	QTY / QTÉ
A		<p align="center">ASSEMBLING BOLT - Ø1/4" X 1/2"</p> <p align="center">BOULON D'ASSEMBLAGE - Ø1/4" X 1/2"</p>	12
B		<p align="center">ASSEMBLING BOLT - Ø1/4" X 1 1/4"</p> <p align="center">BOULON D'ASSEMBLAGE - Ø1/4" X 1 1/4"</p>	6
C		<p align="center">FLOOR PROTECTOR - 3/4" X 3/4"</p> <p align="center">PROTECTEUR DE PLANCHER - 3/4" X 3/4"</p>	4
D		<p align="center">HEX KEY</p> <p align="center">CLÉ HEXAGONALE</p>	1



OUTIL DE VÉRIFICATION DE DIMENSIONS DES PIÈCES
HARDWARE DIMENSIONS VERIFICATION TOOL



ÉTAPE / STEP 1

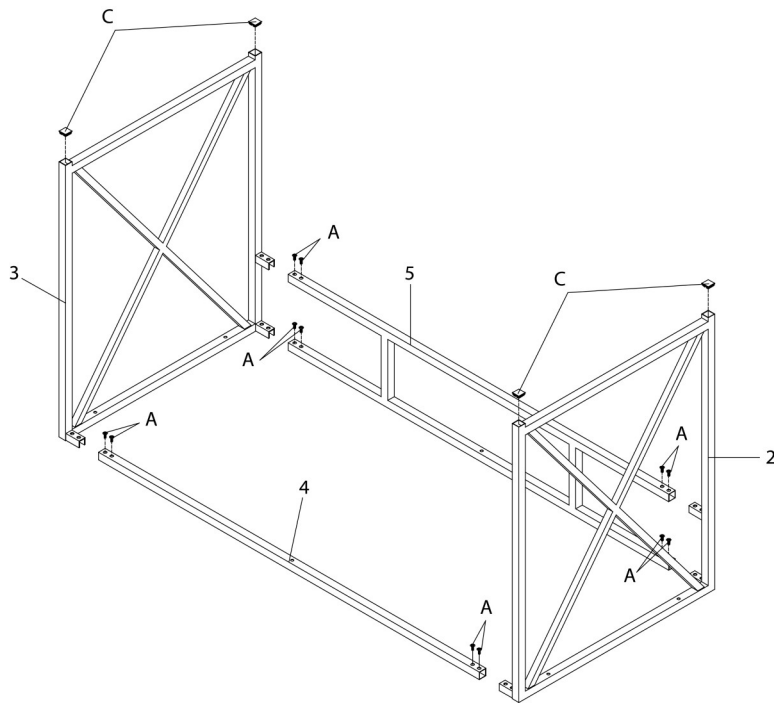

ÉTAPE / STEP 2

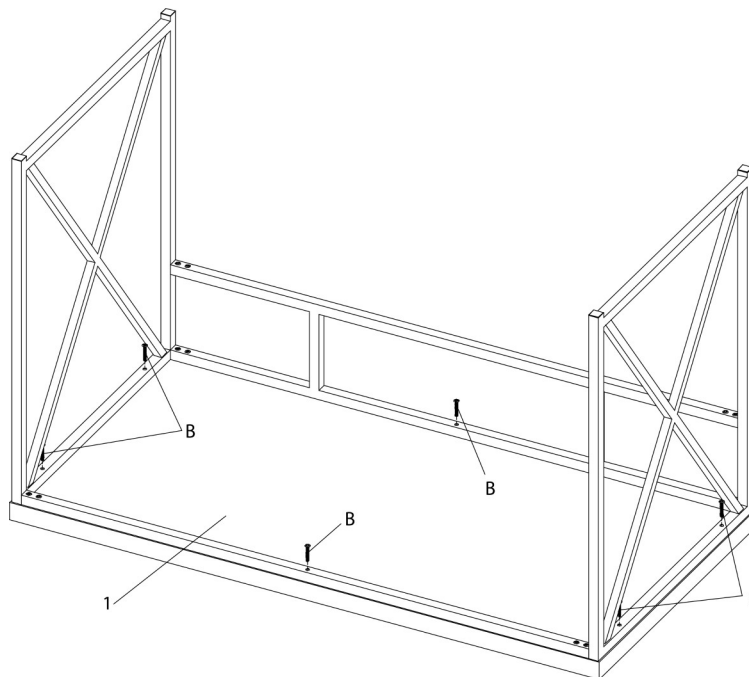

ÉTAPE / STEP 3

