



**INSTRUCTIONS D'ASSEMBLAGE  
ASSEMBLY INSTRUCTIONS**

---

**M**ONARCH  
SPECIALTIES INC.

# I 7004

---

**CREDESCENCE -  
ESPRESSO / 2 TIROIRS SUR ROULETTES**

**OFFICE CABINET -  
ESPRESSO 2 DRAWER ON CASTORS**



**POUR DE L'ASSISTANCE OU POUR COMMANDER  
DES PIÈCES CONTACTEZ NOTRE DÉPARTEMENT  
DE SERVICE À LA CLIENTÈLE.**

**FOR ASSISTANCE OR TO ORDER PARTS  
CONTACT OUR CUSTOMER SERVICE DEPARTMENT**

**WWW.MONARCHSERVICE.COM**

**LISTE DES PIÈCES**  
**PARTS LIST**

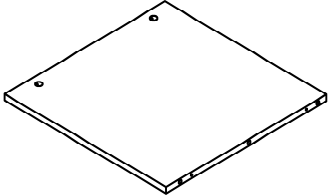
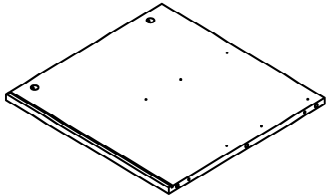
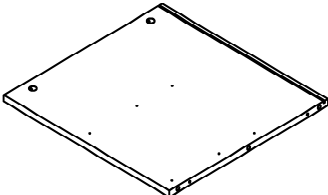
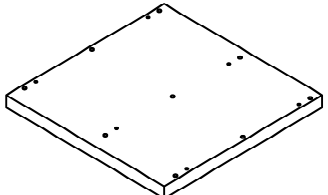
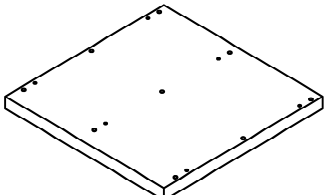
PIÈCE / PART #	IMAGE	DESCRIPTION	QTY / QTÉ
1		FRONT FACING LEFT SIDE PANEL PANNEAU DE CÔTÉ GAUCHE	1
2		FRONT FACING RIGHT SIDE PANEL PANNEAU DE CÔTÉ AVANT DROIT	1
3		DIVIDER PANEL PANNEAU DE DIVISION	1
4		BOTTOM PANEL PANNEAU DU BAS	1
5		TOP PANEL PANNEAU DE SURFACE	1

**LISTE DES PIÈCES**  
**PARTS LIST**

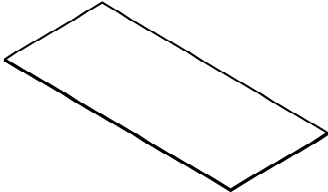
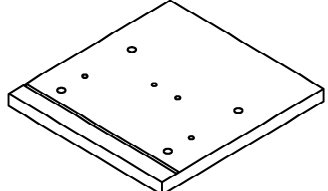
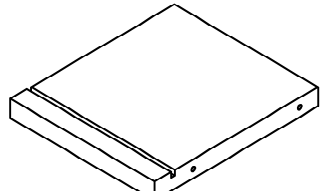
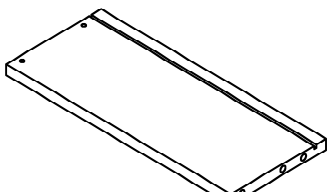
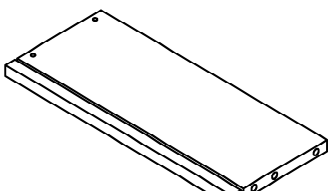
PIÈCE / PART #	IMAGE	DESCRIPTION	QTY / QTÉ
6		BACK PANEL PANNEAU ARRIÈRE	1
7		DRAWER FRONT PANEL PANNEAU AVANT TIROIR	2
8		DRAWER BACK PANEL PANNEAU ARRIÈRE TIROIR	2
9		DRAWER SIDE PANEL PANNEAU DE CÔTÉ TIROIR	2
10		DRAWER SIDE PANEL PANNEAU DE CÔTÉ TIROIR	2

**LISTE DES PIÈCES**  
**PARTS LIST**

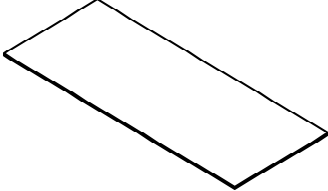
PIÈCE / PART #	IMAGE	DESCRIPTION	QTY / QTÉ
11		DRAWER BOTTOM PANEL PANNEAU DU BAS TIROIR	2

**LISTE DES PIÈCES DE MONTAGE**  
**HARDWARE LIST**

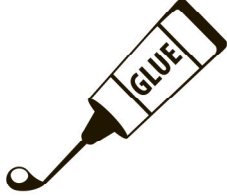
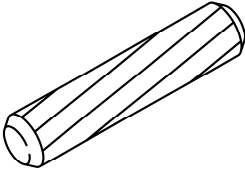
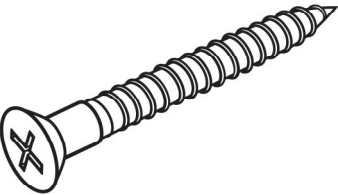
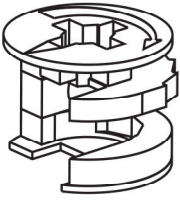
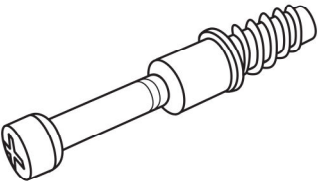
PIÈCE / PART #	IMAGE	DESCRIPTION	QTY / QTÉ
<b>A</b>		GLUE COLLE	<b>1</b>
<b>B</b>		WOOD DOWEL - Ø3/8" X 1 1/8" GOUJON DE BOIS - Ø3/8" X 1 1/8"	<b>26</b>
<b>C</b>		ASSEMBLING SCREW - 1 5/8" VIS D'ASSEMBLAGE - 1 5/8"	<b>6</b>
<b>D</b>		CAM LOCK CONNECTOR - Ø5/8" X 1/2" ÉCROU CAM LOCK - Ø5/8" X 1/2"	<b>10</b>
<b>E</b>		CAM LOCK SCREW - 1 3/8" VIS CAM LOCK - 1 3/8"	<b>10</b>

**LISTE DES PIÈCES DE MONTAGE**  
**HARDWARE LIST**

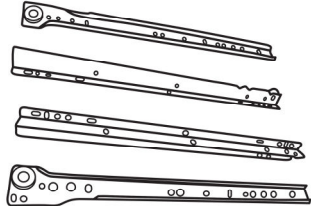
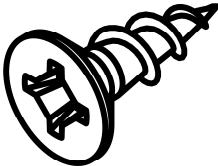
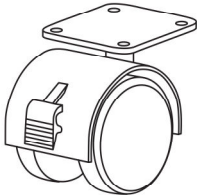
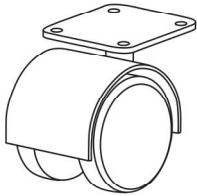
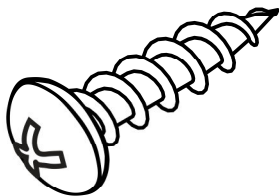
PIÈCE / PART #	IMAGE	DESCRIPTION	QTY / QTÉ
<b>F</b>		METAL DRAWER SLIDE - 13 3/4" COULISSE DE MÉTAL - 13 3/4"	2
<b>G</b>		ASSEMBLING SCREW - 1/2" VIS D'ASSEMBLAGE - 1/2"	24
<b>H</b>		WHEEL - Ø2" ROUE - Ø2"	2
<b>I</b>		WHEEL - Ø2" ROUE - Ø2"	2
<b>J</b>		ASSEMBLING SCREW - 5/8" VIS D'ASSEMBLAGE - 5/8"	16

**LISTE DES PIÈCES DE MONTAGE**  
**HARDWARE LIST**

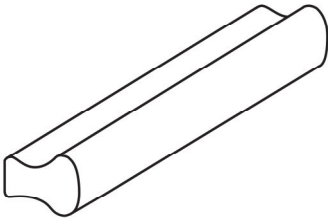
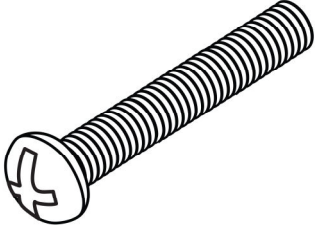
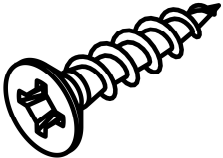
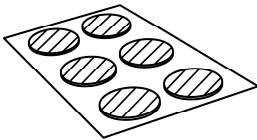
PIÈCE / PART #	IMAGE	DESCRIPTION	QTY / QTÉ
K		HANDLE - 2" POIGNÉE - 2"	2
L		ASSEMBLING BOLT - 7/8" BOULON D'ASSEMBLAGE - 7/8"	4
M		ASSEMBLING SCREW - 1 3/8" VIS D'ASSEMBLAGE - 1 3/8"	8
N		FINISHING STICKER - Ø3/4" COLLANT DE FINITION - Ø3/4"	10

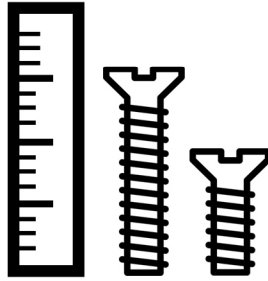

OUTIL DE VÉRIFICATION DE DIMENSIONS DES PIÈCES  
HARDWARE DIMENSIONS VERIFICATION TOOL

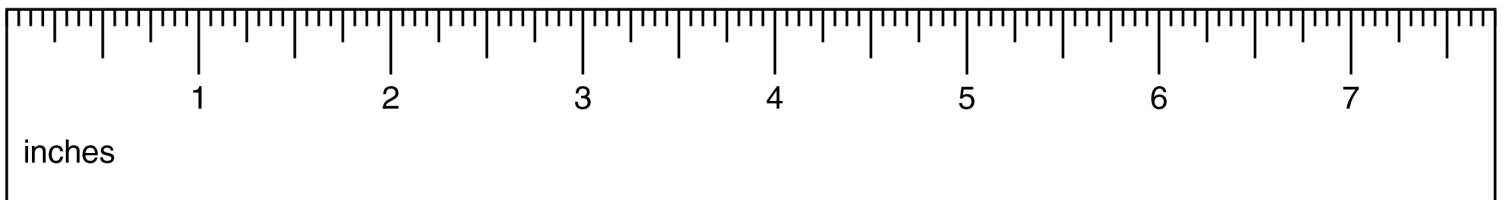



**ÉTAPE / STEP 1**

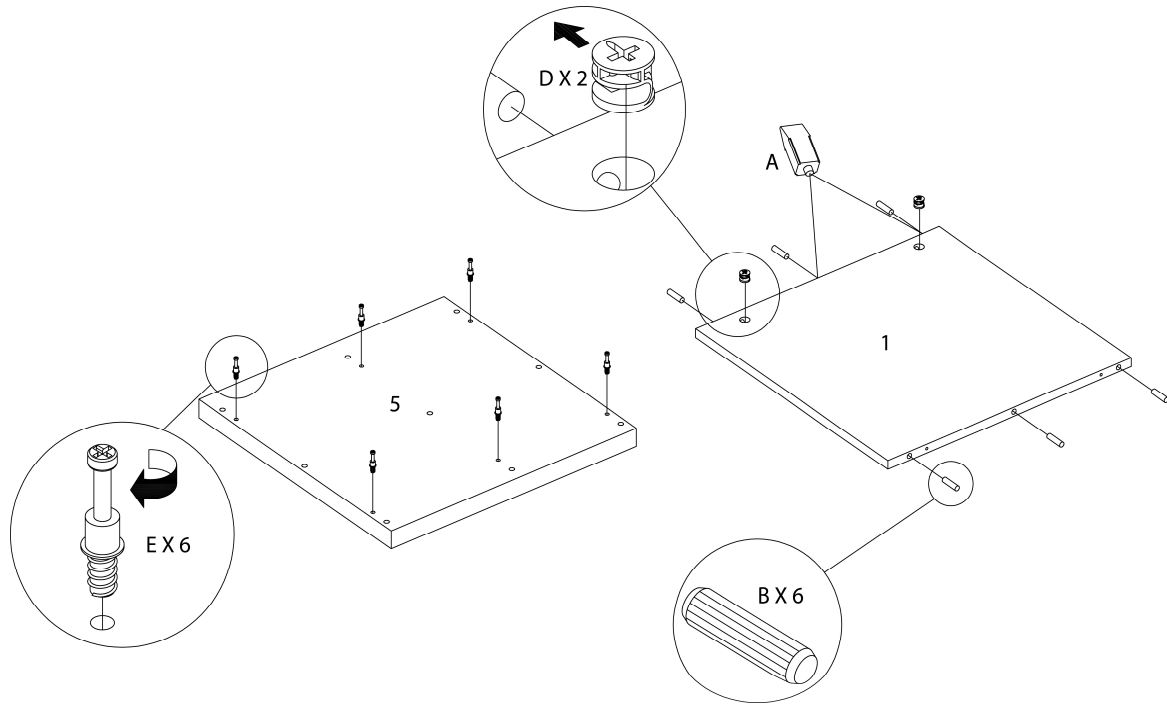

**ÉTAPE / STEP 2**

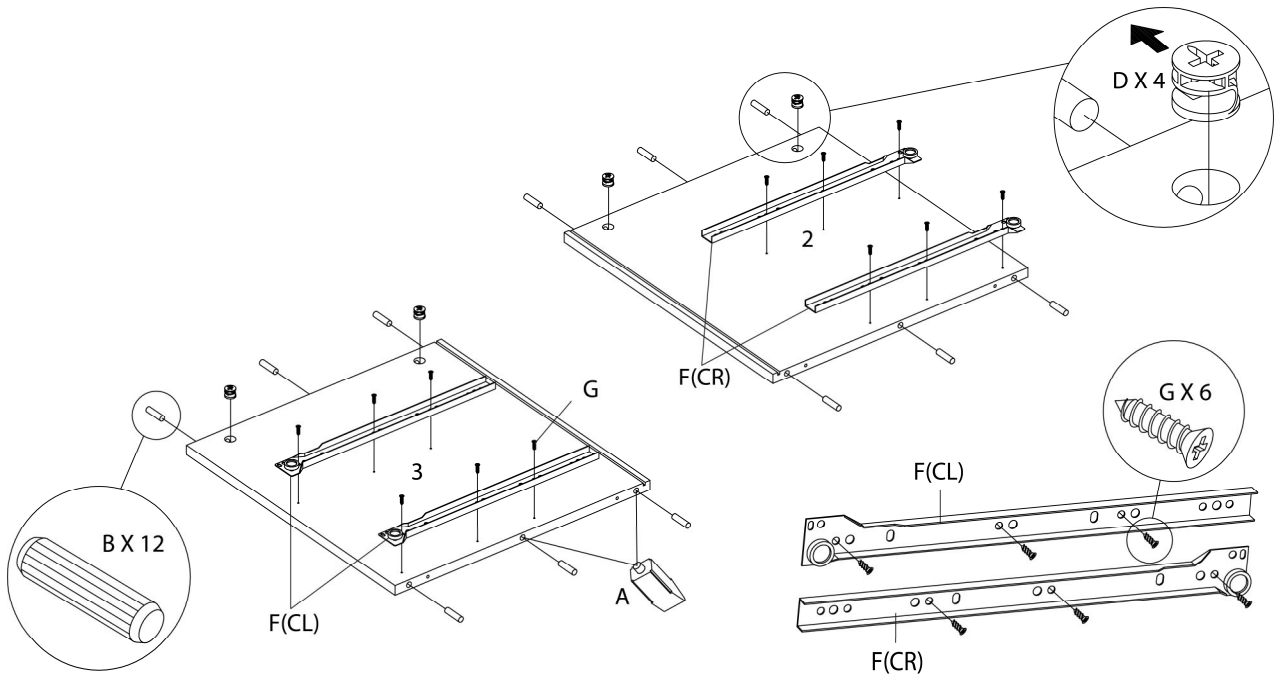

ÉTAPE / STEP 3

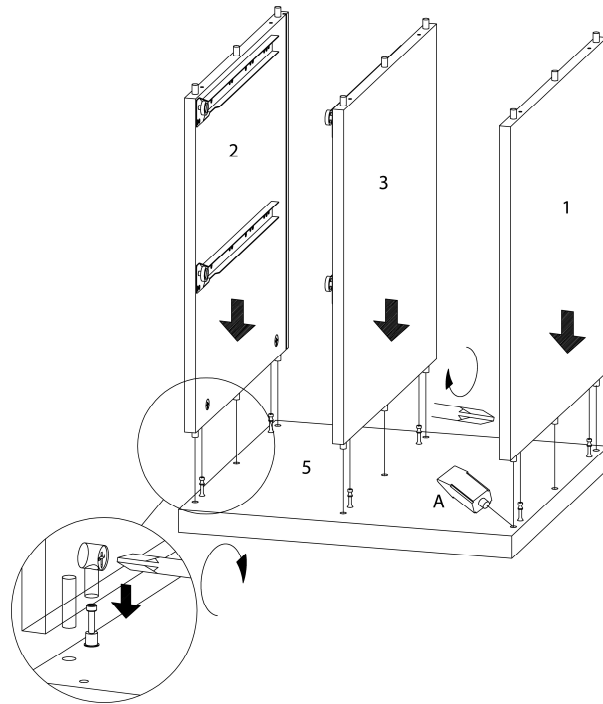

ÉTAPE / STEP 4

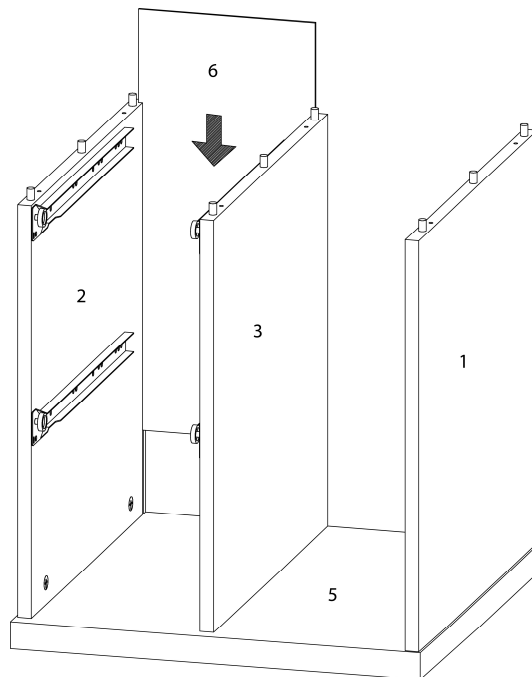

ÉTAPE / STEP 5

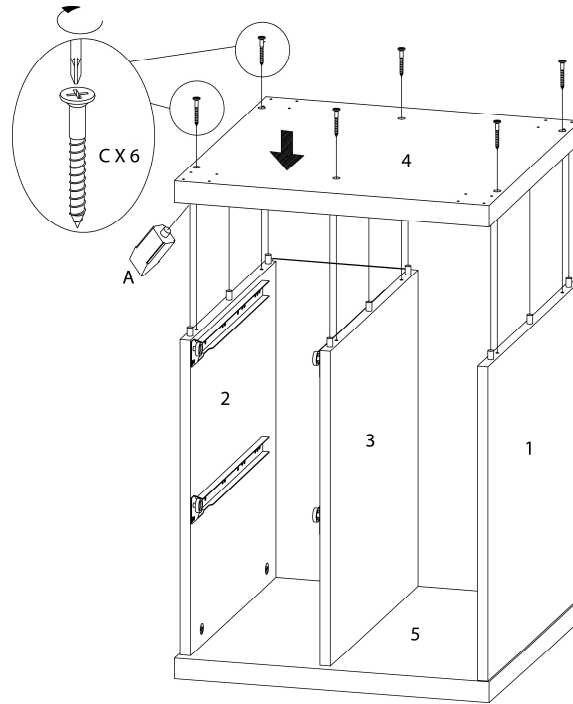

ÉTAPE / STEP 6

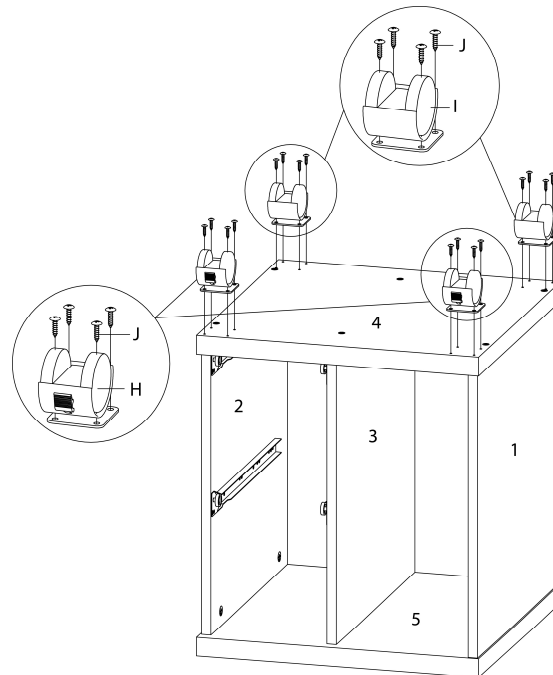

**ÉTAPE / STEP 7**

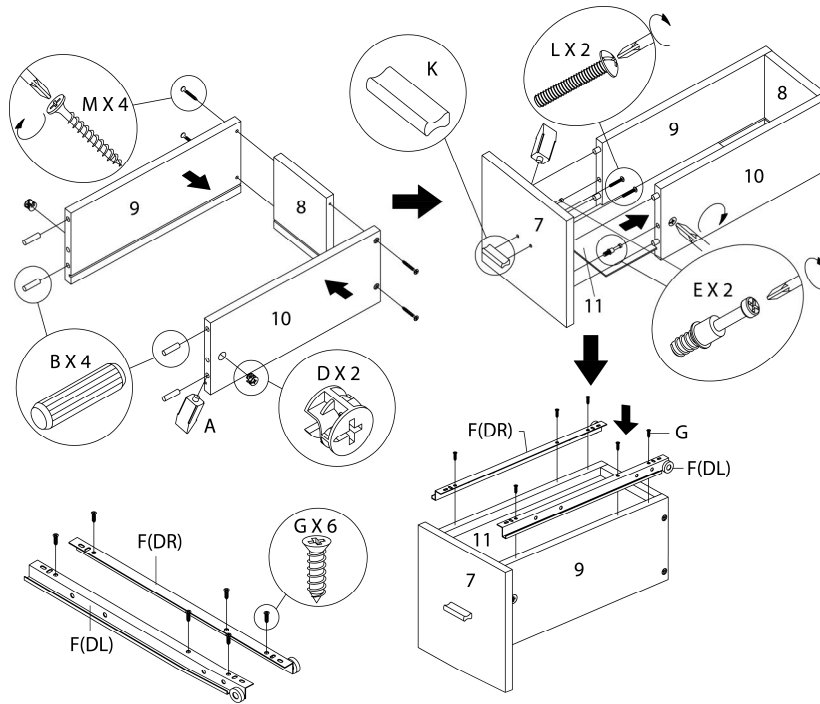

**ÉTAPE / STEP 8**

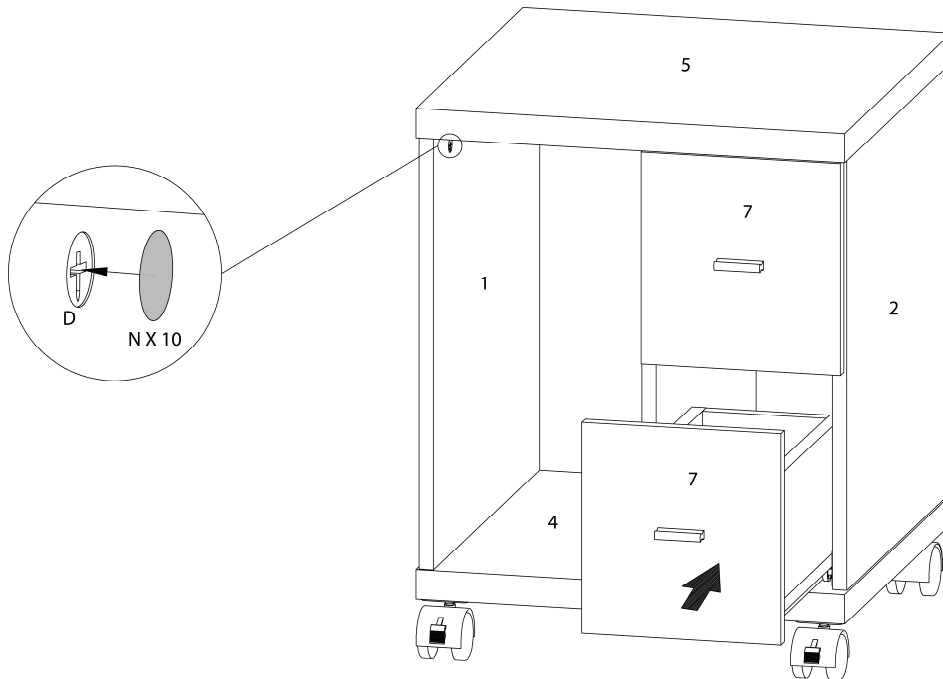

ÉTAPE / STEP 9

