

PARTS LIST / LISTE DES PIÈCES / LISTA DE PIEZAS

ITEM NO. / ARTICLE NO. / ARTICULO NO : 8808-050

DESCRIPTION / LA DESCRIPTION / DESCRIPCIÓN : NIGHTSTAND / TABLE DE CHEVET / MESA DE NOCHE

WARNING	
	Serious or fatal crushing injuries can occur from furniture tip-over. To help prevent tip-over:
	<ul style="list-style-type: none">• Install tipover restraint provided.• Place heaviest items in the lowest drawers.• Do not set TV's or other heavy objects on top of this product, unless the product is specifically designed to accommodate them.• Never allow children to climb or hang on drawers, doors, or shelves.• Never open more than one drawer at a time. <p>(OR)</p> <ul style="list-style-type: none">• Do not defeat or remove the drawer interlock system.
Use of tip-over restraints may only reduce, but not eliminate, the risk of tip-over.	
<i>This is a permanent label. Do not remove!</i>	

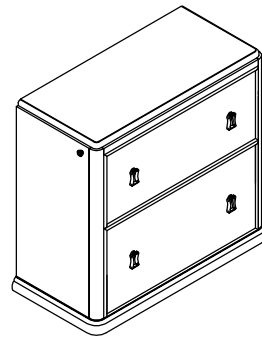
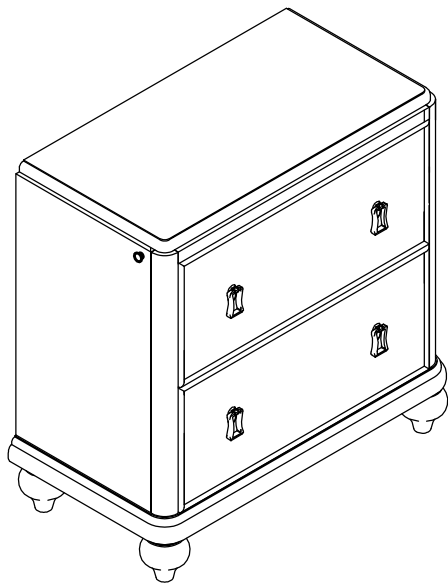

A

x1 Nightstand
x1 Table de chevet
x1 Mesa de noche

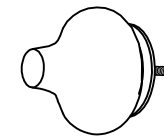

B

x4 Bun Foot *
x4 Pied en forme d'oignon
X4 Pata redonda

* Replaceable part



ASSEMBLY INSTRUCTIONS / INSTRUCTIONS D'ASSEMBLAGE / INSTRUCCIONES PARA EL ENSAMBLAJE

ITEM NO. / ARTICLE NO. / ARTICULO NO : 8808-050

DESCRIPTION / LA DESCRIPTION / DESCRIPCIÓN : NIGHTSTAND / TABLE DE CHEVET / MESA DE NOCHE

WARNING	
	Serious or fatal crushing injuries can occur from furniture tip-over. To help prevent tip-over:
	<ul style="list-style-type: none">• Install tipover restraint provided.• Place heaviest items in the lowest drawers.• Do not set TV's or other heavy objects on top of this product, unless the product is specifically designed to accommodate them.• Never allow children to climb or hang on drawers, doors, or shelves.• Never open more than one drawer at a time. <p>(OR)</p> <ul style="list-style-type: none">• Do not defeat or remove the drawer interlock system.
Use of tip-over restraints may only reduce, but not eliminate, the risk of tip-over.	
<i>This is a permanent label. Do not remove!</i>	

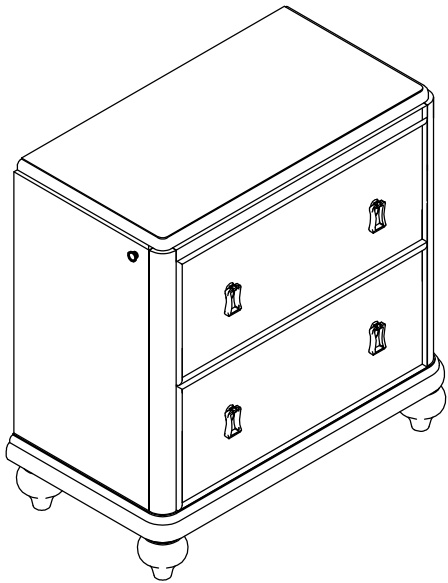

Light touch switch
Interrupteur tactile
Interruptor táctil

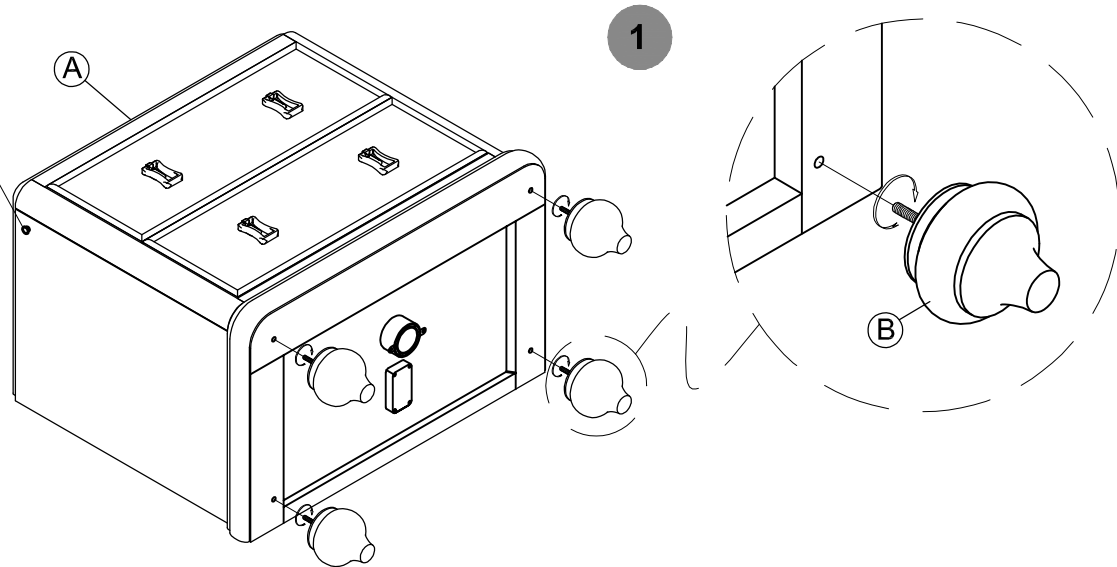

* Replaceable part



REPLACEABLE PART / PARTIE REMPLACABLE / PARTE REEMPLAZABLE

ITEM NO. / ARTICLE NO. / ARTICULO NO : 8808-050

DESCRIPTION / LA DESCRIPTION / DESCRIPCIÓN : NIGHTSTAND / TABLE DE CHEVET / MESA DE NOCHE

WARNING	
	<p>Serious or fatal crushing injuries can occur from furniture tip-over. To help prevent tip-over:</p> <ul style="list-style-type: none"> • Install tipover restraint provided. • Place heaviest items in the lowest drawers. • Do not set TV's or other heavy objects on top of this product, unless the product is specifically designed to accommodate them. • Never allow children to climb or hang on drawers, doors, or shelves. • Never open more than one drawer at a time. <p>(OR)</p> <ul style="list-style-type: none"> • Do not defeat or remove the drawer interlock system. <p>Use of tip-over restraints may only reduce, but not eliminate, the risk of tip-over.</p> <p><i>This is a permanent label. Do not remove!</i></p>

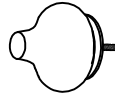

x4 R8808-010-FOOT-Bun Foot *
Pied en forme d'oignon
Pata redonda



x4 R8808-010-PULL-Common Pull *
Poignée
Tirador



x1 R8808-050-LIGHT- Light *
Lumière
Luz

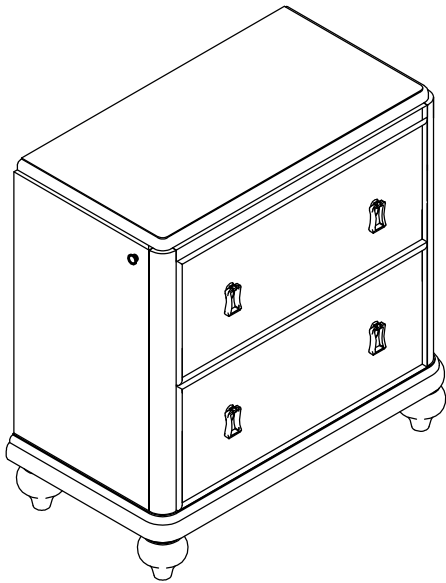

x2 RT8808-010-DR-Drawer Glide *
Glissière
Carril de deslizamiento

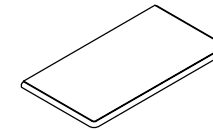

x1 R8808-050-TOP-Top *
Supérieur
Superior

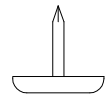

x4 RC-WH-NAIL-White Plastic Nail *
Clou
Clavo

* Replaceable part