



MAGNUSSEN®
H O M E

Bringing dreams home.

ASSEMBLY INSTRUCTIONS

MODEL : H3612-82 Desk Chair

CAUTION: PLEASE READ ALL INSTRUCTIONS BEFORE STARTING THE ASSEMBLY OF THIS PRODUCT. THESE PIECES ARE HEAVY. IN ORDER TO PREVENT PERSONAL INJURY AND ENSURE THAT THIS PRODUCT IS NOT DAMAGED DURING THE ASSEMBLY PROCESS, IT IS STRONGLY RECOMMENDED THAT YOU ENLIST THE ASSISTANCE OF ONE OR MORE PEOPLE.

ATTENTION: VEUILLEZ LIRE TOUTES LES INSTRUCTIONS AVANT DE COMMENCER L'ASSEMBLAGE DE CE PRODUIT. LES PIÈCES SONT LOURDES. POUR ÉVITER TOUTE BLESSURE ET POUR VOUS ASSURER QUE LE PRODUIT N'EST PAS ENDOMMAGÉ PENDANT L'ASSEMBLAGE, NOUS VOUS RECOMMANDONS DE FAIRE APPEL À UNE OU PLUSIEURS AUTRES PERSONNES.

CUIDADO: FAVOR DE LEER TODAS LAS INSTRUCCIONES ANTES DE ENSAMBLAR SU PRODUCTO. ESTAS PIEZAS SON PESADAS. PARA PREVENIR HERIDAS PERSONALES Y ASEGURAR QUE SU PRODUCTO NO SEA DAÑADO MIENTRAS ES ENSAMBLADO, SE RECOMIENDA LA ASISTENCIA DE UNA O MÁS PERSONAS.

WARNING.....PROTECTIVE GLIDE IS PLACED UNDER LEGS OF FURNITURE TO RESIST SCRATCHES TO FLOOR SURFACE. SOME FLOOR SURFACES CAN BE EXTRA SENSITIVE TO MARKING. IF YOU ARE NOT SURE CONSULT WITH YOUR DEALER.



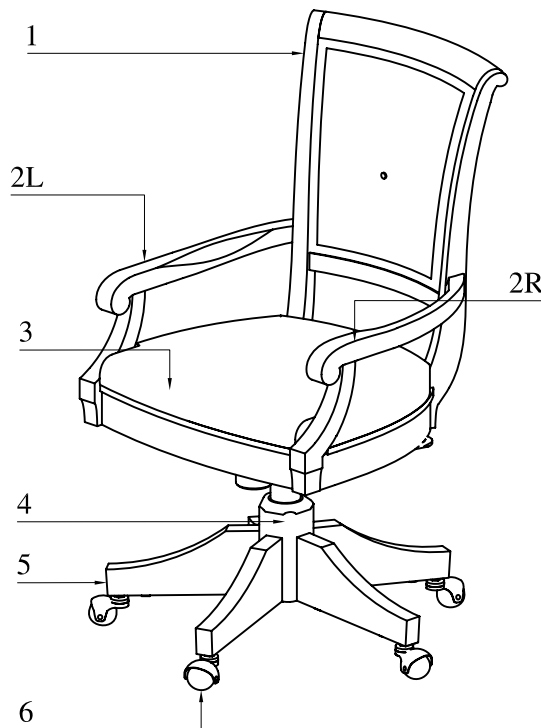









AVERTISSEMENT... LES PIEDS DES MEUBLES SONT MUNIS DE PATINS DESTINÉS À PROTÉGER LE PLANCHER. CERTAINS REVÊTEMENTS DE SOL PEUVENT ÊTRE TRÈS FRAGILES. EN CAS DE DOUTE, CONSULTER LE MARCHAND.



LIST OF PARTS AND HARDWARE

| No. | Description | Q'ty |
|-----|------------------|------|
| 1 | Chair Seat | 1 |
| 2 | Left & right arm | 2 |
| 3 | Cushion Seat | 1 |
| 4 | Wood post cover | 1 |
| 5 | Wood leg cover | 5 |
| 6 | Caster | 5 |
| 7 | Upper base | 1 |
| 8 | Cylinder | 1 |
| 9 | Bottom base | 1 |

LIST OF PARTS AND HARDWARE

| No. | Description | Q'ty |
|-----|---|-----------------|
| A |  Bolt | Φ5/16"* 45 mm 1 |
| B |  Bolt | Φ5/16"* 57 mm 4 |
| C |  Bolt | Φ5/16"* 70 mm 4 |
| D |  Bolt | Φ1/4"*38mm 2 |
| E |  Bolt | Φ1/4"* 20 mm 4 |
| F |  Flat washer | Φ9/Φ22 mm 14 |
| G |  Lock washer | Φ9/Φ11 mm 9 |
| H |  Flat washer | Φ6/Φ19 mm 4 |
| K |  Wrench | 10 mm 1 |
| L |  Wrench | 12 mm 1 |
| M |  Wrench | 17 mm 1 |
| N |  Screw | Φ3* 20 mm 10 |



MAGNUSSEN®
H O M E

Bringing dreams home.

ASSEMBLY INSTRUCTIONS

MODEL : H3612-82 Desk Chair

