









CAUTION: PLEASE READ ALL INSTRUCTIONS BEFORE STARTING THE ASSEMBLY OF THIS PRODUCT. THESE PIECES ARE HEAVY. IN ORDER TO PREVENT PERSONAL INJURY AND ENSURE THAT THIS PRODUCT IS NOT DAMAGED DURING THE ASSEMBLY PROCESS, IT IS STRONGLY RECOMMENDED TO ENLIST THE ASSISTANCE OF ONE OR MORE PERSONS. IN CASE OF EXCESS STAIN, WIPE THE BOTTOM OF THE UNIT BEFORE PLACING ON ANY SURFACE.

ATTENTION: VEUILLEZ LIRE TOUTES LES INSTRUCTIONS AVANT DE COMMENCER L'ASSEMBLAGE DE CE PRODUIT. LES PIÈCES SONT LOURDES. POUR ÉVITER TOUTE BLESSURE ET POUR VOUS ASSURER QUE LE PRODUIT N'EST PAS ENDOMMAGÉ PENDANT L'ASSEMBLAGE, NOUS VOUS RECOMMANDONS DE FAIRE APPEL À UNE OU PLUSIEURS AUTRES PERSONNES. EN CAS DE TACHE EXCESSIVE, ESSUYEZ LE FOND DE L'UNITÉ AVANT LE PLACEMENT SUR N'IMPORTE QUELLE SURFACE.



CUIDADO: FAVOR DE LEER TODAS LAS INSTRUCCIONES ANTES DE ENSAMBLAR SU PRODUCTO, ESTAS PIEZAS SON PESADAS. PARA PREVENIR HERIDAS PERSONALES Y ASEGURAR QUE SU PRODUCTO NO SEA DAÑADO MIENTRAS ES ENSAMBLADO. SE RECOMIENDA LA ASISTENCIA DE UNA O MÁS PERSONAS.

WARNING: PROTECTIVE GLIDE IS PLACED UNDER EACH LEG OF THE FURNITURE TO RESIST SCRATCHES ON FLOOR SURFACE. SOME FLOOR SURFACES CAN BE EXTRA SENSITIVE TO SCRATCHES AND MARKINGS, IF YOU ARE NOT SURE CONSULT WITH YOUR DEALER. AVERTISSEMENT. LES PIEDS DES MEUBLES SONT MUNIS DE PATINS DESTINÉS À PROTÉGER LE PLANCHER. CERTAINS REVÊTEMENTS DE SOL PEUVENT ÊTRE TRÈS FRAGILES. EN CAS DE DOUTE CONSULTER LE MARCHAND.

LIST OF PARTS AND HARDWARE/ LISTE DES PIÈCES ET DU MATÉRIEL/ LISTA DE PIEZAS Y HARDWARE

No#/ NOMBRE/ NÚMERO	DESCRIPTION/ DESCRIPTION/ DESCRIPCIÓN		QUANTITY/ QUANTITÉ/ CANTIDAD
A	Flat washer/ Rondelle plate/ Arandela plana	Ø1/4"x16x2mm	 12PCS
B	Lock washer/ Rondelle de blocage/ Arandela de bloqueo	Ø1/4"x10x2mm	 12PCS
C	Bolt/ Boulon/ tornillo	Ø1/4"-x1-1/2"L	 12PCS
D	Wrench / Clé/ Llave inglesa	10mm	 1PC
E	Nut/ Écrou/ Nuez	Ø3/4"x29x15mm	 2PCS
F	Flat washer/ Rondelle plate/ Arandela plana	Ø34*2mm	 6PCS
G	Male stretcher		 1PC
H	Female stretcher		 1PC

LIST OF PARTS AND HARDWARE/ LISTE DES PIÈCES ET DU MATÉRIEL/ LISTA DE PIEZAS Y HARDWARE

No#/ NOMBRE/ NÚMERO	DESCRIPTION/ DESCRIPTION/ DESCRIPCIÓN		QUANTITY/ QUANTITÉ/ CANTIDAD
1	PT4646-86TP Table Top / Dessus de table / mesa		1PC
2	PT4646-86LF Table Leg Frame / Cadre de patte de table / Marco de la pata de la tabla		3PCS

NOTE:
ASSEMBLE UNIT ON A SOFT SURFACE.
ASSEMBLEZ L'UNITÉ SUR UNE SURFACE MOLLE.
ENSAMBLE LA UNIDAD EN UNA SUPERFICIE PLANA Y SUAVE.

DO NOT TIGHTEN BOLTS UNTIL THE UNIT IS COMPLETELY ASSEMBLED.
NE SERREZ PAS LES BOULONS JUSQU'À CE QUE L'UNITÉ SOIT COMPLÈTEMENT ASSEMBLÉE.
NO APRIETE LOS TORNILLOS HASTA QUE LA UNIDAD ESTE COMPLETAMENTE ENSAMBLADA.



MAGNUSSEN[®]
HOME

ASSEMBLY INSTRUCTIONS
INSTRUCTIONS DE MONTAGE
INSTRUCCIONES DE MONTAJE

MODEL/ MODÈLE/ MODELO: T4646-86 CONSOLE SOFA TABLE

Step/ Étape/ Paso 1

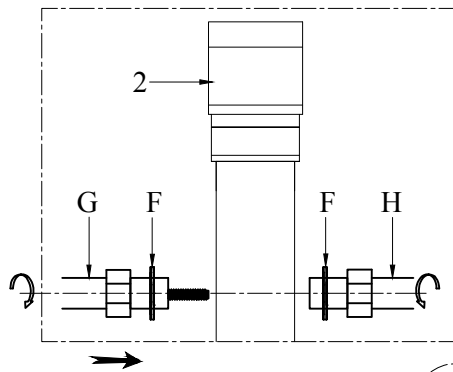

Step/ Étape/ Paso 3

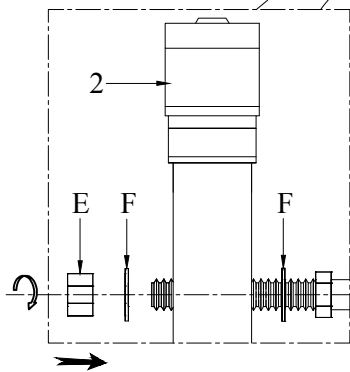
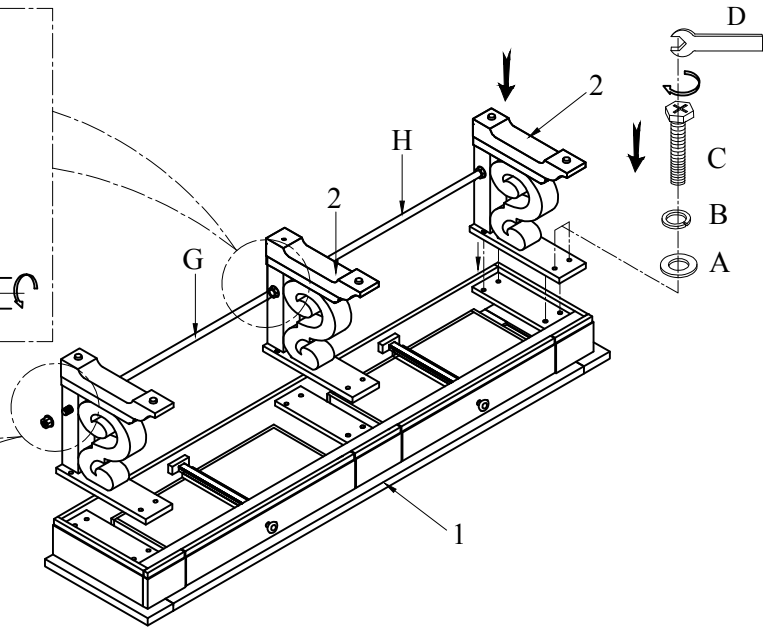

Step/ Étape/ Paso 2

