

ASSEMBLY INSTRUCTIONS /
INSTRUCTIONS D'ASSEMBLAGE

ITEM NO/NO ARTICLE:MELOBPR/223114P
MELODPR/223115P

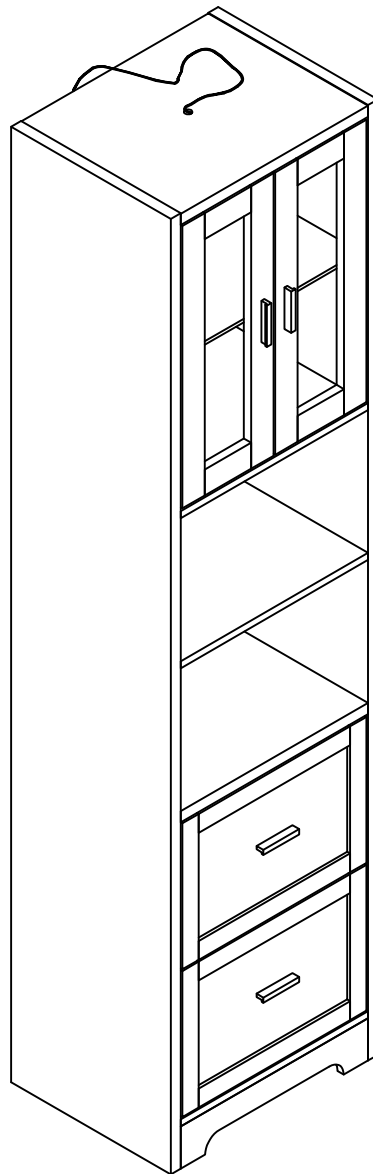

PARTS IDENTIFICATIONS / IDENTIFICATION DES PIÈCES

ITEM NO/NO ARTICLE:MELOBPR/223114P
MELODPR/223115P

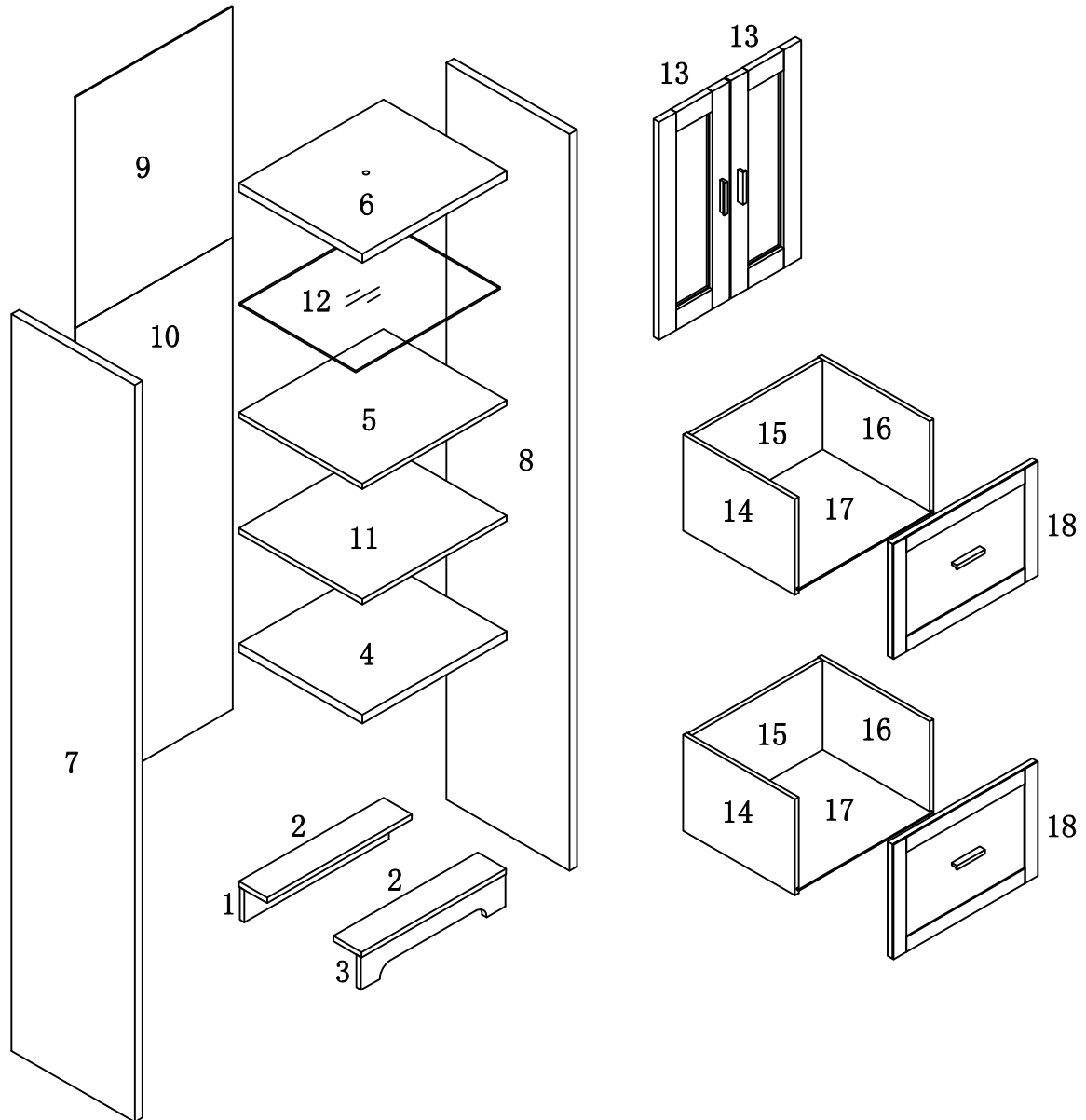



















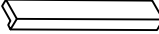



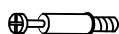

(1) 1pc/pce	(8) 1pc/pce	(15) 1pcs/pces
(2) 1pcs/pces	(9) 1pc/pce	(16) 1pcs/pces
(3) 1pc/pce	(10) 1pc/pce	(17) 1pcs/pces
(4) 1pc/pce	(11) 1pc/pce	(18) 1pcs/pces
(5) 1pc/pce	(12) 1pc/pce	
(6) 2pc/pce	(13) 2pcs/pces	
(7) 1pc/pce	(14) 2pcs/pces	

HARDWARE IDENTIFICATIONS/ IDENTIFICATION DU KIT D'ASSEMBLAGE

ITEM NO/NO ARTICLE: MELOBPR/223114P

MELODPR/223115P

A		L29	30pcs/pces
B		Φ 15	30pcs/pces
C		Φ 8x25	10pcs/pces
D		Φ 4x14	4pcs/pces
E		Φ 60	1pc/pce
F			1pc/pce
G			40pcs/pces
H			4pcs/pces
I		Φ 5x15	4pcs/pces
J		Φ 4 x 16	24pcs/pces
K		301C	4pcs/pces
L		64#	4pcs/pces
M		Φ 4x20	8pcs/pces
N		Φ 4x30	8pcs/pces
O		Φ 6x30	8pcs/pces
P		L20	8pcs/pces
Q		Φ 12	8pcs/pces
R		Φ 16	4pcs/pces
S		Φ 22	2pcs/pces
T		Φ 15	8pcs/pces
U		Φ 8x40	1pc/pce
V		Φ 12x12x1	2pcs/pces
W		Φ 5x40	1pc/pce
X		Φ 4x25	1pc/pce
Y		197×5×1	1pc/pce

ITEM NO/NO ARTICLE: MELOBPR/223114P
MELODPR/223115P

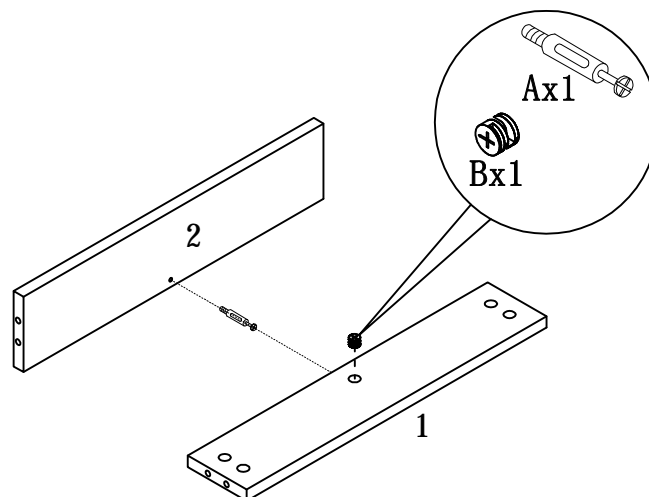

STEP 1 / ETAPE 1

STEP 2 / ETAPE 2

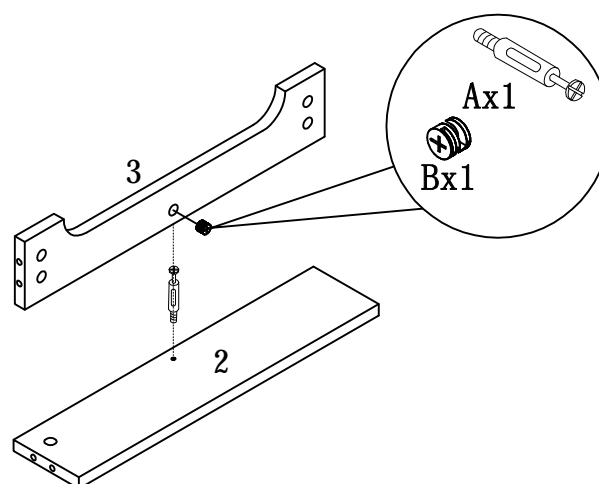

ITEM NO/NO ARTICLE: MELOBPR/223114P
MELODPR/223115P

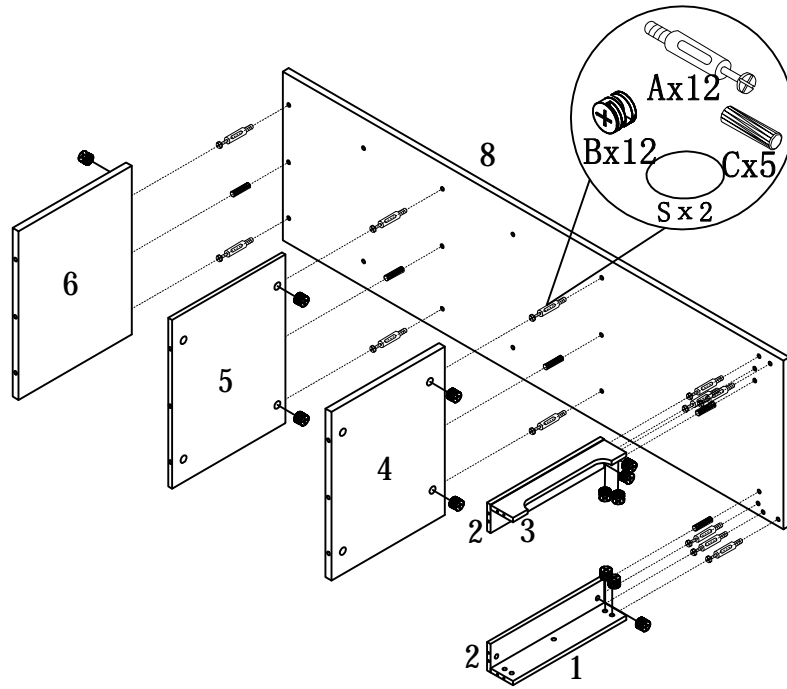

STEP 3 / ETAPE 3

STEP 4 / ETAPE 4

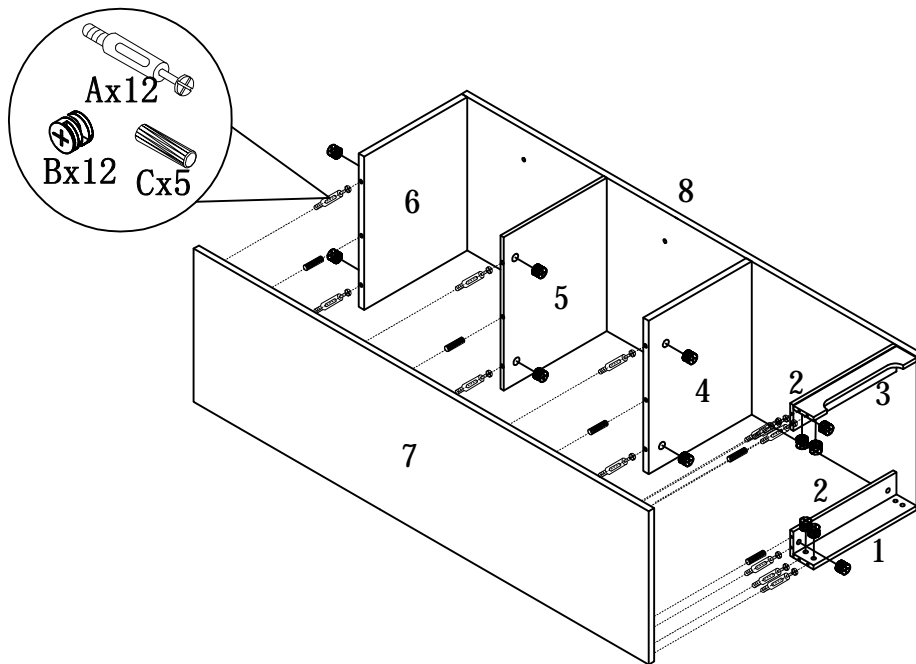

ITEM NO/NO ARTICLE:MELOBPR/223114P
MELODPR/223115P

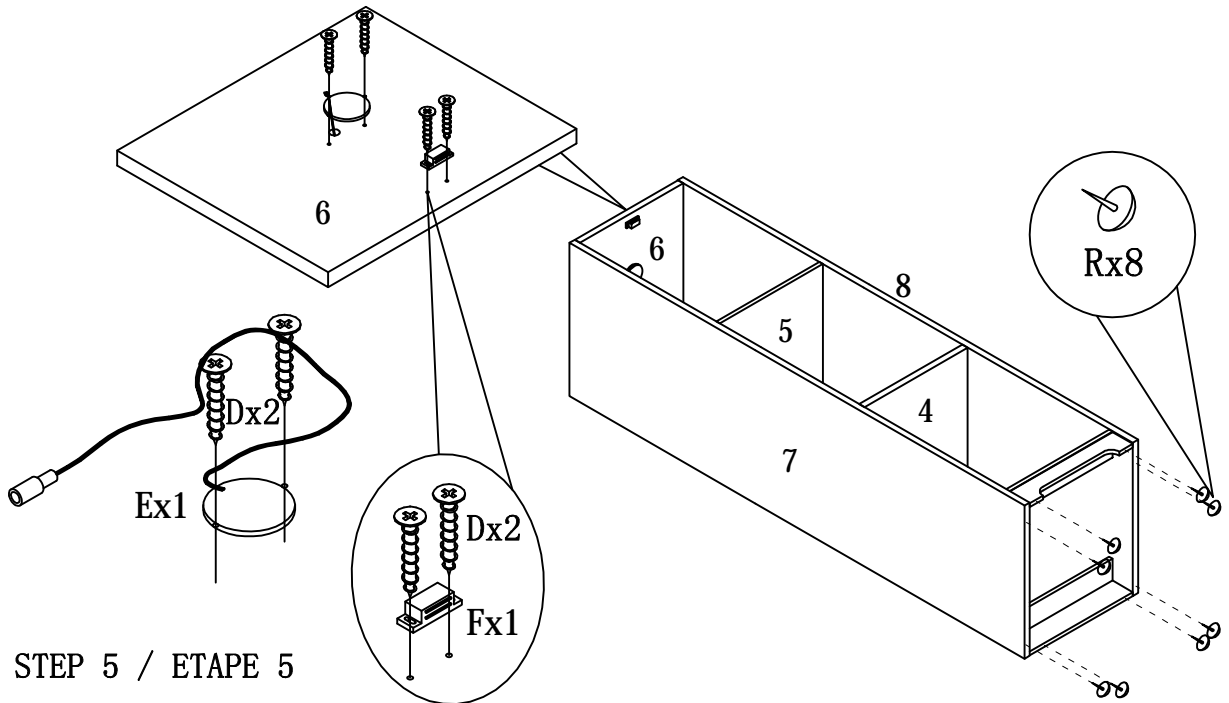

STEP 5 / ETAPE 5

STEP 6 / ETAPE 6

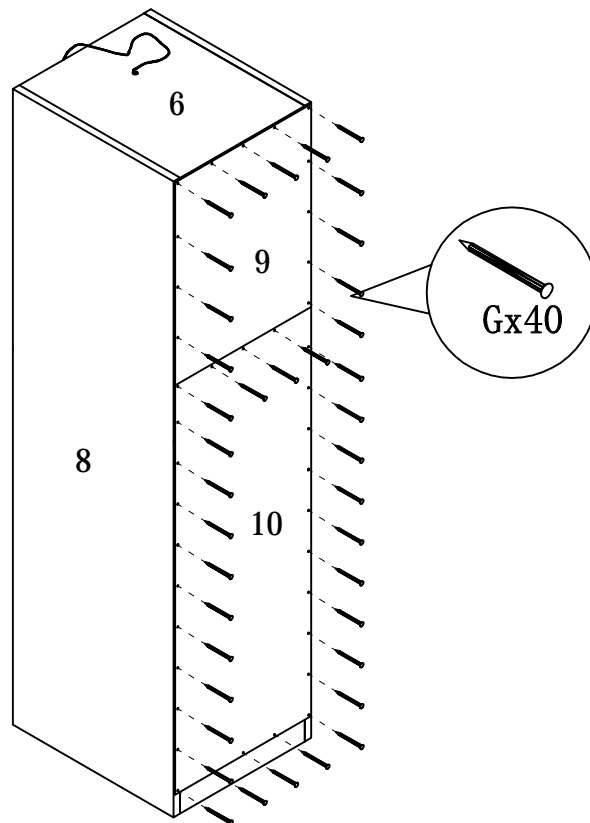

ITEM NO/NO ARTICLE:MELOBPR/223114P
MELODPR/223115P

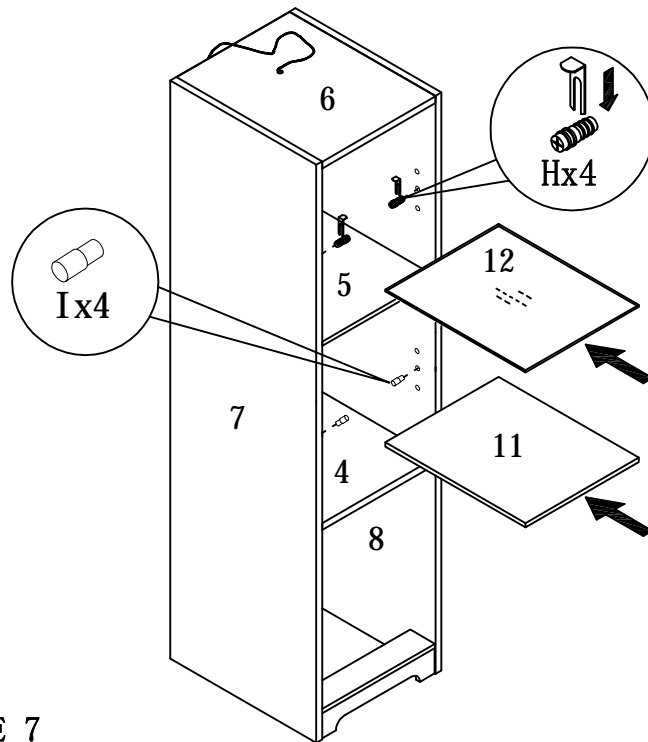

STEP 7 / ETAPE 7

STEP 8 / ETAPE 8

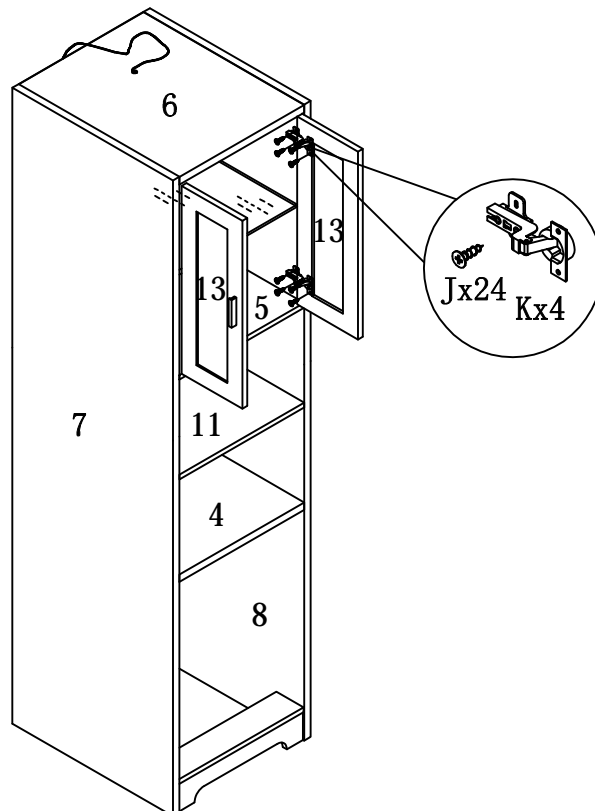

ITEM NO/NO ARTICLE:MELOBPR/223114P
MELODPR/223115P

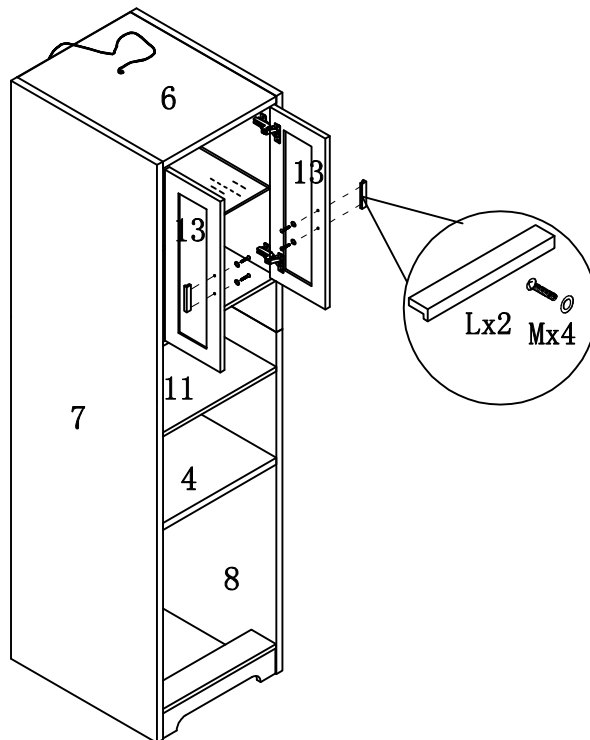

STEP 9 / ETAPE 9

STEP 10 / ETAPE 10

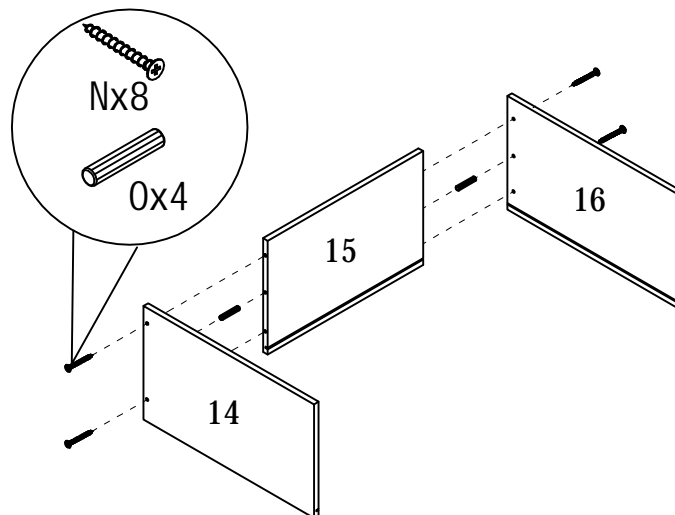

ITEM NO/NO ARTICLE:MELOBPR/223114P
MELODPR/223115P

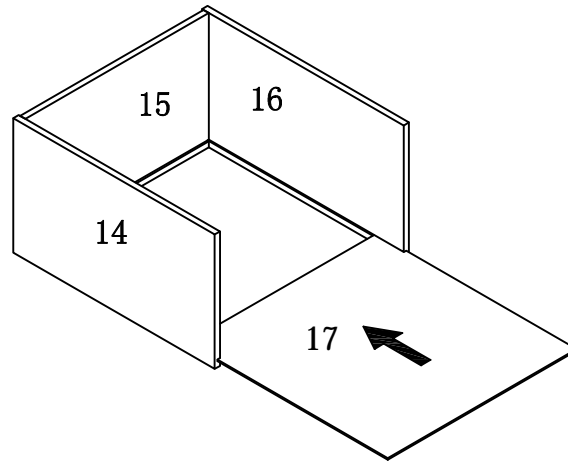

STEP 11 / ETAPE 11

STEP 12 / ETAPE 12

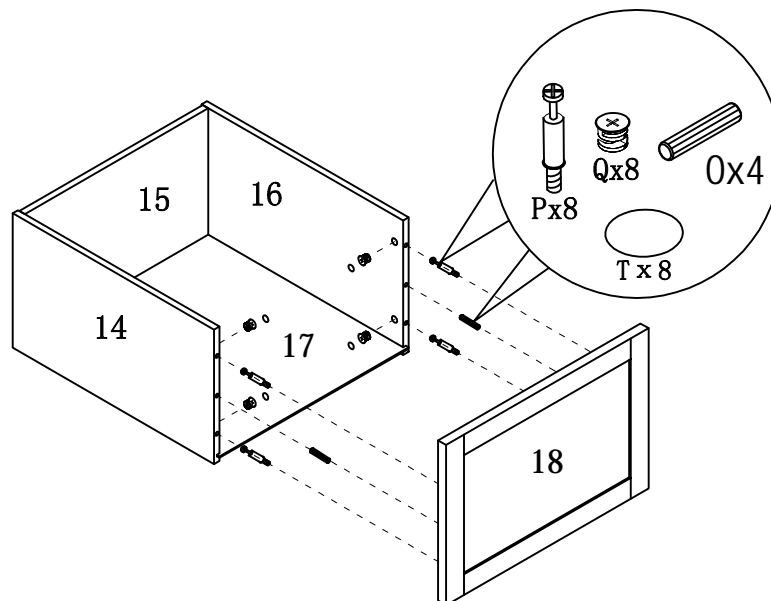

ITEM NO/NO ARTICLE:MELOBPR/223114P

MELODPR/223115P

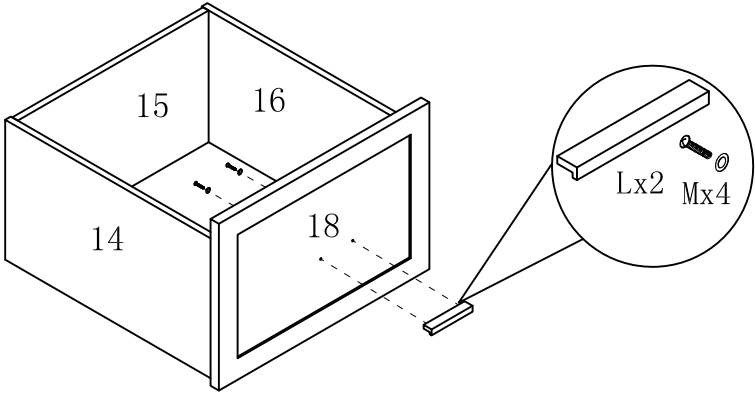

X2

STEP 13 / ETAPE 13

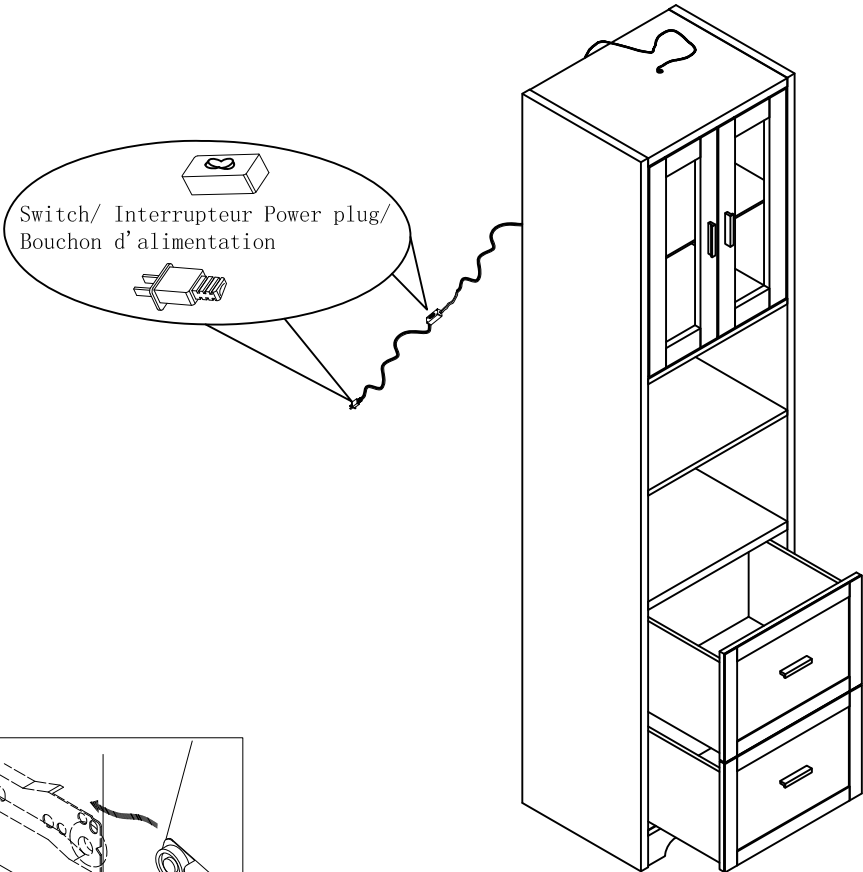

STEP 14 / ETAPE 14



ANTI-TIPPING STRAP INSTRUCTION

Instructions pour sangle anti-basculement

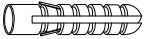
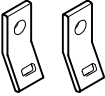
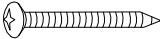
Quincaillerie (Incluse):

-  DRYWALL ANCHOR $\phi 8 \times 40$ X 1PCS
-  Fixation en métal $12 \times 12 \times 1$ X 2PCS
-  Vis $\phi 5 \times 40$ X 1PCS
-  Sangle $197 \times 5 \times 1$ X 1PCS
-  Vis $\phi 4 \times 25$ X 1PCS

Outils requis (Non inclus):

-  DRILL & DRILL BIT
Perceuse et trépan
-  LIGHT HAMMER
Marteau léger

Note: Hardware included only compatible with standard drywalls. :Notez que la quincaillerie incluse est compatible avec les ancrages de mur standard

Step 1 Étape 1

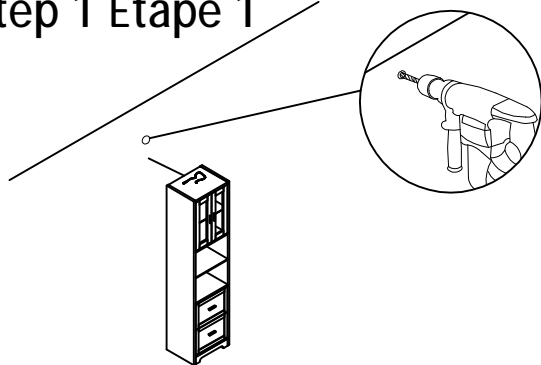

1. Find spot on wall 1" below the top of item.
Placer sur le mur à 1 pouce au-dessus de l'article.
2. Using a drill bit slightly smaller than the gauge of anchor, drill a hole, then place the anchor into wall.
À l'aide d'un trépan légèrement plus petit qu'un ancrage en acier de jauge, percer un trou puis placer l'ancrage dans le mur.

Step 2 Étape 2

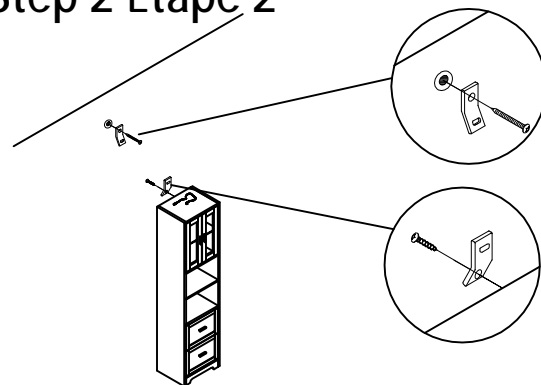

1. Screw the metal bracket into the anchor of wall.
Visser la première fixation en métal à l'intérieur de l'ancrage de mur.
2. Screw the second metal bracket into the back of item along the of soleid frame.
Visser la deuxième fixation à l'arrière de l'article.

Step 3 Étape 3

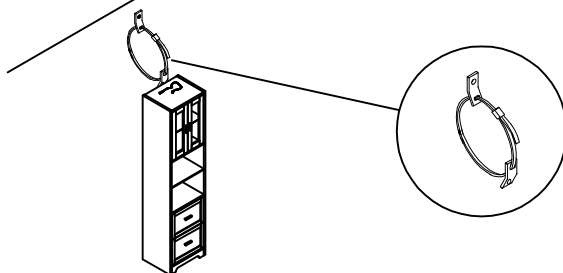

1. Insert strap thru the bracket attached to wall and the second attached to the product.
Insérer la sangle à l'intérieur de la fixation en métal. Elle s'attache facilement sur l'arrière du meuble, l'autre bout étant fixé au mur.
2. Pull tightly: Et puis tirer fermement.