

Assemble Instruction

SKU# ARIELBNC ITEM#19763





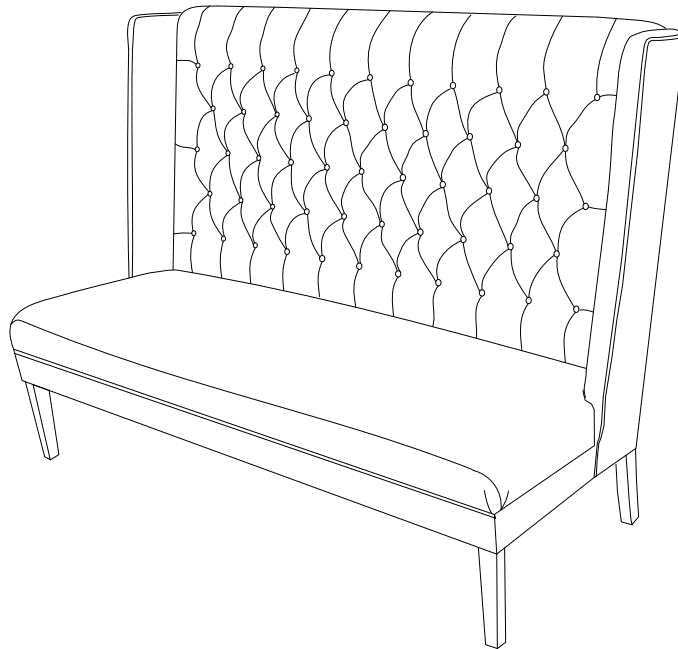

DESC.: ARIEL ENTRY BENCH - 54"

Instructions d'assemblage

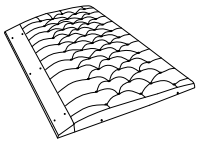
SKU# ARIELBNC ITEM#19763

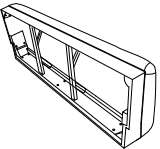
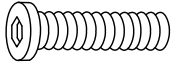
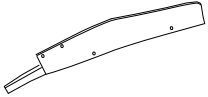
DESC.: BANC D'ENTRÉE ARIEL DE 54 PO

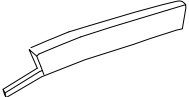

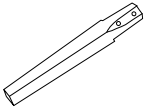
PART	DESC	QTY	PART	DESC	QTY
 A	Back Retour	1pc	 F	Allen Key 5M Clé hexagonale	1pc
 B	Seat Places assises	1pc	 G	Bolt Ø5/16"×1.75" Boulon	15PCS
 C	Left Arm Bras gauche	1pc	 H	Spring Washer 5/16" Rondelle frein	15PCS
 D	Right Arm Bras droit	1pc	 I	Flat Washer 5/16" Rondelle plate	15PCS
 E	Leg Les jambes	2PCS			

Step/Étape 1

Always assembly products on a smooth flat and clean surface
/Toujours assembler les produits sur une surface lisse et propre.

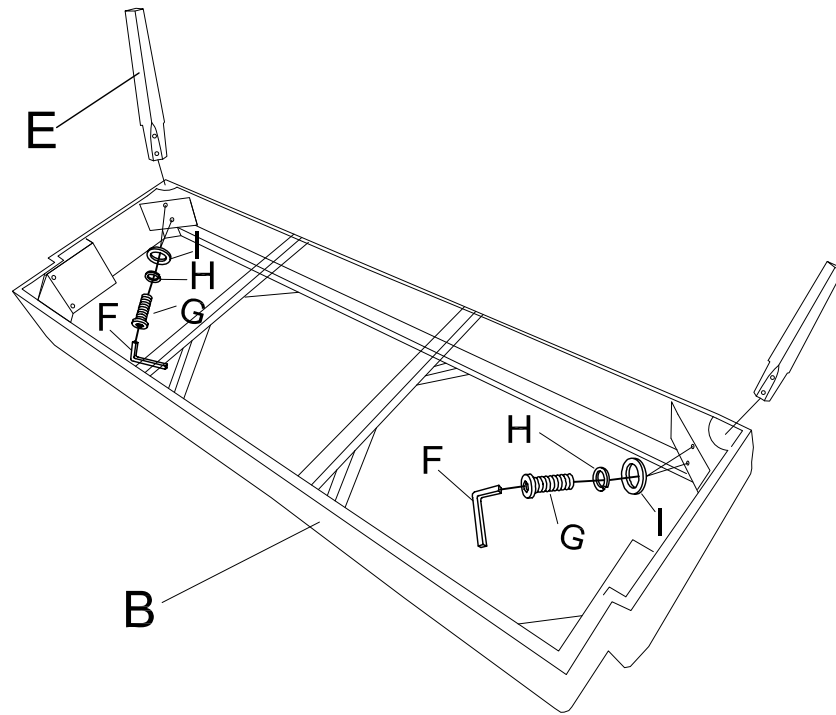

Step/Étape 2

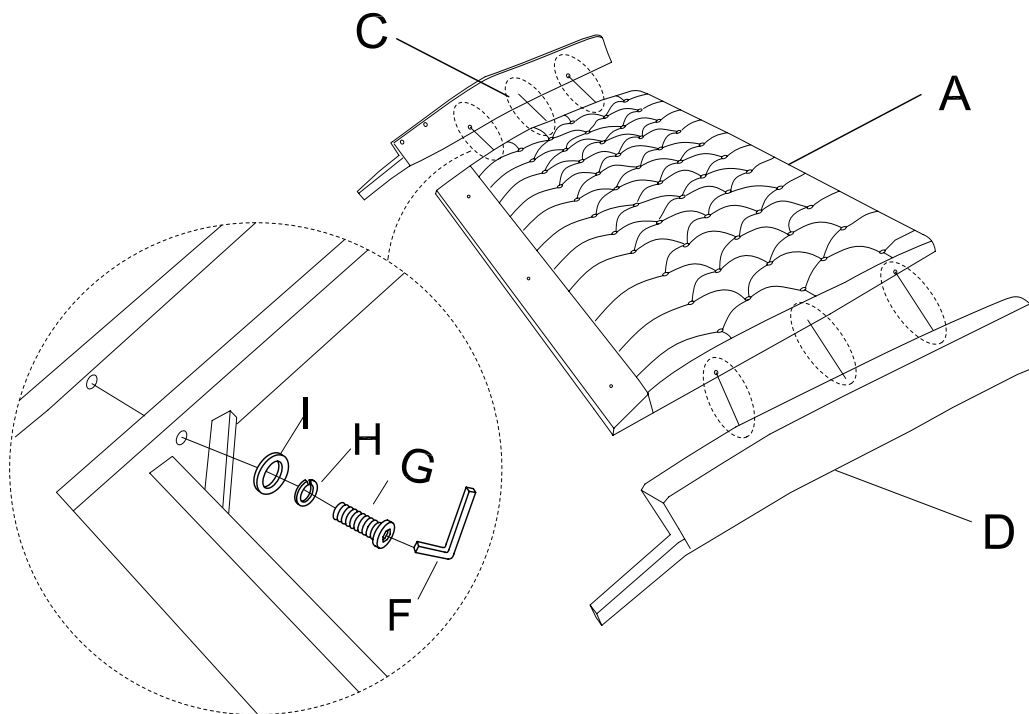

Step/Étape 3

