



SLEEP SYSTEMS
OWNER'S MANUAL
SPIRIT

Model SF03M5W-3+4+6
SFN03M5WEK-3+4+6



The logo for INNOVA SLEEP SYSTEMS features the word "INNOVA" in a blue, sans-serif font. A green and blue wave-like graphic element is positioned behind the letters "NOVA". Below "INNOVA" is a thin blue horizontal line, and underneath that is the text "SLEEP SYSTEMS" in a black, sans-serif font.

INNOVA
SLEEP SYSTEMS

Table of Contents

Precautions	3
Parts List	6
Installation Guide	7
Remote Control Instructions	14
Warranty Info.....	19

PRECAUTIONS

WARNING

Read the following information before using this product. Failure to adhere to these terms and precautions could compromise safety, cause product malfunction and/or void a portion of your warranty.

Electrical power surges are a leading cause of problems with electrical circuits. In order to help protect your investment in case of a power surge or outage, use an electrical surge protection device (not included).

WARRANTY WARNING!

Do not open or tamper with the transformer, control box, motors, or remote control (with the exception of opening battery compartments as necessary). Your product warranty will be void if these components are tampered with.

Do not remove the law label attached to the base of this product. Removing the law label may delay the processing, or void all or a portion, of your warranty claim.

SMALL CHILDREN AND PETS:

Immediately dispose of all packing materials as they can smother, choke, or otherwise harm small children and pets. Do not allow any person or pets under the bed. Children, convalescents, and disabled persons should not operate the bed without adult supervision.

HOSPITAL OR CONVALESCENT USE DISCLAIMER:

This adjustable base is designed and engineered for a lifestyle of in-home comfort and not intended for hospital use, for a bed-ridden persons, or for an extended recovery. This product is not equipped with bars to help persons get safely in and out of bed and is not intended for use around tent type oxygen therapy or explosive gases.

PRODUCT RATINGS:

The product's lift motors are not designed for continuous use of more than 2 minutes in an 18 minute period, or approximately 10% duty cycle. For every 30 minutes of use for the massage motor, 30 minutes of rest is needed. The massage functions should be used for a total of 2 hrs in a 12 hr period. Any attempt to circumvent or exceed this rating will shorten the life expectancy of the product and may void the warranty.

WEIGHT LIMITS:

The limitation for this product is 750 lbs. This product will structurally support up to 750 lbs, provided the mattress is evenly distributed across the product and the weight isn't concentrated in one area. This product is not designed to support or lift such amounts in the head or foot section alone. Exceeding this weight restriction will void the warranty and could damage the bed and/or cause injury. Enter and exit the bed in a flat position and do not sit on the head or foot sections while this product is in the raised position.

ELECTRONIC MECHANISMS:

It is normal for the raising and lowering feature of this product to emit a minimal humming sound during operation. The massage feature creates a vibrating hum during operation and the resonance will increase accordingly with a higher intensity motor setting.

LOCATION ENVIRONMENT:

The level of sound experienced in a room is directly related to the environment within that location. In a room with hardwood floors and the massager turned on, a vibrating noise may be noticeable. Placing a piece of carpet or rubber casters cups under the legs of the product may reduce this resonance. The rubber caster cups also prevent the product from sliding when located on smooth or hard surface flooring.

TO REDUCE THE RISK OF SHOCK, BURNS, FIRE OR INJURY:

Make sure the product is in the flat position before unplugging from power source. Always unplug the product from the electrical outlet before cleaning or servicing the product. If the cord or plug is damaged, document the damage and contact customer service for advisement on continued use.

MINIMUM LEG HEIGHT: The minimum leg height is 4". Using this product without legs or with legs shorter than 4" will void the warranty.

MANUAL VERSION: 23041001

FCC COMPLIANCE:

This device complies with part 15 of the FCC Rules for residential use. Operation is subject to the following two conditions: (1) This device may not cause harmful interference, and (2) this device must accept any interference received, including interference that may cause undesired operation.

Radio Frequency: 2.4 GHz

EMERGENCY BATTERY BACKUP (OPTIONAL ADD-ON):

In the event that the product is stuck in an articulated position during a power outage, the battery backup in the transformer will return the product to the flat position. To do this, install two new 9-volt alkaline batteries into the battery compartment of the transformer. Use the reset button on the control box to return the base to the flat position. Remove batteries after lowering.



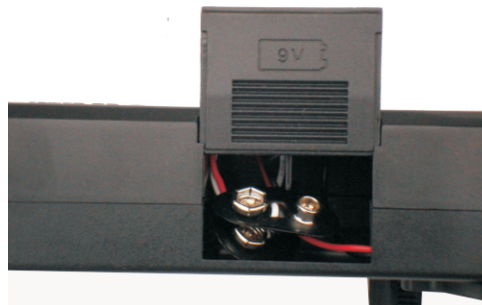



Batteries should not be used for normal operation of the product.



PARTS LIST

Step 1:

Check and verify all parts are included before discarding any packing materials. All electronics and components that need to be installed are located in boxes under the base or attached to the frame (* indicating that the parts attached to the base) .

 <p>A) Wireless Remote Control (1)</p>	 <p>B) Mattress Retainer Bar (1) Mattress Retainer Bar (2) for KING size bases</p>	 <p>C) Power Cord (1)</p>
 <p>D) Transformer (1)</p>	 <p>E) Control Box *(1)</p>	 <p>F) Legs (6) Legs (7) for KING size bases</p>

Important: We strongly recommend two able-bodied adults setup and assemble this product.

SET UP & INSTALLATION

Step 2:

With two able-bodied people, place carton on floor and remove the carton.



Step 3:

It is recommended to test the bed while still in the box before fully setting up.

- Connect the Transformer “D” to Control Box “E”. Extend the cord from Control Box “E” and attach to the short electrical output cord on Transformer “D”.
- Extend the Power Cord “C” and plug it into the Transformer “D”. (See Figure 1)

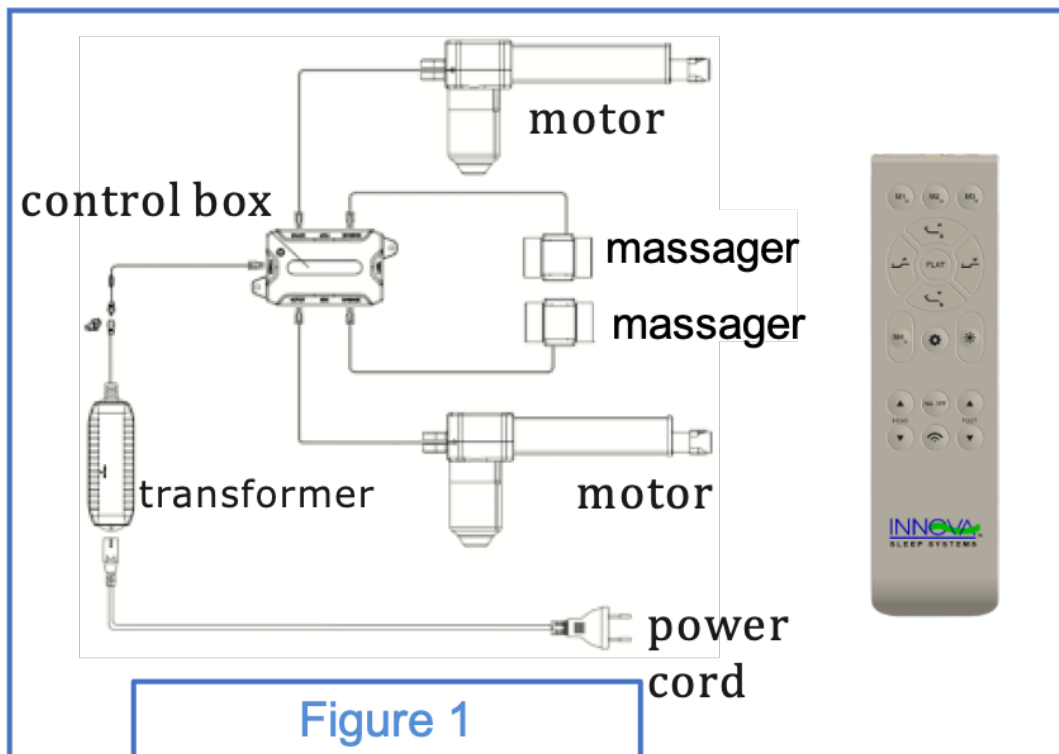

Step 4:

Insert 3 AAA batteries into the Wireless Remote.

Step 5:

Plug the Power Cord into a grounded electrical outlet. A surge protector is recommended.

Using the Wireless Remote Control, push the HEAD UP button and then push the FOOT UP button to test the bed. If the motors are working, skip to step 7.

NOTE: The actuator is a gravity down motor, which needs weight to be lowered.

Step 6:

Synchronize the Wireless Remote with the Control Box:

After plugging in the base to a grounded outlet, the base will return to a flat position and you will hear a beep. At this time, it enters the syncing state for ten seconds. (If you have not completed syncing within ten seconds, press the orange SYNC button for 2-3 seconds and release. You should hear a beep before proceeding).

Then press HEAD UP and HEAD DOWN buttons simultaneously for 3-5 seconds while the control box lights are still flashing (See Figure 2). You will hear another beep and remote lights will flash blue when syncing is successful.

The adjustable bed should work after syncing the Wireless Remote with the Control Box. Press the HEAD UP button and then FOOT UP buttons to test.

If syncing is not successful or you need to sync again, repeat the above steps.

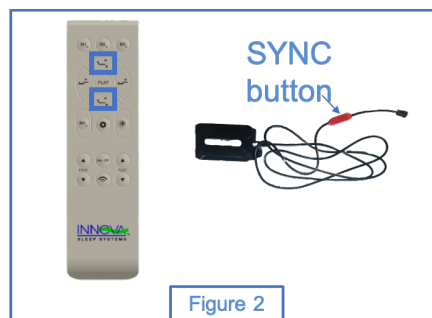

Refer to page 14 for instructions for syncing two remotes to the same base or using one remote for two bases.

WE STRONGLY RECOMMEND:

In order to help protect your investment in case of a power surge or outage, use an electrical surge protection device with a battery backup system (not included) and plug it in to a grounded outlet.

Install Bluetooth Add-on by following the Bluetooth Receiver Instruction. If not, skip to step 7.

Bluetooth Receiver Instruction



1. Ensure Base is in Flat Position

You will have a total of 20 seconds from the time the control box is powered on to sync the remote and then sync the bluetooth receiver. To provide the most time possible for these steps, ensure the base is in a flat position before syncing the remote. To do this, make sure the base is plugged into the wall outlet, then press the red sync button on the DC Cord. The control box will beep and the base will return to flat. Unplug the base and proceed to Step 2.

2. Connect and Sync the Bluetooth Receiver with Control Box

a) Connect the bluetooth receiver between the AC Adaptor (Battery Transformer) and the DC Cord (with red sync button that plugs into the control box). (See Picture Diagram to the Right)

b) After the base is plugged into the wall outlet, the control box will beep.

While beeping, press and hold the (HEAD UP)  + (HEAD DOWN)  buttons on the remote at the same time until you hear a second beeping sound. This indicates that the remote and the control box have successfully synced.

c) After the second beeping, immediately press and hold the (Flat) **FLAT** + (HEAD DOWN)  buttons on the remote until you hear a third beeping sound. This indicates that the bluetooth receiver and the control box have successfully synced.

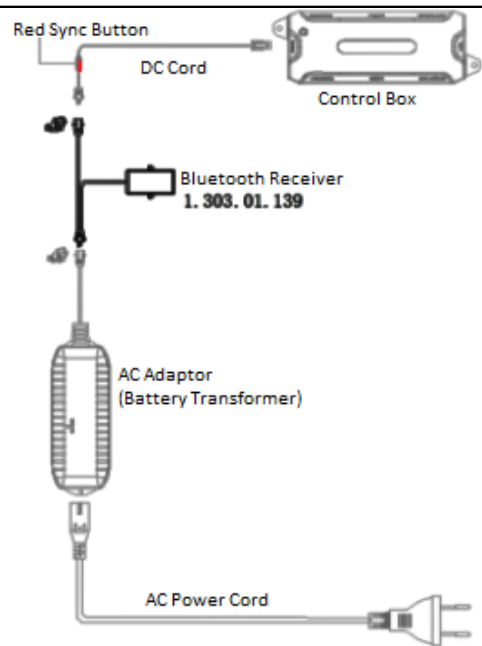

Troubleshooting:

- If you have not heard the series of beeping, the remote and the control box or the control box and the bluetooth receiver may not have paired - Repeat steps 2a-2c.
- If the base was not flat to begin with when the control box was powered on, the time it takes to lower the base to flat will be deducted from the 20 second time limit (Repeat Steps 1-2).
- If steps 1-2 have been successfully completed but the base powers off, only the remote and control box will need to be synced again, not the bluetooth receiver.
- If a bluetooth receiver has already been synced to a phone, only the remote and control box need to be synced after power goes out or after installing a new control box and/or remote.

3. App Installation and Use

*The app cannot connect the same bluetooth receiver to more than 1 device at the same time. To switch devices, the app must be closed on the first device and the second device must then follow steps 1-3 initially. For subsequent connections only follow Step 3b-d. *

a) Open the mobile app store on your Apple or Android device. Search for the “INNOVA Sleep System” app and download.

Scan the QR Code for Apple

or

Scan the QR Code for Android



Apple App Store
Innova Sleep
Innova Sleep Systems



Android App Store
INNOVA Sleep System
Huzhou Haidemu Intelligence Technology

b) Open the app and click the gear icon in the top right corner. Then, click on Bluetooth. Select the INNOVA# bluetooth receiver (the # corresponds to the # located on the Bluetooth Receiver box). If the INNOVA# bluetooth receiver does not appear, the sync has not been successful - repeat steps 1-2. (CONTINUED ON PAGE 2)

Bluetooth Receiver Instruction

App Installation and Use Continued

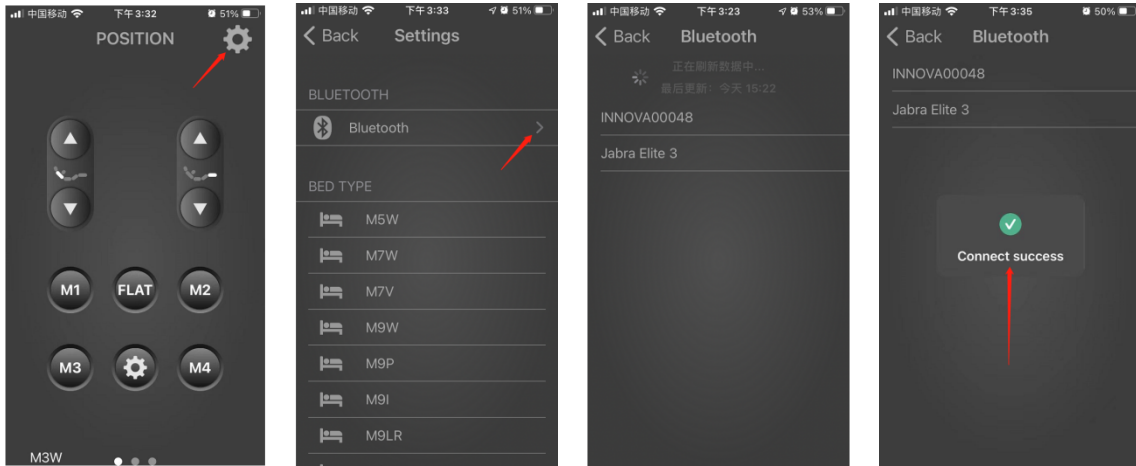

c) Once a bluetooth receiver is synced with any device following steps 1-3b, the bluetooth receiver will automatically be detected on the device. The bluetooth receiver will only need to be synced again if a new control box, remote, or device is connected.

d) Select the corresponding bed model to access the correct bluetooth remote for your base. Each bluetooth remote is divided into three sections: bed lift operation, massage operation and alarm clock operation.



Service telephone: 1-877-386-1373

Install USB Add-on by following the USB CHARGER ADD-ON Instruction. If not, skip to step 7.

INNOVA ELECTRONICS - USB CHARGER ADD-ON

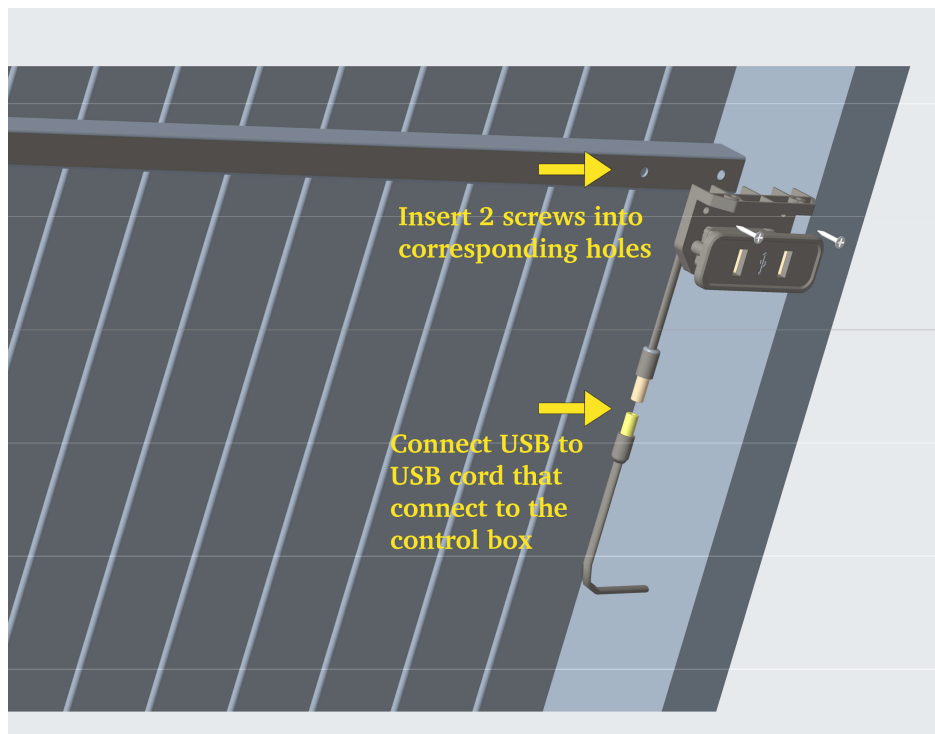
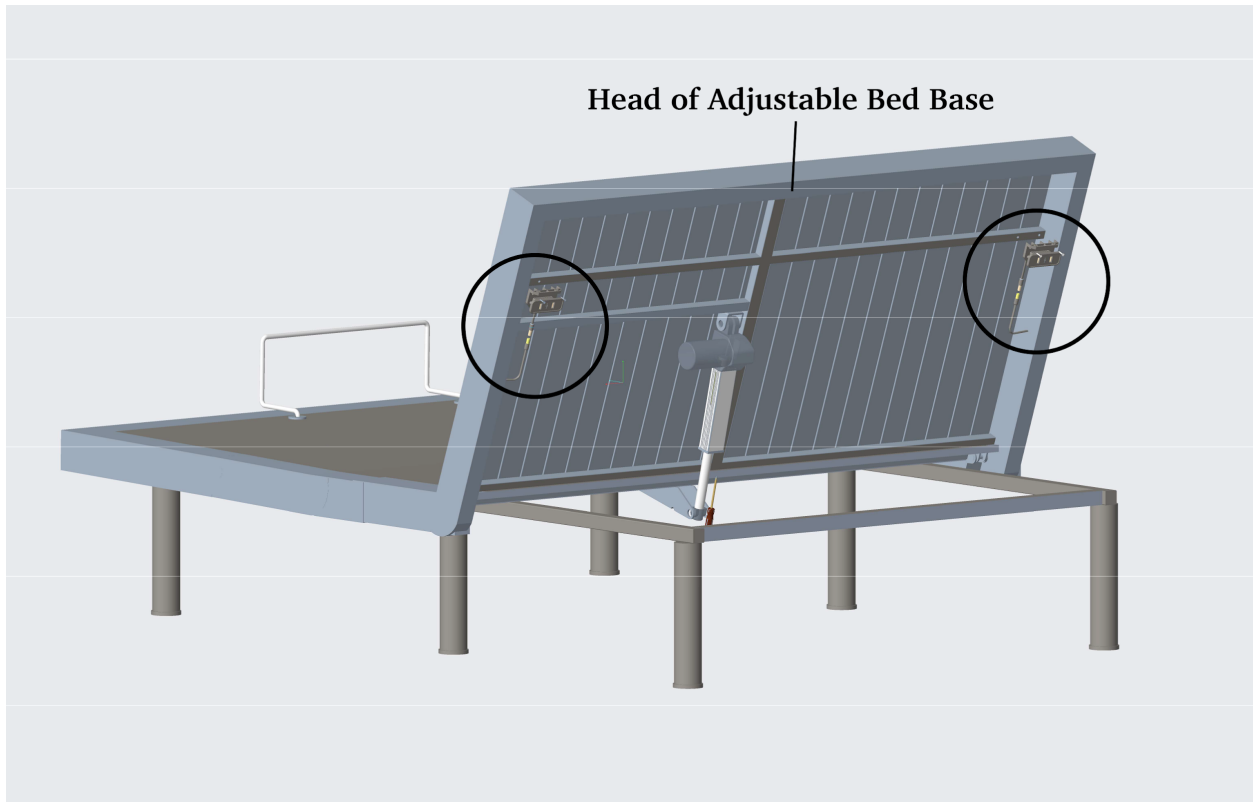

Step 7:

Unplug the Power Cord.

Install the six legs(seven legs for KING size bases) firmly into the base of the frame. The legs screw into the threaded holes around the perimeter of the adjustable base frame (See Figure 3).

The legs are stackable and are 3",4" and 6". The combination gives you a set of six (seven for KING size bases) 4", 6",7",9", 10" or 13"legs. The minimum height for this base is 4".

Do not over tighten.

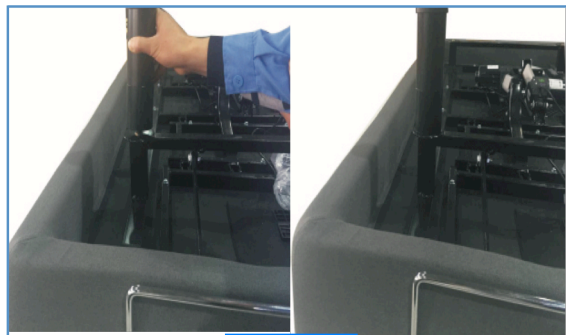

Figure 3

Step 8:

With the help of your able-bodied assistant, carefully lift the adjustable bed frame and set it in place upright on its legs. Excessive pressure and dragging the bed without lifting may damage the legs. Remove all protective plastic covering.

Note: Check and make sure that all power cords are untangled and do not interfere with any adjustable bed mechanisms.

Dispose of covering properly to avoid injury.

Step 9:

Note: The Mattress Retaining Bar is tied to the underside of the base for shipping.

Insert the Mattress Retaining Bar by carefully aligning and pushing the bar into the holders at the foot of the bed. (Figure 4)

The Mattress Retaining Bar prevents the mattress from slipping off the base and should not be used as a handle of the base. Using as a handle will damage the retaining bar holders.

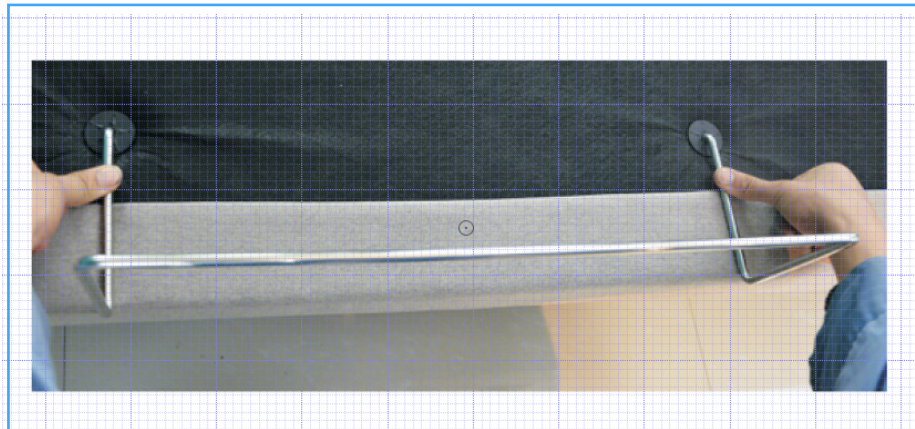

Figure 4

**Setup is now complete.
Plug your base back in and enjoy your new adjustable bed.**

Wireless Remote Control Instructions

**For toll-free customer service, call 1-877-386-1373 (US) or 1-833-486-8334 (Canada)
or email us: service@innovasleep.com**

Please tell us your name, phone, address, Model Name and/or Model ID (found on the law label tags, which are stapled to the head of the base), purchase date, and your question or concern when you call or email.



Figure 5

How to Program Memory Position Buttons:

The remote has 4 memory buttons: "M1", "M2", "M3", and "M4". These positions have been tested but have not been preprogrammed, as each user will have his/her own individual preferences.

1. In order to set each button, adjust the bed to the desired position.
2. Press and hold the memory button and the set button for 3 seconds simultaneously. A quick beeping sound will confirm that the setting has been successfully saved.
3. Each of the 4 position buttons (M1, M2, M3, or M4) can be reset by repeating steps 1 and 2.



Figure 6

How to Set and Remove Child Safety Locks:

The Child Safety Locks prevent the head and foot of the bed from moving from current position until they are turned off. When the Child Safety Locks are engaged, the Remote will not sync to the Control Box.

To turn on Child Safety Locks:

Press the SET and HEAD UP buttons simultaneously for 5-8 seconds (Figure 7). The quick beeping sound will confirm the locks have been activated.



Figure 7

To turn off Child Safety Locks:

Press the SET and HEAD DOWN buttons simultaneously for around 5-8 seconds (Figure 8). The quick beeping sound will confirm the locks have been deactivated.



Figure 8

SYNCHRONIZING TWO BEDS

The bed base is designed to allow two twin XL bases to become an Eastern King base and two Split-Cal-King bases to become a Cal-King base. You can use the same Remote to control two side-by-side beds bases by following Step 6 on the installation guide to synchronize one Remote with the two Control Boxes of the two units.

- After base A is paired by following the directions in Step 6, plug in base B and wait for the base to return to flat. You will hear a beep, and it will enter the syncing state for 10 seconds. (If not synced within 10 seconds, please press the orange SYNC button to enter the syncing mode on base B.)
- Using the same remote, simultaneously press the FOOT UP and FOOT DOWN button for 3-5 seconds.
- You will hear another beep to signal syncing is complete.



Figure 9

USING BOTH REMOTES ON THE SAME BED

- Sync the Remote A with the 2 control boxes(control box A first,control box B second) by following the above directions for Synchronizing Two Beds.
- Then sync the Remote B with the 2 control boxes(control box B first, control box A second) by following the above directions for Synchronizing Two Beds.
- Now both Wireless Remotes will be able to control both beds.

DESYNCHRONIZING TWO REMOTES

To remove syncing on one remote, press the orange SYNC button for 3-5 seconds. You will hear a beep to confirm that the base is ready to sync. To sync again, refer to Step 6 to sync base A with remote A. Then, press the orange SYNC button on base B and sync with Remote B.

UPPERFLEX FEATURE:

This feature allows both heads of two twin xl bases to operate separately while both feet operate simultaneously.

USING UPPERFLEX FUNCTION:

In order to use this function, follow the above processes for "SYNCHRONIZING TWO BEDS" and "USING BOTH REMOTES ON THE SAME BED." Once these two processes are enabled, follow the instructions below:

- Using the remote A or remote B, press and hold the FOOT UP button and the SET button for 3 seconds simultaneously (See Figure 10). A quick beeping sound will confirm that the setting is successful.



Figure 10

REMOVE UPPERFLEX FUNCTION:

- Using the remote A or remote B, press and hold the FOOT DOWN button and the SET button for 3 seconds simultaneously (See Figure 11). A quick beeping sound will confirm that the setting is successful.



Figure 11

INNOVA SLEEP PRODUCT 1, 3 & 10 YEAR LIMITED WARRANTY

YOUR INNOVA ADJUSTABLE BED BASE (the “Product”) IS COVERED BY THE LIMITED WARRANTY SET FORTH HEREIN.

THIS LIMITED WARRANTY GIVES YOU SPECIFIC LEGAL RIGHTS, AND YOU MAY ALSO HAVE OTHER RIGHTS WHICH VARY FROM STATE TO STATE.

WE WARRANT THAT DURING THE APPLICABLE WARRANTY PERIOD, THE PRODUCT WILL BE FREE FROM DEFECTS IN MATERIALS AND WORKMANSHIP.

INNOVA’S RESPONSIBILITY FOR DEFECTIVE PRODUCTS IS LIMITED TO REPAIR OR REPLACEMENT AS DESCRIBED BELOW.

WHO MAY USE THIS WARRANTY?

Innova Sleep Products, Inc. (“Innova”) extends this limited warranty only to the consumer who is the original purchaser of a new Product (the “Purchaser”). It does not extend to any subsequent owner or other transferee of the Product. Floor model Products and Products sold expressly “as is” are not covered by this limited warranty.

WHAT DOES THIS WARRANTY COVER?

This limited warranty covers defects in materials and workmanship of the Product for the applicable Warranty Period specified below.

WHAT IS NOT COVERED BY THIS WARRANTY?

This limited warranty does not cover any damage due to: (i) transportation, (ii) storage, (iii) improper use, such as use other than personal use in-home exclusively by the Purchaser, (iv) failure to follow the Product operation and maintenance instructions in the Owner’s Manual, this limited warranty, or the Product Precautions, (v) modifications, (vi) unauthorized repair, (vii) normal wear and tear, and/or (viii) external causes such as accidents, abuse, or other actions or events beyond Innova’s reasonable control. This limited warranty also does not cover (a) damage to any products or materials used with, but not constituting or comprising, a Product (including but not limited to mattresses, fabric, cables, electrical cords or items supplied by dealers), (b) the costs of service calls unrelated to any defect (such as in connection with removal, installation, setup, in-home service calls solely for the purpose of educating the Purchaser about the Product or assistance with locating appropriate power connections), and/or (c) reimbursement for inconvenience, loss of use or any other costs or expenses.



WHAT IS THE PERIOD OF COVERAGE?

This limited warranty commences on the Purchaser's date of purchase and lasts for the periods set forth below (the "Warranty Period"), and will not be extended if Innova repairs or replaces any Product or part:

Part Name	Parts Warranty Period	Labor Warranty Period
Motor	3 Year	1 Year
Transformer(s)	3 Year	1 Year
Control Box(es)	3 Year	1 Year
Massage Unit	1 Year	1 Year
Underbed Light	1 Year	
Remote Control	1 Year	
USB Chargers Add-on	1 Year	
Bluetooth Add-on	1 Year	
Frame	10 Year	

WHAT ARE THE PURCHASER'S REMEDIES UNDER THIS WARRANTY?

Year One: Full Labor and Parts Coverage

With respect to any defective Product or part thereof (as listed above) during the first year of the Warranty Period, Innova will, in its sole discretion, either: (i) repair such Product (or the defective part) free of charge to the Purchaser, or (ii) replace the Product (or the defective part) with new or refurbished Product(s) or part(s) free of charge to the Purchaser. Innova will pay all authorized labor and transportation costs associated with any such repair or replacement.

Years Two and Three: Limited Parts Coverage

With respect to any defective Motor, Transformer, Control Box or Frame part(s) during the second and third years of the Warranty Period, Innova will, in its sole discretion, either: (i) repair such Product (or the defective part) free of charge to the Purchaser, or (ii) replace the Product (or the defective part) with new or refurbished Product(s) or part(s); provided, however, that the Purchaser shall be responsible for the cost of all authorized labor and transportation costs associated with any such repair or replacement. This limited warranty shall not apply if the Purchaser does not return any and all defective parts to Innova promptly following Innova's request.

Years Four through Ten: Limited Frame Coverage

With respect to any mechanical part of the Product frame found to be defective during the fourth through tenth years of the Warranty Period, Innova will, in its sole discretion, either: (i) repair such part free of charge to the Purchaser, or (ii) replace the defective part(s) with new or refurbished Product(s) or part(s); provided, however, that the Purchaser shall be responsible for: (a) all transportation costs associated with any such repair or

replacement and (b) if the Product is replaced, the Purchaser shall pay to Innova an amount equal to one-tenth (1/10) of the then-current replacement cost, times the number of years that have elapsed during the Warranty Period as of the time the warranty claim is made. This limited warranty shall not apply if the Purchaser does not return any and all defective parts to Innova promptly following Innova's request.

HOW CAN THE PURCHASER OBTAIN WARRANTY SERVICE?

To obtain warranty service, the Purchaser must call 1-877-386-1373 (US) or 1-833-486-8334 (Canada) or email Innova customer service at service@innovasleep.com during the Warranty Period. No warranty service will be provided, nor may any warranty claim be made, without: (i) the law label tags (see below for information on locating the law labels), and (ii) a sales receipt/proof of purchase showing the date of purchase, the amount paid and the place of purchase.

Innova and/or its service technicians shall not be responsible for moving furniture or any other items not attached to the Product in order to perform service on the Product. It is the sole responsibility of the Purchaser to provide adequate space and accessibility to the Product. In the event that Innova is unable to perform service due to lack of accessibility, the service call will be billed to the Purchaser and the service will have to be rescheduled.

Finding the Law Label

The law label is needed to verify all warranty claims. To locate the law label tags, use remote to bring head of base all the way up so that the base is in the below position:



The law label is stapled to the head of the Product base as seen below:

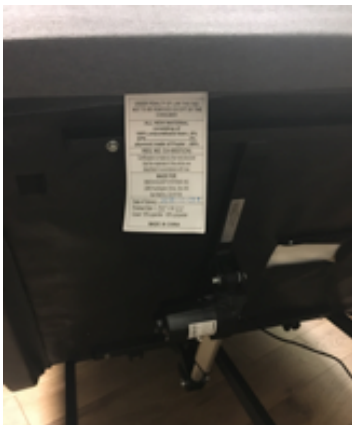

Manufactured By:
Cixi Star Alliance Smart Furniture Co., Ltd
No. 988 Ciding North Avenue, Coastal
Economic Development Zone,
Cixi City, Zhejiang Province, China

Date of Manufacture:

Importer/U.S. Records Location:
Innova Sleep Systems Inc.
2290 Huntington Drive, Ste 200
San Marino, CA 91108.

Model ID: **SEB035W II**
Prototype ID: Multiple
Foundation ID: **DELIGHT II**

 **WARNING:**
This product can expose you to chemicals including Di(2-ethylhexyl) phthalate (DEHP), which are known to the State of California to cause cancer or birth defects or other reproductive harm. For more information go to www.P65Warnings.ca.gov.

UNDER PENALTY OF LAW THIS TAG NOT TO BE REMOVED EXCEPT BY THE CONSUMER

ALL NEW MATERIAL consisting of
100% polyurethane foam...6%
EPE...8%
plywood made of Poplar...89%

REG. NO. CA 45537(CN)

Certification is made by the manufacturer that the materials in this article are described in accordance with law.

MADE FOR
INNOVA SLEEP SYSTEMS INC
2290 Huntington Drive, Ste 200
San Marino, CA 91108.

Date of Delivery:
Finished Size: L 79.5" X W 59.5"
Cover: 100% polyester

MADE IN CHINA

LIMITATION OF LIABILITY; DISCLAIMERS

THE REMEDIES DESCRIBED ABOVE ARE THE PURCHASER'S SOLE AND EXCLUSIVE REMEDIES AND INNOVA'S ENTIRE LIABILITY UNDER THIS LIMITED WARRANTY. INNOVA'S LIABILITY SHALL UNDER NO CIRCUMSTANCES EXCEED THE ACTUAL AMOUNT PAID BY THE PURCHASER FOR THE DEFECTIVE PRODUCT, NOR SHALL INNOVA UNDER ANY CIRCUMSTANCES BE LIABLE FOR ANY CONSEQUENTIAL, INCIDENTAL, SPECIAL OR PUNITIVE DAMAGES OR LOSSES, WHETHER DIRECT OR INDIRECT.

SOME STATES DO NOT ALLOW THE EXCLUSION OR LIMITATION OF INCIDENTAL OR CONSEQUENTIAL DAMAGES, SO THE ABOVE LIMITATION OR EXCLUSION MAY NOT APPLY TO CERTAIN PURCHASERS.

THE EXTENT PERMITTED BY LAW, THIS WARRANTY AND THE REMEDIES SET FORTH HEREIN ARE EXCLUSIVE AND IN LIEU OF ALL OTHER WARRANTIES, REMEDIES AND CONDITIONS, WHETHER ORAL, WRITTEN, STATUTORY, EXPRESS OR IMPLIED, INCLUDING WITHOUT LIMITATION, WARRANTIES OF MERCHANTABILITY AND FITNESS FOR A PARTICULAR PURPOSE AND WARRANTIES AGAINST HIDDEN OR LATENT DEFECTS. IN SO FAR AS SUCH WARRANTIES CANNOT BE DISCLAIMED, INNOVA LIMITS THE DURATION AND REMEDIES OF ALL IMPLIED WARRANTIES, INCLUDING WITHOUT LIMITATION, THE WARRANTIES OF MERCHANTABILITY AND FITNESS FOR A PARTICULAR PURPOSE TO THE DURATION OF THIS WRITTEN WARRANTY.

SOME STATES DO NOT ALLOW EXCLUSIONS OR LIMITATIONS ON HOW LONG AN IMPLIED WARRANTY MAY LAST, SO THE ABOVE LIMITATION MAY NOT APPLY TO YOU.

TROUBLESHOOTING

Remote doesn't light up or bed works intermittently

- Change the batteries with **3 AAA lithium batteries of any brand**.
- If your base does not work after changing the batteries, check to see if there is a green light on the Transformer, which is the black box on the floor that is attached to the Power Cord that plugs in to the surge protector or wall. Bases should be plugged into a surge protector.

Remote doesn't control the bed base

If the green light on the Transformer is **ON**

- Check the connections between the Transformer and the Control Box as well as the connections between the Control Box and the actuators.
- Verify the Child Safety Locks are not engaged.
 - Press and hold the SET and HEAD DOWN buttons until the Remote blinks to deactivate the Child Safety Locks. If the base then moves, the Child Safety Locks have been successfully taken off.
- Sync bed to the base as described in Step 6 (Page 8).

If the green light on the Transformer is **NOT ON**:

- Check the connection between the Power Cord and Transformer.
- Please unplug your base for 30 minutes and plug it back in and see if the light comes back on.
 - If it does, follow directions for when the green light is on.

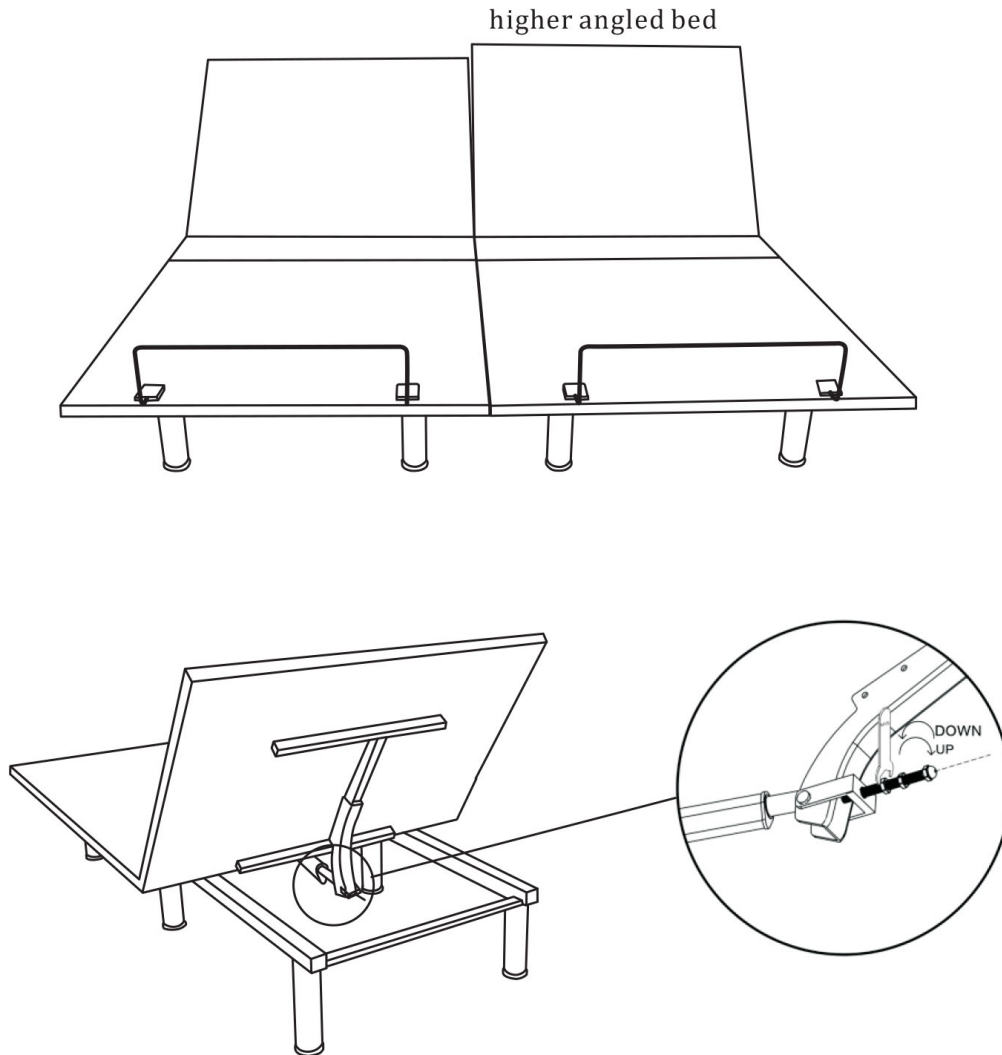

WHEN TWO BEDS DO NOT ALIGN:

On the higher angled bed of the two, use a 19mm wrench to turn the nuts on the Level Right mechanism counterclockwise to adjust the angle until the higher angle bed matches the level of the lower angle bed and lock the nut with the reinforcement nuts.



**For toll-free customer service, call 1-877-386-1373 (US) or
1-833-486-8334 (Canada) or email
service@innovasleep.com**

Please tell us your name, phone, address, Model Number/ID (found on the law label tags, which are stapled to the head of the base), purchase date, and the question or concern when you call or email.

A bed that moves you.

