

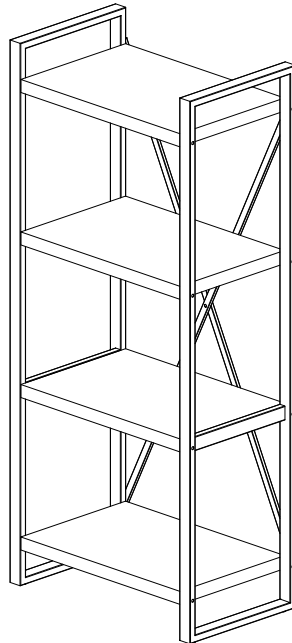

SHELF TABLETTE

Item No/No Article: HF-YD2305

Sku No/No.UGS: 02F68001



**DO NOT return to the store if parts are missing or damaged.
THIS INSTRUCTION BOOKLET CONTAINS IMPOTANT SAFETY INFORMATION.
PLEASE READ AND KEEP FOR FUTURE REFERENCE.**

For Parts Replacements and Inquiries, please E-mail

Customerservice @ goodharvesthk.com



**NE PAS retourner au magasin s'il y a des pièces qui manquent ou qui sont abîmées.
CE MODE D'EMPLOI CONTIENT DES CONSIGNES DE SÉCURITÉ IMPORTANTES.
DE LES LIRE ET DE LES GARDER POUR RÉFÉRENCE ULTÉRIEURE.**

Pour des remplacements de pièces et des renseignements, veuillez nous envoyer votre message à l'adresse suivante **CustomerService@goodharvesthk.com**

Our Customer Service Representative will be available to assist you

Monday-Friday 8:00 am to 3:30 pm(Except Holidays).

Nos représentants du service à la clientèle seront disponibles pour vous aider, du lundi au vendredi, entre 8h00 et 15h30 (à l'exception des Jours fêlés).

IMPORTANT

 **TWO PEOPLE ARE NECESSARY FOR THE ASSEMBLY OF THIS PRODUCT.**

Before you begin: Lay out all of the parts on a non-abrasive surface in order to identify and count prior to assembly. You will need the parts and hardware listed on this instruction manual.

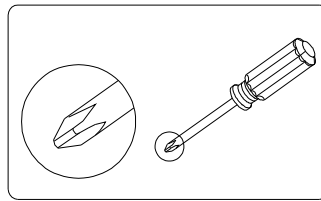













PHILLIPS HEAD SCREWDRIVER

NOW YOU ARE READY TO BEGIN ACTUAL ASSEMBLY!

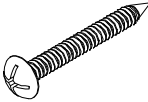
WARNING - Failure to follow these installation instructions or any other abuse, mistreatment, unreasonable use or neglect of the product shall constitute a waiver of all warranties, expressed and implied, and constitute a waiver of all claims of liability against Z-Lines Designs, Inc., its directors, officers, shareholders, parents, subsidiaries, affiliates, agents, customers and licensors, for any direct, indirect, special (including loss of revenue or income, pain and suffering, emotional distress, or similar damages), incidental, punitive, or consequential damages arising out of or resulting from the improper installation, abuse, mistreatment, unreasonable use or neglect regardless of whether such damages arise in contract, tort, under statute, in equity, at law, or otherwise.

HARDWARE IDENTIFICATION

A		WOOD SCREW 7x70x10mm	16 PCS
B		ALLEN BOLT 6x30x10mm	1 PC
C		ALLEN BOLT 6x20x10mm	4 PCS
D		WASHER	1 PC
E		FLOOR LEVELER	4 PCS
F		WRENCH	1 PC
G		WALL BRACKET	1 PC
H		WOOD SCREW 4x14x6mm	1 PC
I		WALL PLUG	1 PC
J		WOOD SCREW 4x35x6mm	1 PC
K		BOLT WASHER 13x1mm	5 PCS
L		BOLT WASHER 12x1mm	5 PCS
M		ALLEN WRENCH	1 PC

PARTS IDENTIFICATION

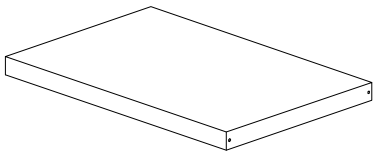
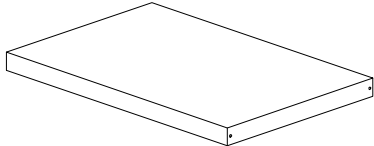
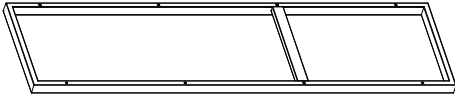
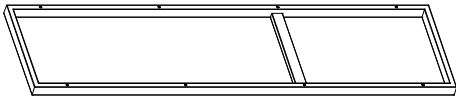
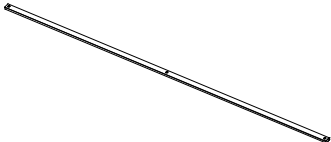
①		TOP SHELF	1 PC
②		SHELF	3 PCS
③		LEFT FRAME	1 PC
④		RIGHT FRAME	1 PC
⑤		CROSS BAR	2 PCS

ASSEMBLY INSTRUCTION

STEP 1

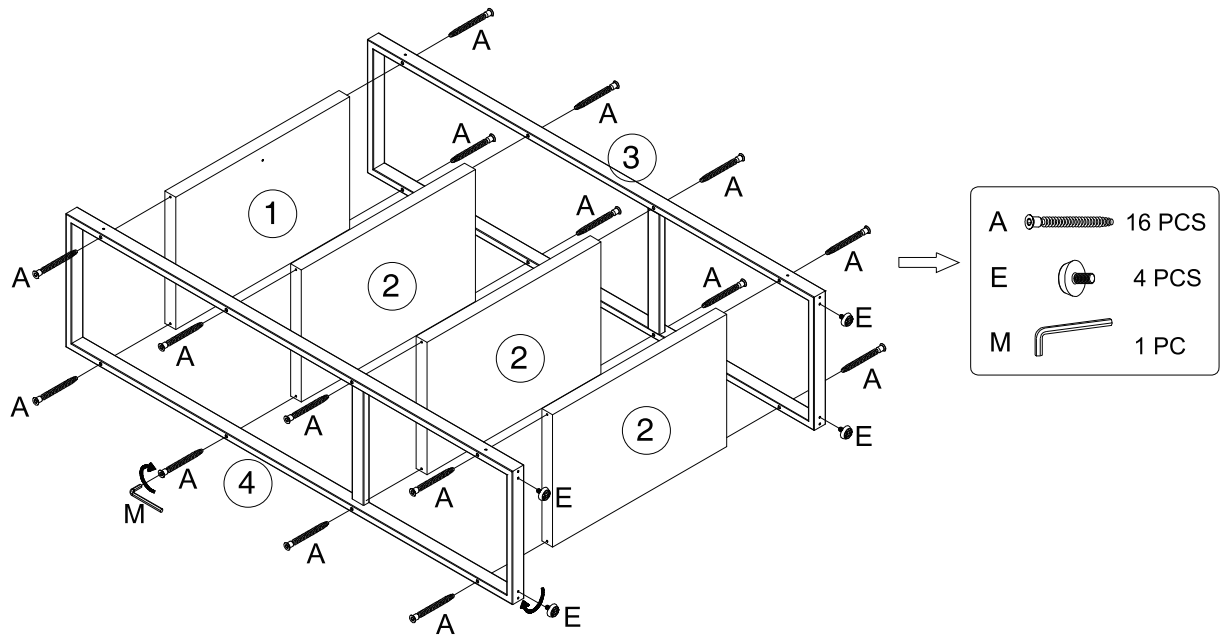

STEP 2

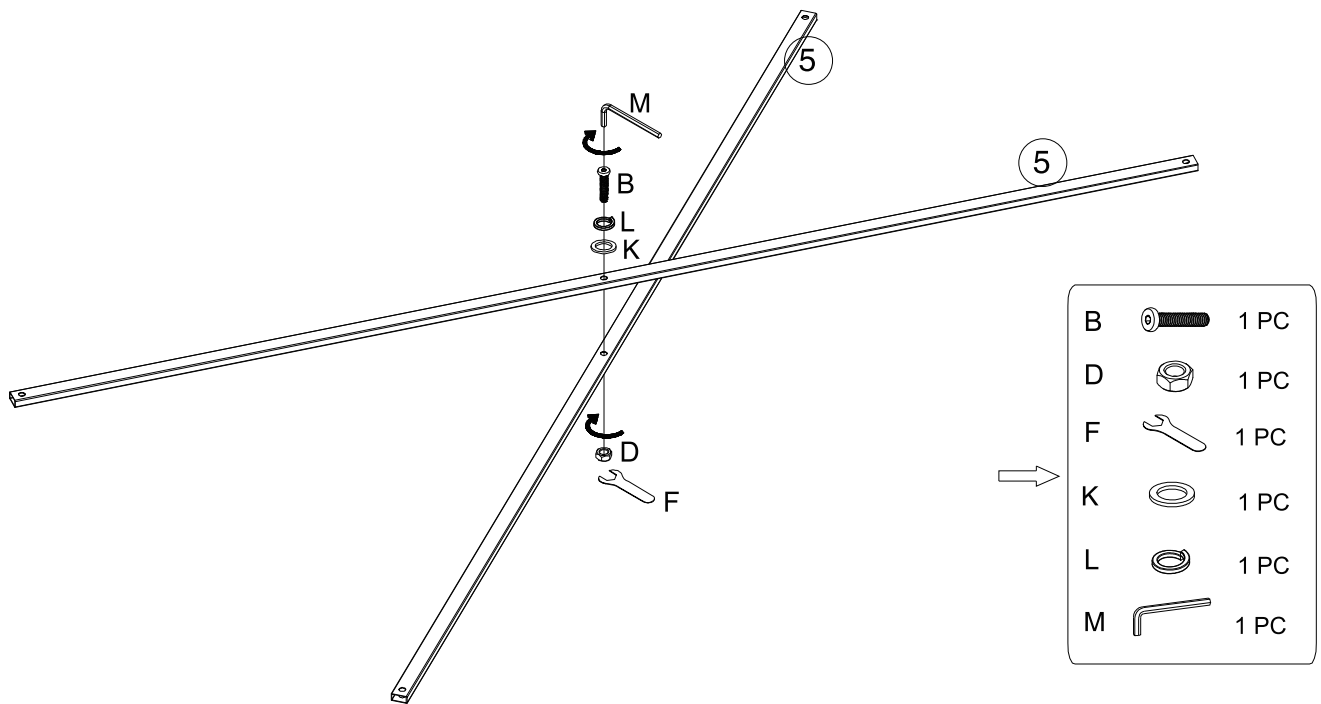

Note: Do not tighten the screws fully until you have completed Step 3 !

STEP 3

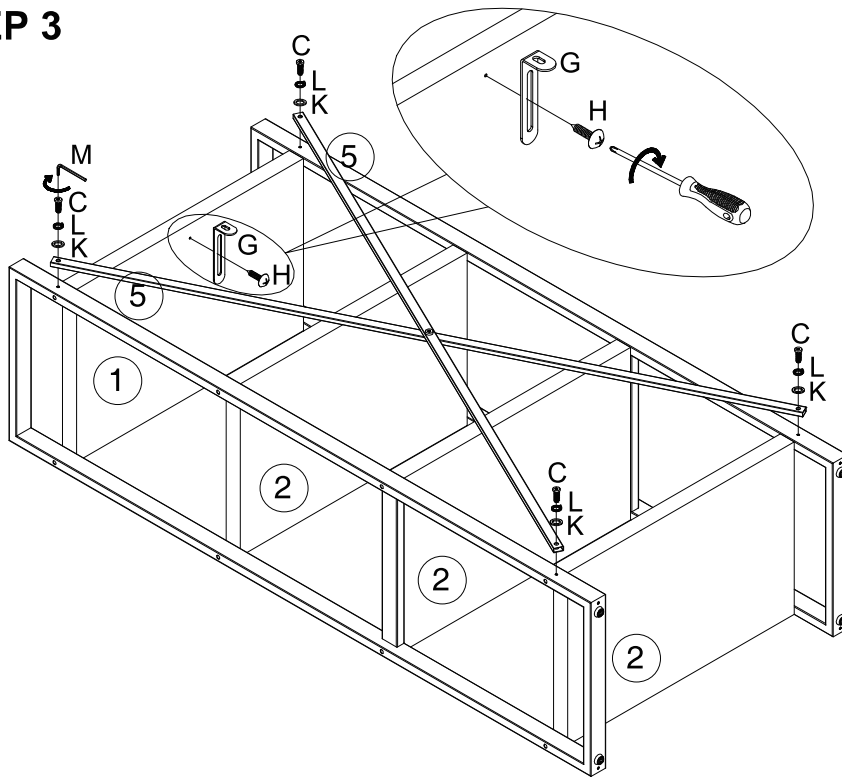

C		4 PCS
G		1 PC
H		1 PC
K		1 PC
L		1 PC
M		1 PC

STEP 4

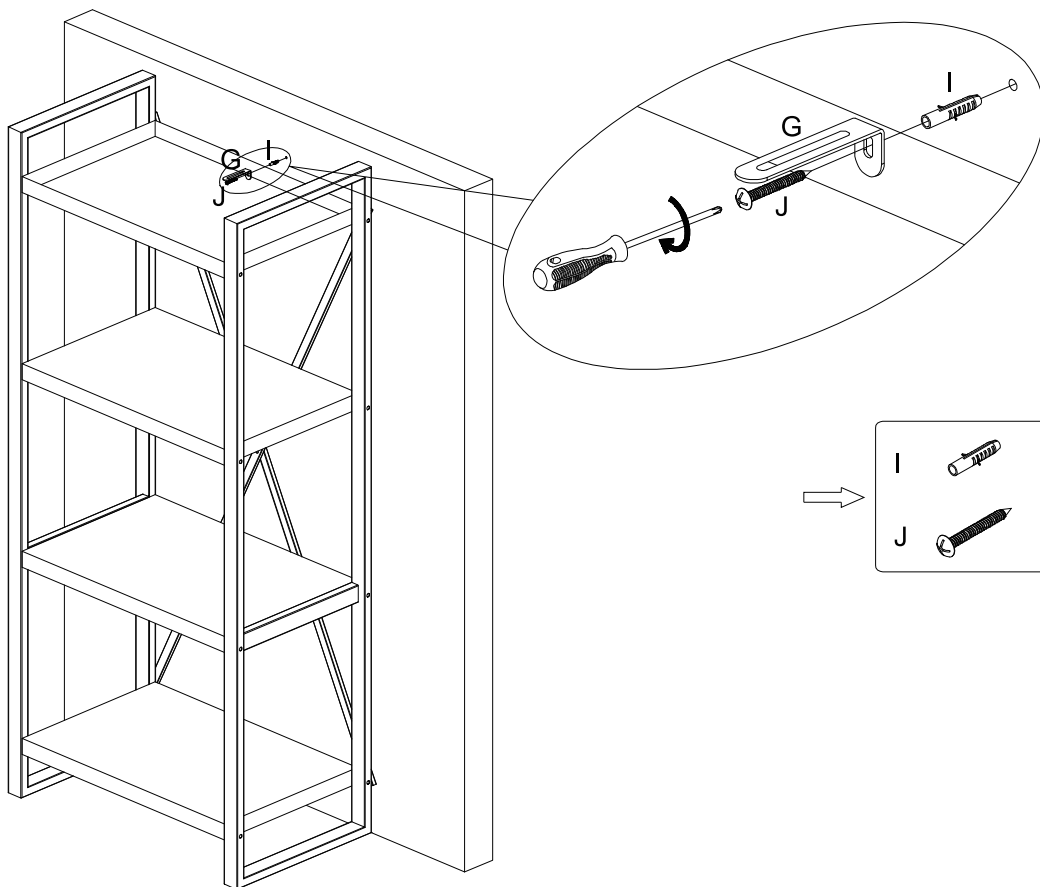

I		1 PC
J		1 PC

STEP 5

DIMENSIONS

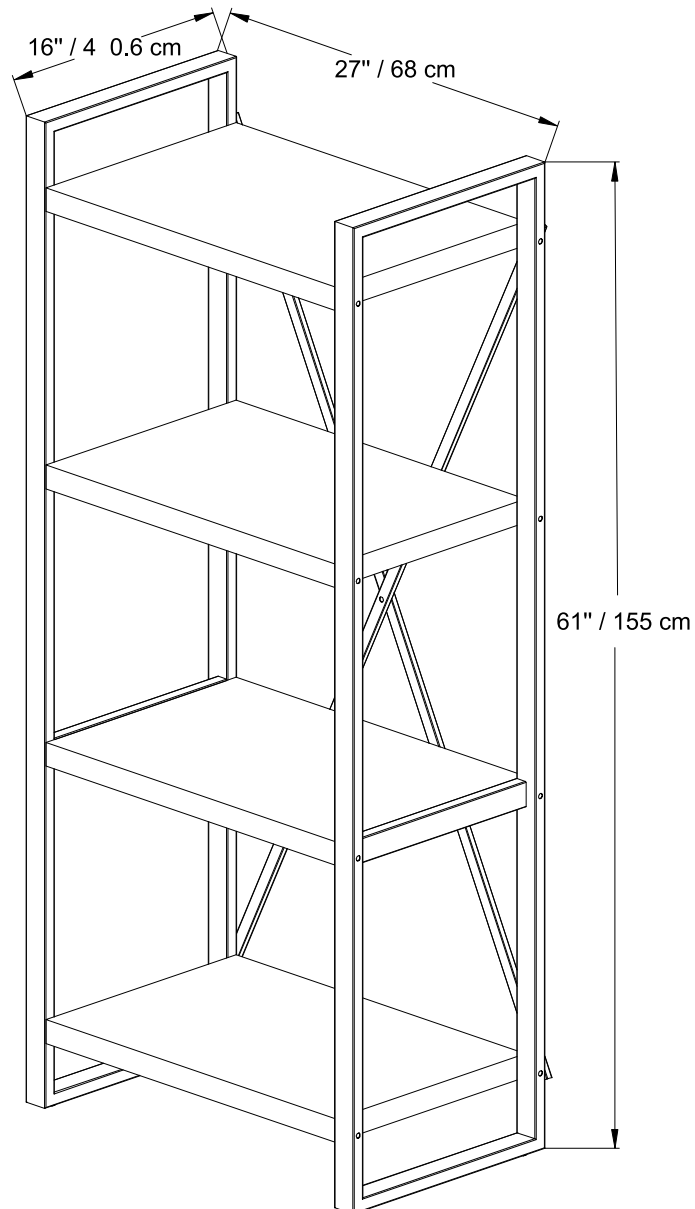

Product dimensions: (27 in W x 16 in D x 61 in H) / (68 cm W x 40.6 cm D x 155 cm H)



1 Year Limited Warranty

Thank you for purchasing a Leons' Furniture Ltd. product. We promise to repair or replace any Leons' Furniture Ltd. product or component that may have any defects in material or workmanship for 1 year after your purchase. This warranty is subject to the provisions below. Leons' Furniture Ltd.'s sole obligation and purchasers' exclusive remedy pursuant to these warranties are limited to replacement at Leons' Furniture Ltd. sole discretion. There are no other warranties except as expressly set forth below, either expressed or implied, including any warranty of merchantability for any particular purpose.

The word "defects" in this warranty is defined as Imperfections that impair the service, function or effectiveness of the product.

1YEAR:

Glides, casters and user-adjustable work surface mechanisms, laminates, veneer finishes and other materials which cover your Leons' Furniture Ltd. product.

INFORMATION ON COLOUR VARIATIONS AND FINISHES:

Some natural variations occurring in wood, or other natural materials are inherent to their character, and thus can not be avoided. Therefore they are not considered to be defects. Leons' Furniture Ltd. does not warrant the color-fastness or matching of colours, grains, textures or other such materials. Customers' own materials selected by and used at the request of a user is therefore not warranted by Leons' Furniture Ltd.

LIMITATIONS INVOLVING MATERIALS & COMPONENTS:

The materials and all components listed below are covered according to the following schedule from the date of sale to the original purchaser.

EXCLUSIONS:

This warranty does not apply to: damage caused by the carrier, modifications to the product, or attachments to the product not approved by Leons' Furniture Ltd., non-standard materials selected by and used at the request of a user, and products that were not installed, used or maintained in accordance with product Instructions and warnings. Nor shall Leons' Furniture Ltd. have any responsibility for incidental or consequential damages resulting from the breach of this Warranty, including but not limited to inconvenience, rental or purchase of replacement products, loss of profits or commercial loss. Some states do not allow the exclusion or limitation of incidental or consequential damages so the above limitation or exclusion may not apply to you. This warranty gives you specific legal rights and you may also have other rights, which may vary from state to state. This warranty applies only to products sold within the United States of America and the Commonwealth of Canada.

TO OBTAIN SERVICE FROM THIS WARRANTY:

Your Leons' Furniture Ltd.' dealer is our mutual partner in supporting your warranty requests. By following the procedures instructed below, you are assured that you will receive the best level of customer service guaranteed.

A)Please contact the local Dealer from whom you originally purchased within 30 days (**unless otherwise noted by the Dealer**) of discovery of the defect. Prepare to confirm that you are the original purchaser of the product and provide necessary product information, such as serial numbers)/ UPC numbers) from the product in question.

B)The Dealer will gather all the pertinent information required regarding your claim(s), inspect the product and thus contact a Leons' Furniture Ltd. Customer Service Representative. (Please allow a reasonable amount of time for inspection, review, and response to Dealer.

C)If the Leons' Furniture Ltd. Dealer confirms that the product in review is eligible under the warranty conditions as stated above, the customer service representative or another representative of the Company will determine whether to provide replacement parts, or authorize other arrangements at the sole discretion of the vendor, Leons' Furniture Ltd.. No assembly/labour is included in this warranty.

TO CONTACT CUSTOMER SERVICE:

Our knowledgeable Service Representatives are ready to assist you in the case this warranty applies to you. Please be prepared to explain the defect in detail, model/style number, date and location of purchase, your name, address, phone number and have your original sales receipt.

Please contact us Monday-Friday (except all major holidays)

Email us:

CustomerService@goodharvesthk.com

OR

Contact your local dealer from whom you originally purchased the product in question.