

Made in China

Thank you for purchasing this Powell product. We want to make sure it is complete and to your satisfaction. Please check all packing material carefully for small parts which may have come loose inside the carton during shipment. Hardware can be identified by bright red packaging, Separate, identify, and count all parts and hardware to make sure they match with the illustrations herein and are all present. If any part(s) are missing or defective please contact Powell Customer Service. Contact information is given at the bottom of these instructions. If you feel the item is defective beyond a resolution with part replacements, please return this product with your receipt to the place of purchase. If purchased from an internet retailer, please contact their customer service department. Photo's and additional information may be requested to validate the claim. Product is not to be returned to the Powell Company under any circumstance unless authorized by the Powell Company or an authorized dealer or representative. Thank you.

ATTENTION: SOME LETTERED PARTS LISTED ON THE INSTRUCTION SHEET MAY NOT BE IN PARTS BAG AS THEY MAY ALREADY BE ASSEMBLED. CAREFULLY CHECK PARTS AND PACKING MATERIALS PRIOR TO ORDERING REPLACEMENTS.

Tools Required for assembly: Allen Wrench (included)

WARNING: DO NOT FULLY TIGHTEN SCREWS AND BOLTS UNTIL ALL PARTS HAVE BEEN ASSEMBLED PROPERLY.
TO PREVENT SCRATCHING THE TOP SURFACE, ASSEMBLE PRODUCT ON A SMOOTH SURFACE.
DO NOT OVER TIGHTEN SCREWS AND BOLTS.

This bed is designed to use only a mattress which is 74"- 75" long and 37-1/2" - 38-1/2" wide
Ensure thickness of mattress does not exceed 8"
and surface of mattress thickness is does not less than 5"

Replacement parts, including additional guardrails, may be obtained from Powell Company.

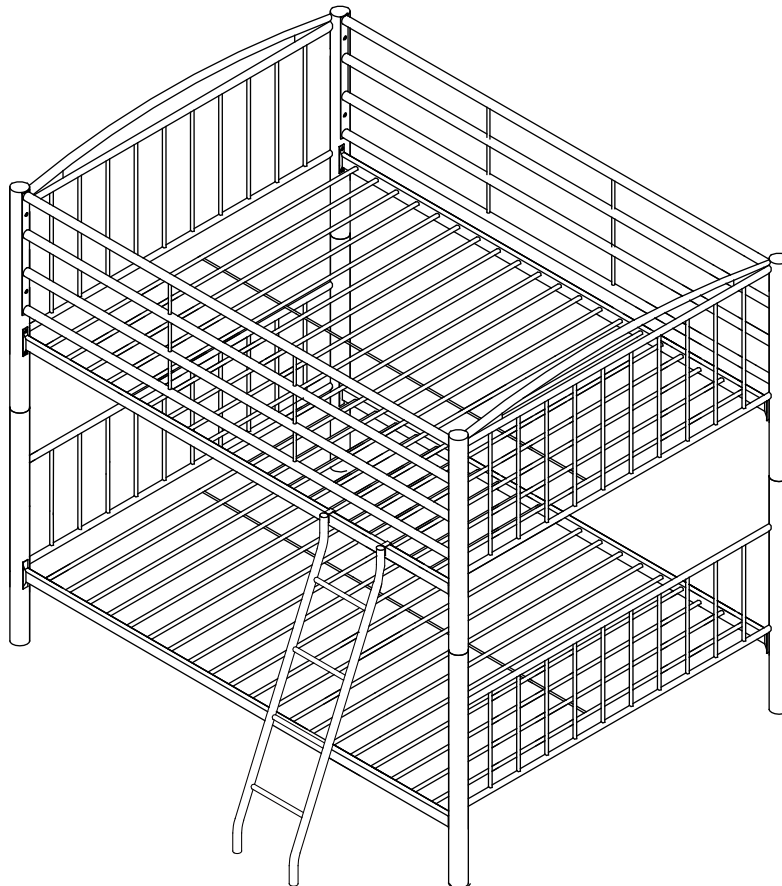

PARTS

- (A) UPPER PANELS(2)
- (B) LOWER PANELS(2)
- (C) LOWER BED FRAME
- (D) UPPER BED FRAME
- (E) GUARDRAILS(2)
- (F) LADDER
- (G) CONNECTION POSTS(4)
- (N) CAPS(8)

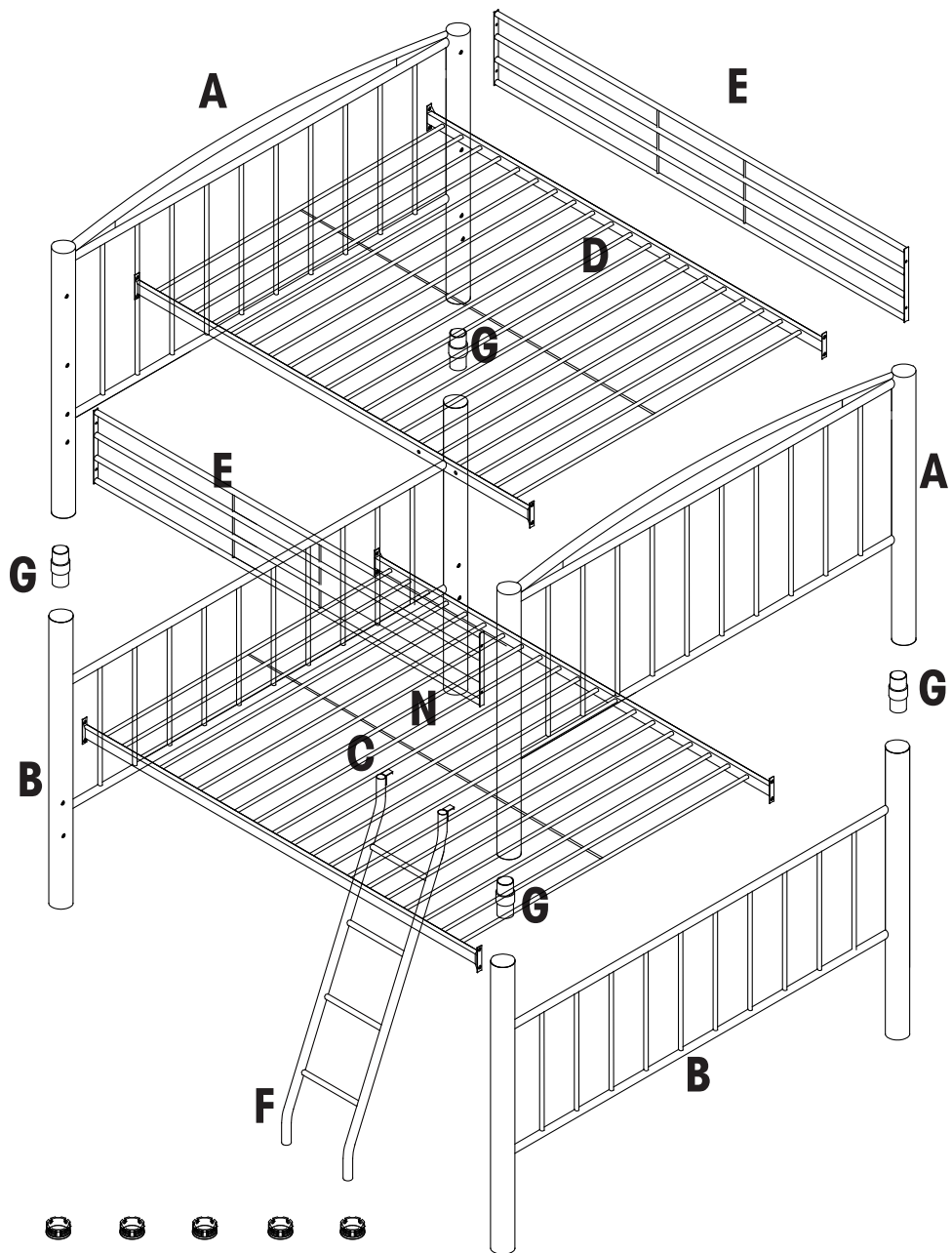

HARDWARE

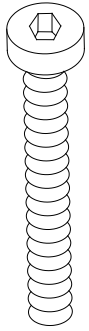

H
(2 PCS)

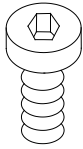

I
(8 PCS)

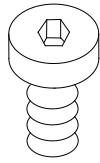

J
(16 PCS)

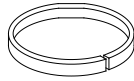

K
(16 PCS)

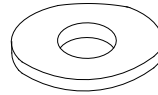

L
(16 PCS)

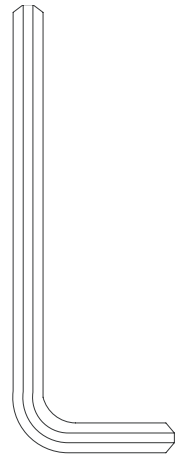

M
(1 PC)

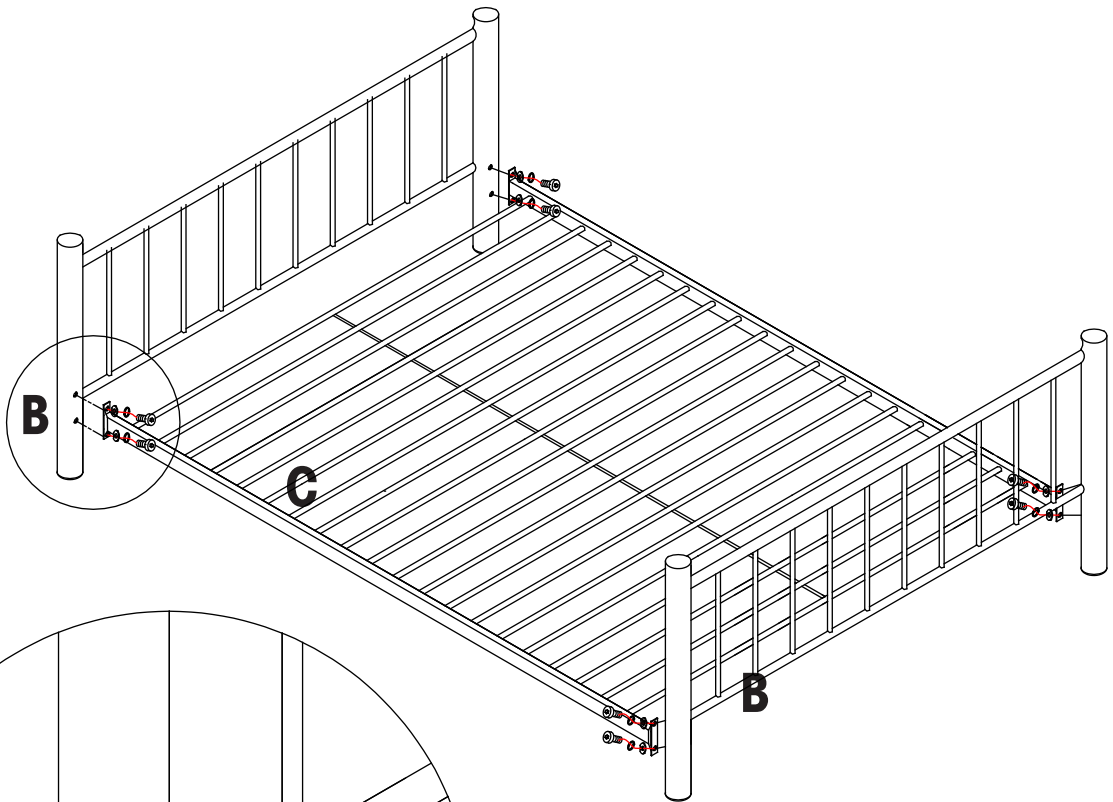

STEP 1

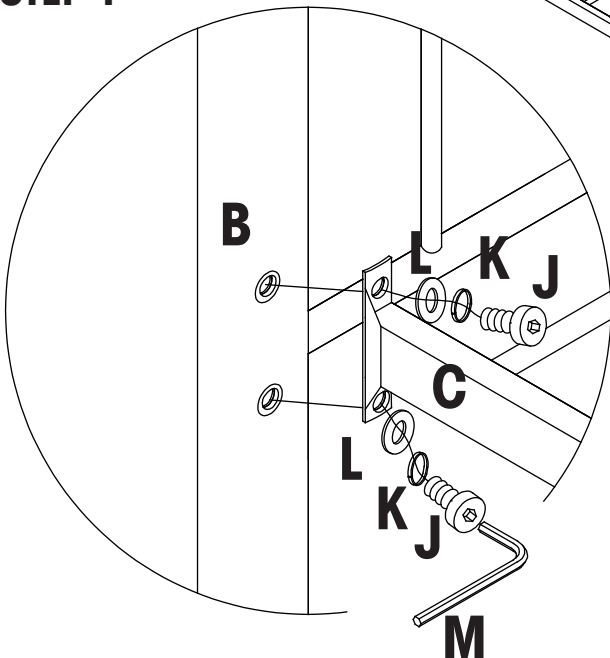

STEP 2

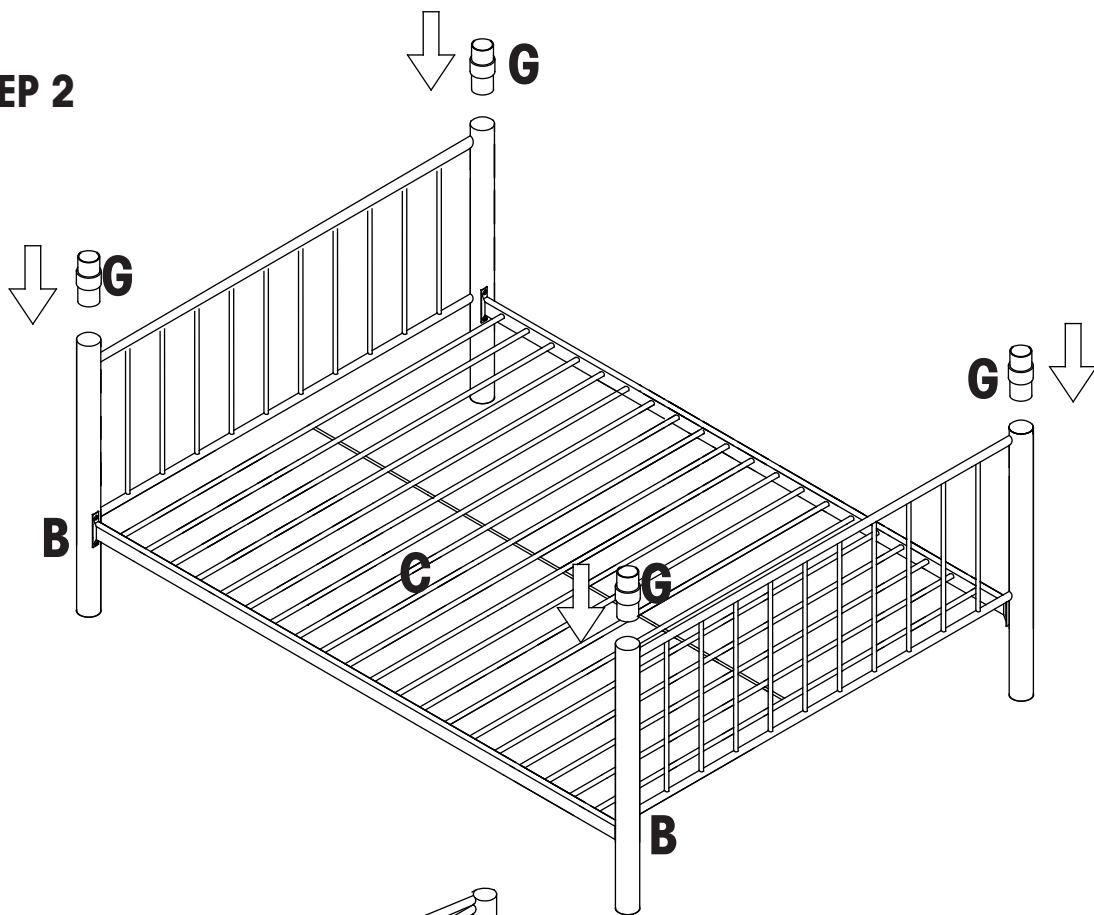

STEP 3

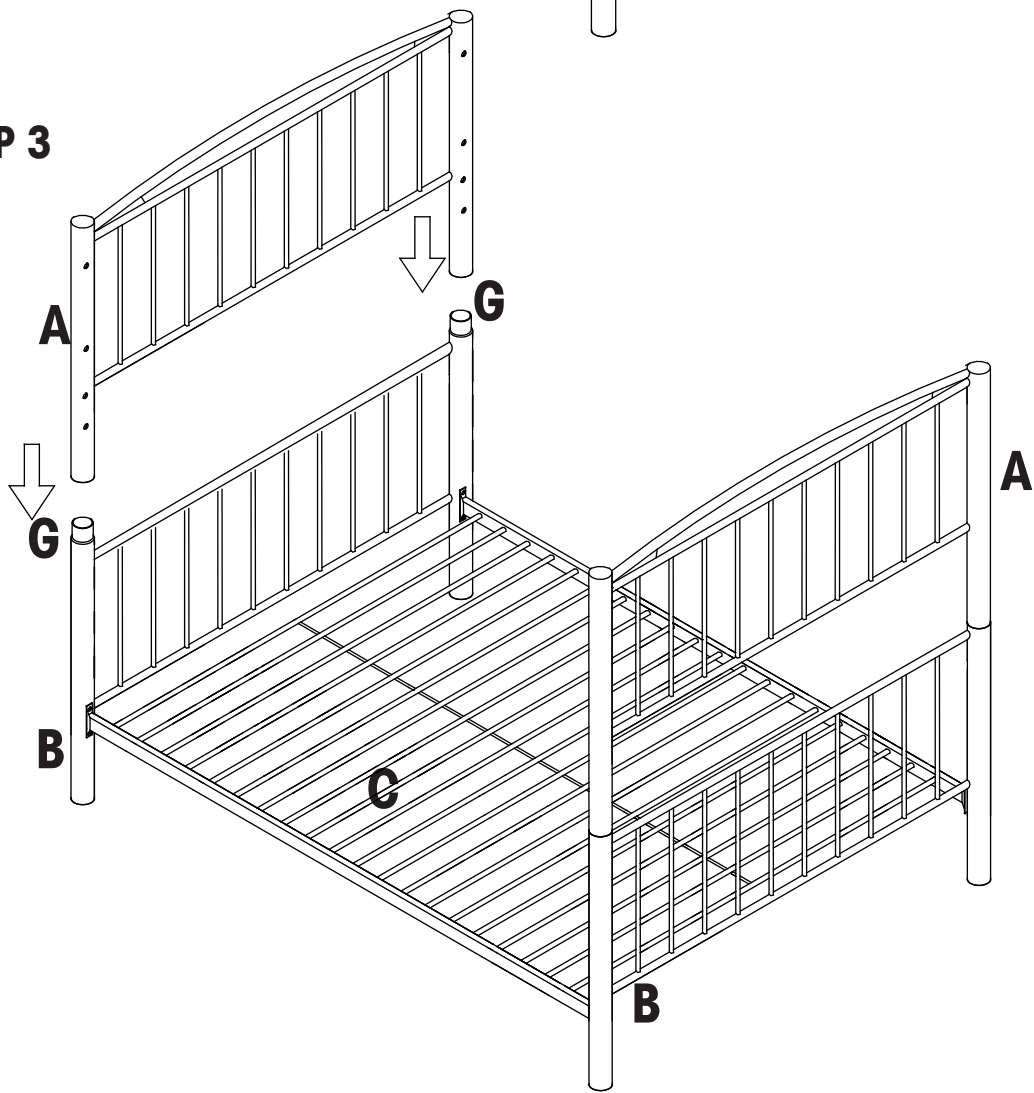

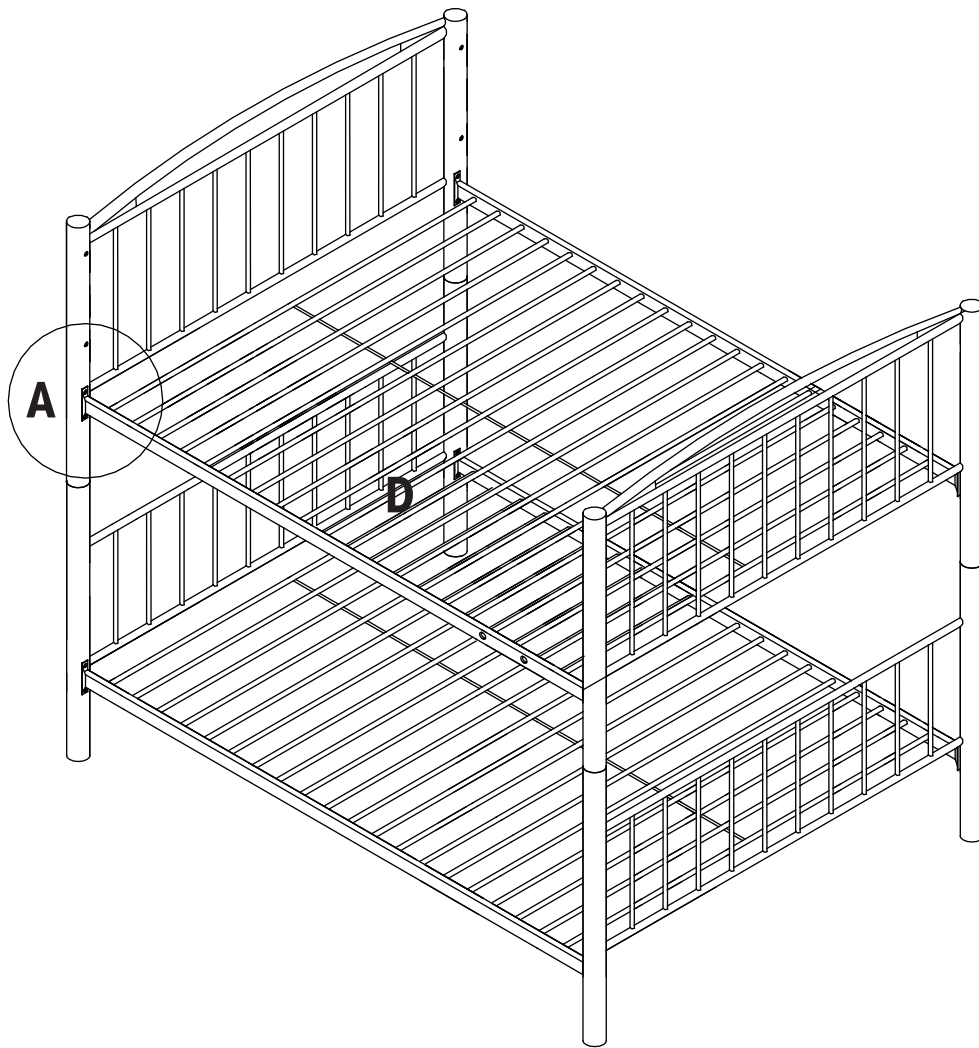

STEP 4

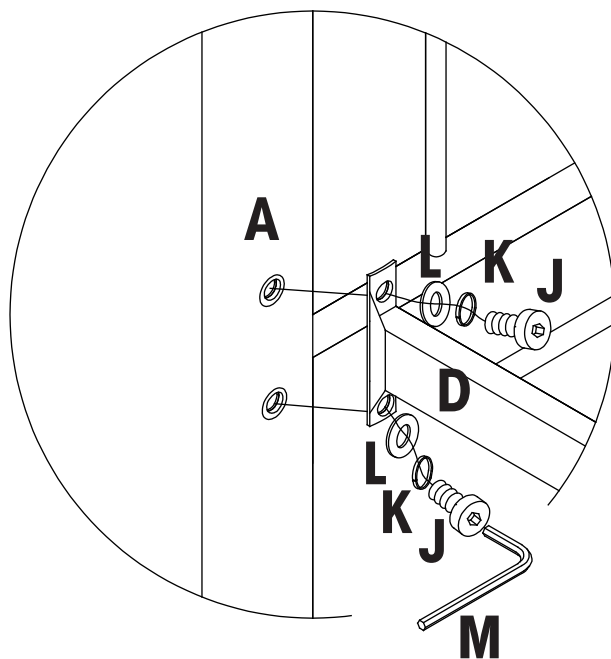

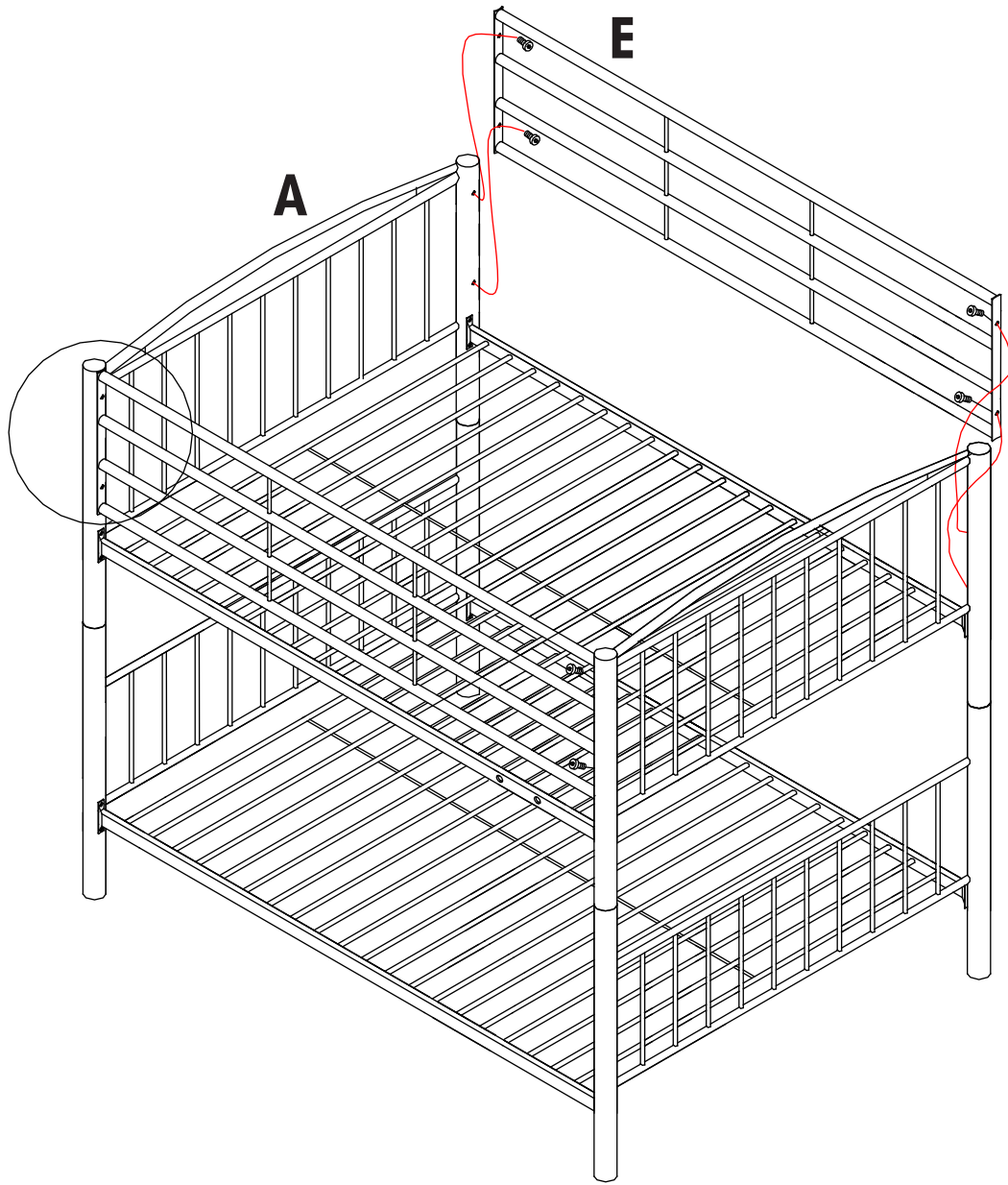

STEP 5

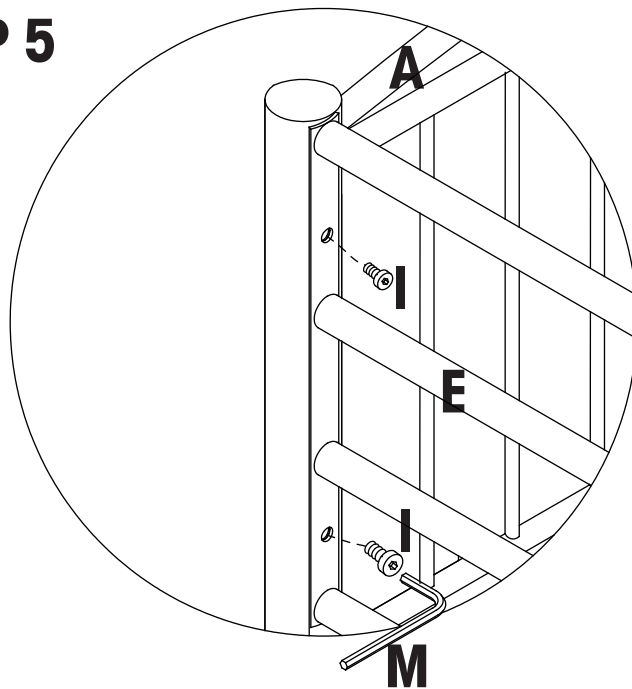

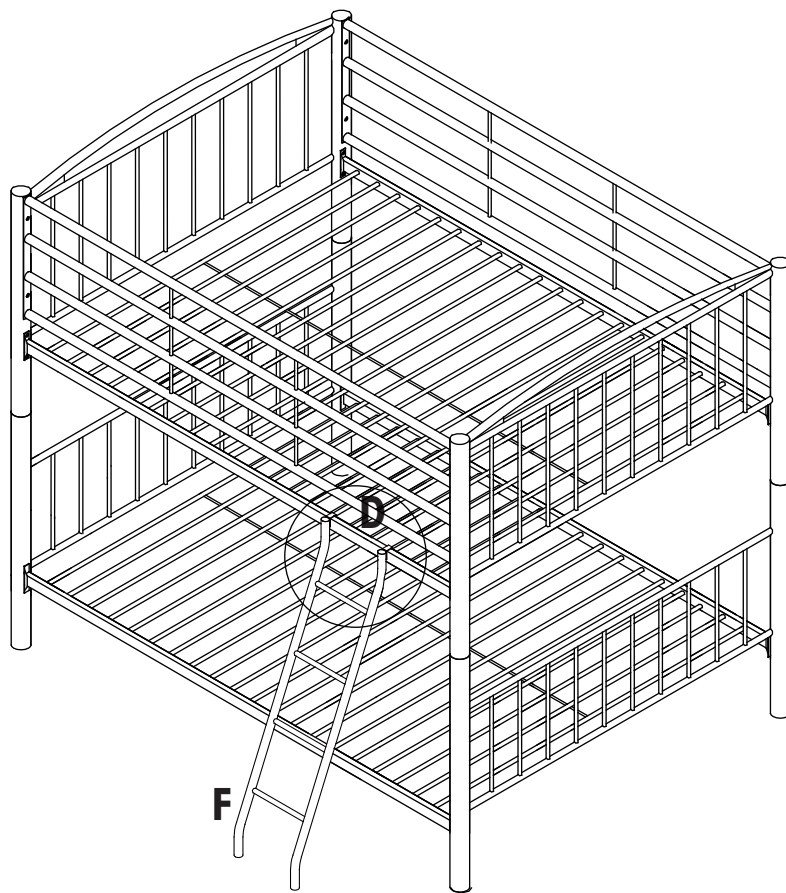

STEP 7

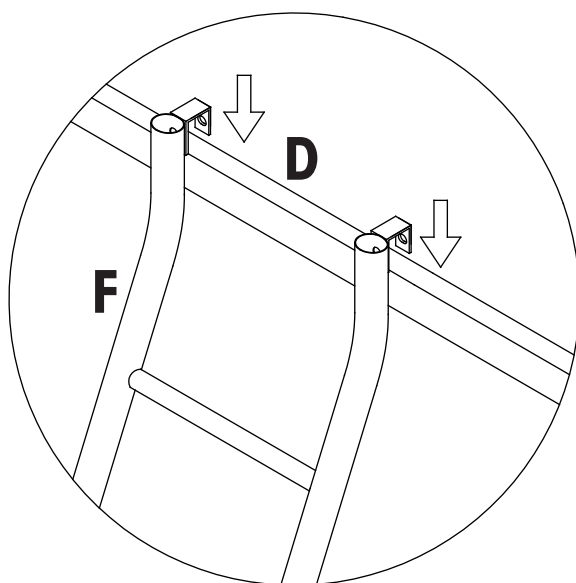

STEP 8

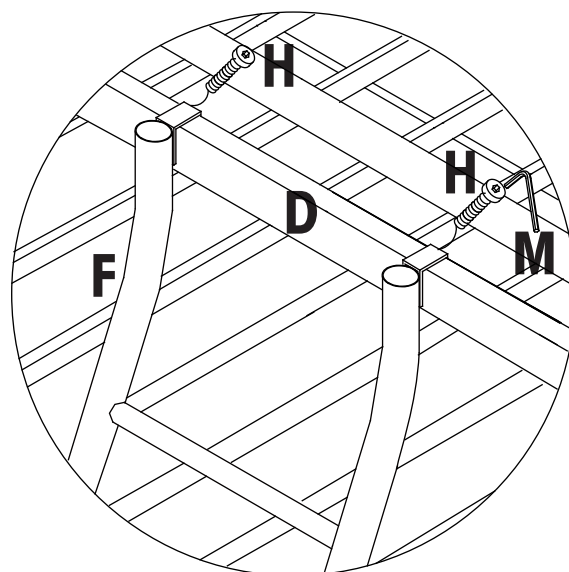

Please reference the following instruction if you want to change from a bunk unit to (2) free-standing beds.

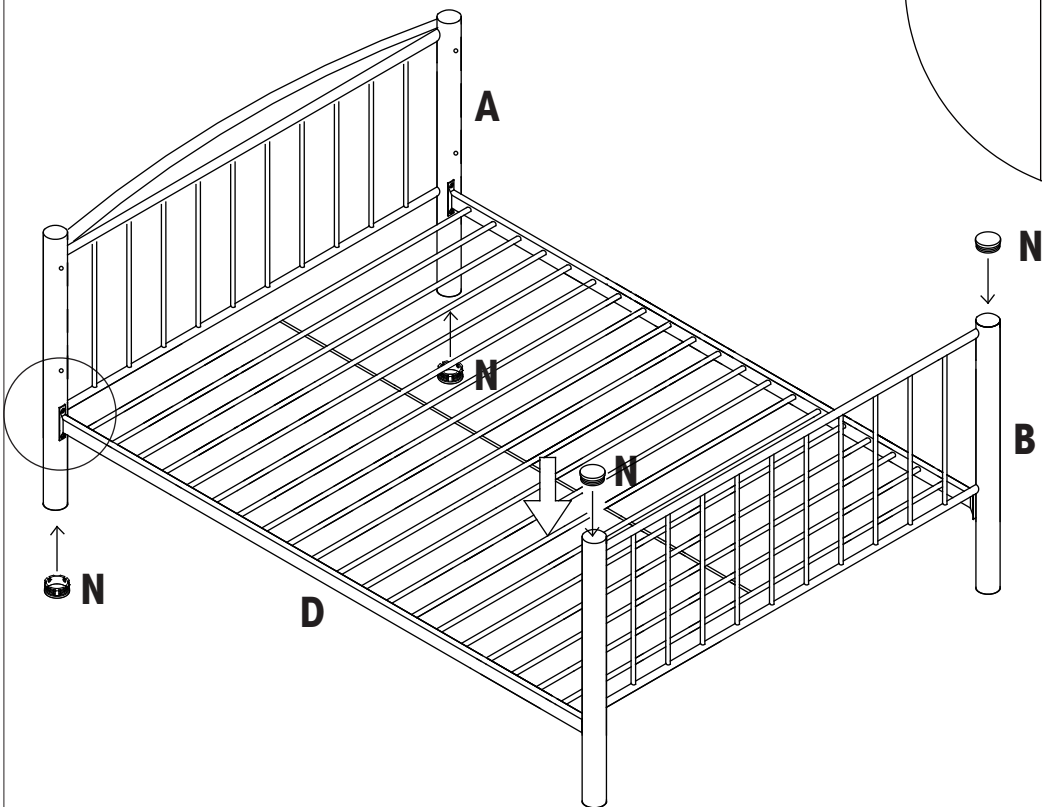
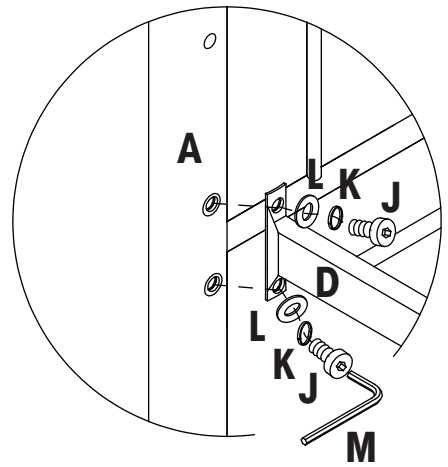
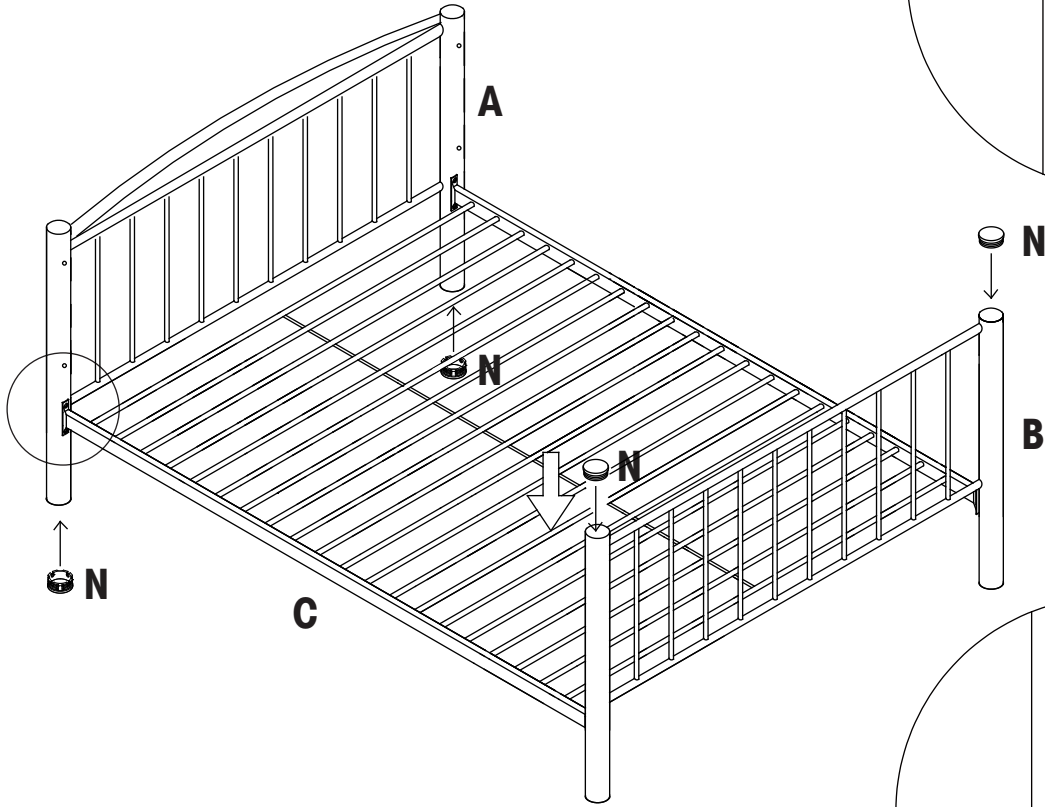
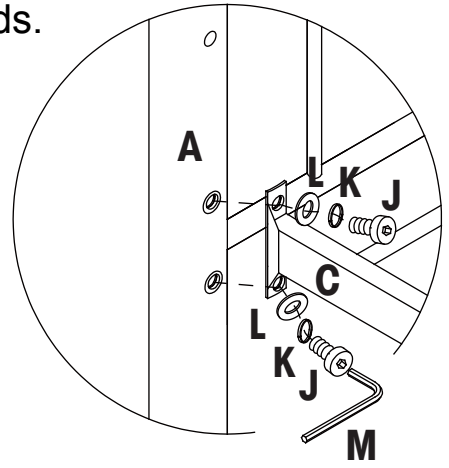



WARNING TO HELP PREVENT SERIOUS OR FATAL INJURIES FROM ENTRAPMENT OR FALLS:

- Follow the information on the warnings appearing on the upper bunk end structure and on the carton. Do not remove warning label from bed.
- Never allow a child under 6 years old on the upper bunk.
- Always use the recommended size mattress or mattress support, or both, to help prevent the likelihood of entrapment or falls.
- Use only a mattress which is 74"- 75" long and 37-1/2- 38-1/2" wide on the bunk.
- Ensure thickness of mattress does not exceed 8" and surface of mattress is at least 5" below upper edge of guardrails.
- Always use guardrails on both long sides of the upper bunk.
- If bunk bed will be placed next to a wall, the guardrail that runs the full length of the bed should be placed against the wall to prevent entrapment between the bed and the wall.
- Prohibit horseplay on or under bed(s) and prohibit jumping on the bed.
- Prohibit more than one person on upper bunk.
- Use ladder for entering and leaving upper bunk.
- Maximum total weight is not to exceed 300 lbs. on the upper bunk.
- Periodically check and ensure that the guardrail, ladder, and other components are in their proper position, free from damage, and that all connectors are tight.
- Do not use substitute parts. Replacement parts, including additional guardrails, may be obtained from our customer service department.
- Use of water or sleep flotation mattresses is prohibited.
- Use of a night light may provide added safety precaution for a child using the upper bunk.

STRANGULATION HAZARD Never attach or hang items to any part of the bunk bed that are not designed for use with the bed; for example, but not limited to, hooks, belts and jump ropes.

DO NOT REMOVE THIS LABEL, KEEP THESE INSTRUCTIONS FOR FUTURE REFERENCE.

MODEL NO. 941-138 PEWTER

938-138 BLACK