

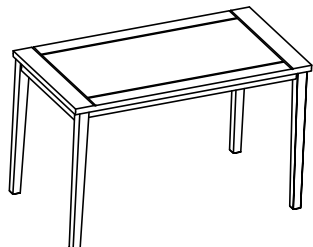

ASSEMBLY INSTRUCTIONS INSTRUCTIONS D'ASSEMBLAGE

ITEM NO: 5103

DINING TABLE / TABLE DE SALLE A MANGER







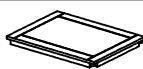

Thank you for purchasing this product. Please take time to read and follow the instructions below. Check that you have all parts and hardware before assembly. Parts apparently missing are often found in the packing materials. If you do not have all the parts listed, have your dealer contact us and they will be sent to you immediately.

⚠ It is recommended to install protective pads under all legs and supports to avoid damage or scratches when placing furniture on a wood floor or other hard surface, and to limit indentation and prevent discoloration if placing on carpet.

Merci d'avoir acheté ce produit. Veuillez lire et suivre les instructions ci-dessous. Vérifiez avant le montage que vous avez toutes les pièces et fixations. Les pièces qui semblent manquer se trouvent souvent dans les matériaux d'emballage. Si vous n'avez pas toutes les pièces de la liste, demandez à votre détaillant et nous vous les enverrons immédiatement.

⚠ Il est recommandé de placer des coussins protecteurs sous tous les pieds et toutes les bases des meubles pour éviter d'endommager ou d'égratigner les planchers en bois ou autres surfaces dures, et pour limiter l'empreinte et empêcher la décoloration quand les meubles reposent sur la moquette.

PARTS LIST /LISTE DE PIECES				HARDWARE LIST /LISTE DE QUINCAILLERIE				
No.	Sketch	Description	Q' ty	No.	Description	Size	Sketch	Q' ty
A		Table Top / Dessus De Table	1pc	1	Flat Washer / Rondelle Plate	5/16" x 19mm		8 pcs
				2	Lock Washer / Rondelle D'arrêt	5/16" x 13mm		8 pcs
B		Leg / Pied	4pcs	3	Nut / Noix	5/16" x 6mm		8 pcs
				4	Open Wrench / Cle	90 x 12mm		1 pc

* ABOVE HARDWARE ARE PACKED IN 5103 FOR ASSEMBLY.

STEP 1 / ETAPE 1

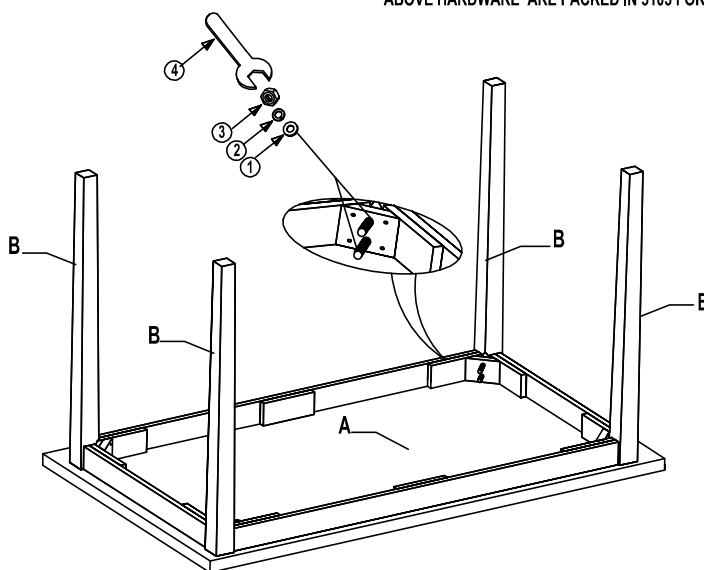

STEP 2 / ETAPE 2

ASSEMBLY COMPLETED/
ASSEMBLAGE COMPLETÉ

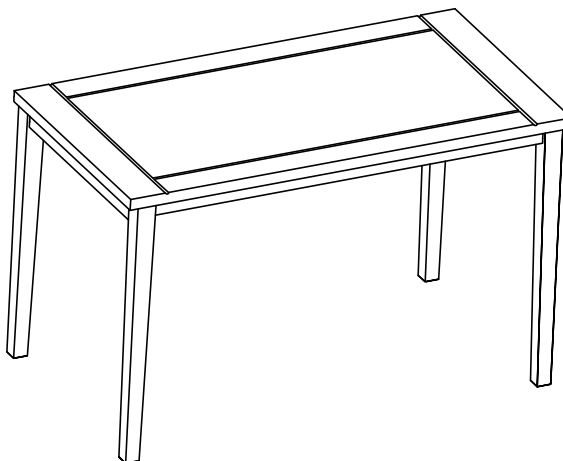

DO NOT TIGHTEN BOLTS UNTIL COMPLETELY ASSEMBLED.
NE PAS SERRER LES BOULONS JUSQU'À CE QUE LE MONTAGE SOIT COMPLETMENT TERMINE.