

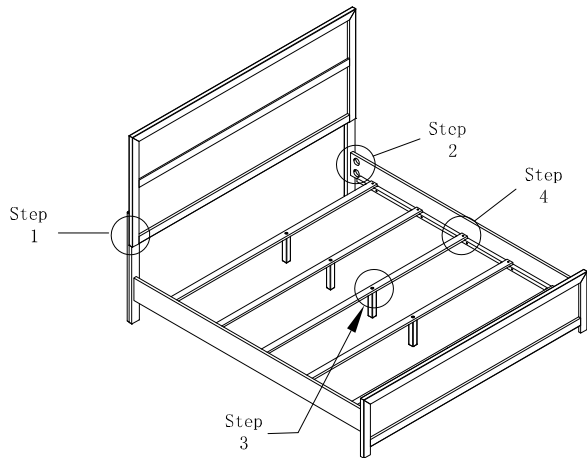





Thank you for purchasing this quality product . Be sure to check all packing material carefully for small parts which may have come loose inside the carton during shipment .Identify and count all parts and compare with the parts list below .

**WARNING:** To avoid alignment issue, please don't tighten the screws unless all legs are adjusted at the same level.

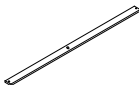
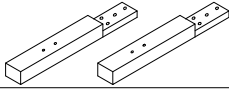

NO	DESCRIPTION	SKETCH	QTY
A	HEADBOARD		1 PC
B	FOOTBOARD		1 PC
C	BED SIDE RAILS		2 PC
D	BED SLATS		5 PC
E	HEADBOARDPOST (L+R)		2 PC
F	SUPPORT LEG		5PC

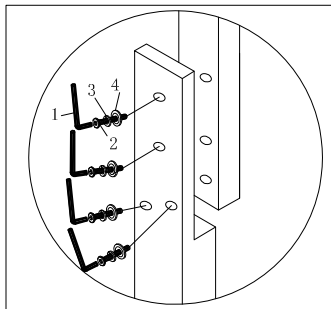

Step 1

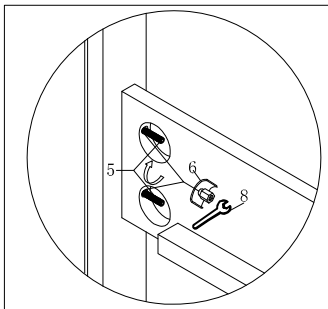

Step 2

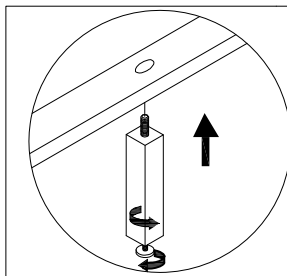



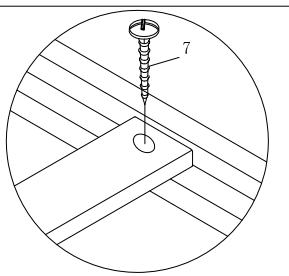



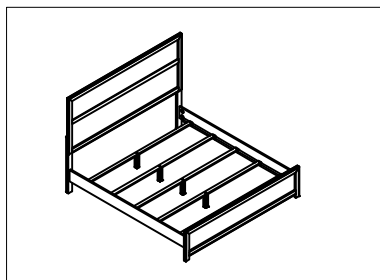

Step 3



Step 4



Step 5

NO	DESCRIPTION	SKETCH	SIZE	QTY
1	Allen Key		5x75x25mm	1 PC
2	Bolt.		ø5/16"x14x45mm	8 PSC
3	Spring Washer		ø5/16"xø14x2mm	8 PSC
4	Flat Washer		ø5/16"xø19x2mm	8 PSC
5	threadedrod		ø5/16"x80mm	8 PSC
6	type nut		ø5/16"	8 PSC
7	Screw		#8x32mm	10 PSC
8	wrench			1 PC