





ASSEMBLY INSTRUCTIONS

**MODEL : C8170A
KING (4+8)**



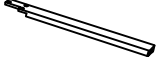

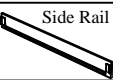

(Box 1)
BOX OF HEADBOARD & FOOTBOARD

No	ITEM	Qty
A	Headboard 	1 pc
B	Footboard 	1 pc
C	Headboard Leg (L/R) 	2 pcs
D	Bed Slats 	4 pcs
E	Bed Slats Support 	8 pcs

(Box 2)
BOX OF SIDE RAIL

No	ITEM	Qty
F	Side Rail 	2 pcs

(Box 1)
HARDWARE LIST

No	ITEM	Qty
1	Csk M4 x 32mm 	8 pcs
2	JCBC M6 x 30mm 	6 pcs
3	SPRING WASHER 1/4" Rbw 	6 pcs
4	Flat Washer 1/4" ID x 13mm OD Blk 	6 pcs
5	ALLEN KEY m4x65mm Blk 	1 pc
6	ALLEN KEY m5x65mm Blk 	1 pc

STEP 1 : Attach Head Board Leg (C) to Head Board (A) as shown using JCBC BOLT (2) with Spring Washer (3), Flat washer (4) and securing with ALLEN KEY (5) .

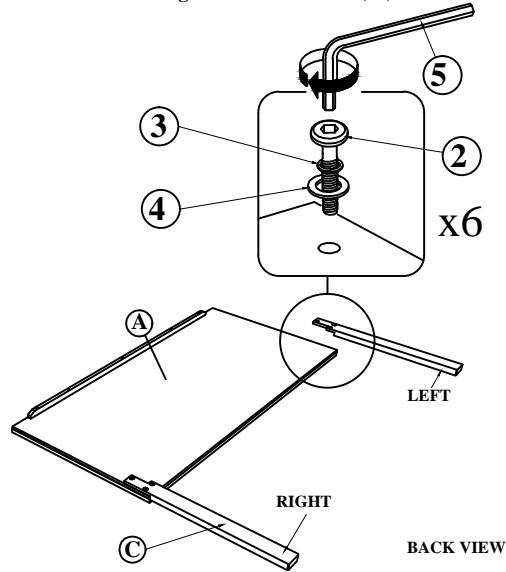

STEP 2 : Hook SIDE RAIL (F) TO HEAD BOARD (A) closely and push down to fit. repeat step 2 with other end of rail to hook onto FOOTBOARD (B).

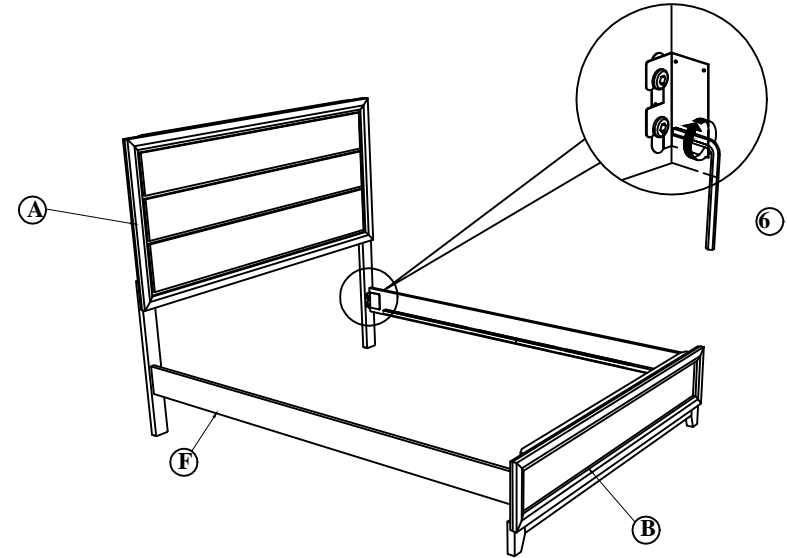

STEP 3 : Tighten the 4 Corner with Allen Key (6). Fix the Bed Slat Support Leg (E), to Bed Slat (D) as shown . Install the bed slat (D) to side rail (F) and tighten with Csk Screw (1) as per diagram shown. (NOTE: THE SETUP MUST DONE AT THE DECIDED LOCATION FOR THE BED TO OBTAIN PERFECT STABILITY)

STEP 3.2 :

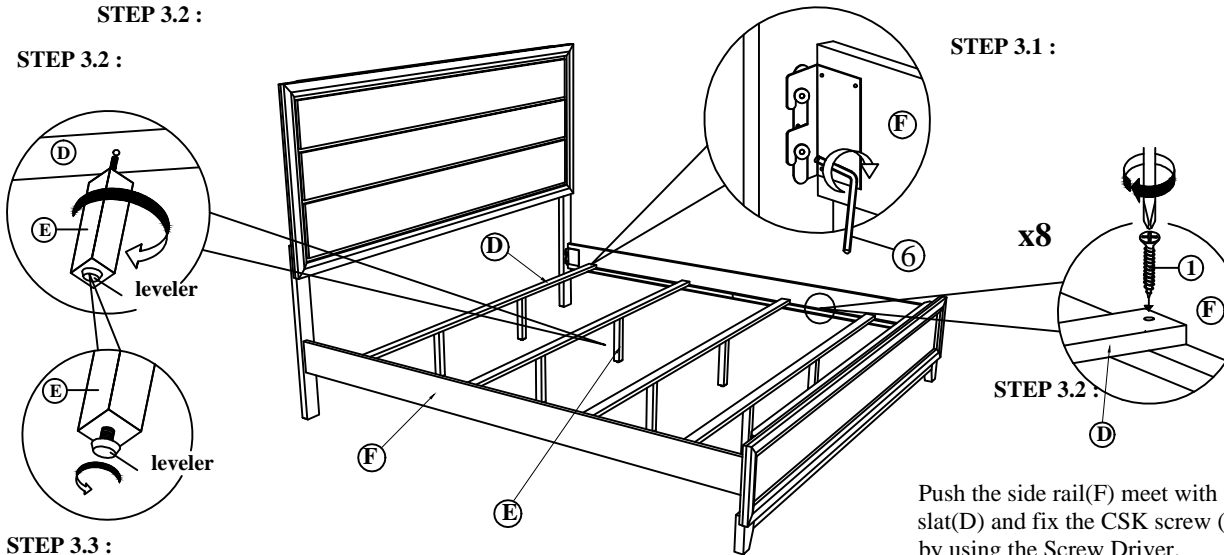





Push the side rail(F) meet with wooden slat(D) and fix the CSK screw (1) by using the Screw Driver.

NOTE : MUST TIGHTEN SCREWS PERIODCALLY WITH USE SCREW WILL BECOME LOOSE CHECK TIGHTNESS OF ALL SCREW EVERY 6-8 WEEKS.

INSTRUCTIONS D'ASSEMBLAGE

MODÈLE : C8170A
TRES. GRAND LIT (4+8)

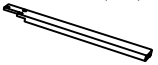



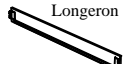

(Cart. 1)
CARTON DE TÊTE & PIED DE LIT

N°	PIECE	Qté
A	Tête de lit 	1 pce
B	Pied de lit 	1 pce
C	Pied de TDL (D/G) 	2 pces
D	Lattes 	4 pcs
E	Soutien de Latte 	8 pces

(Cart. 2)
BOITE DE CÔTÉ RAIL

N°	PIECE	Qté
F	Longeron 	2 pces

(Cart. 1)
QUINCAILLERIE

N°	PIECE	Qté
1	Vis Csk M4 x 32mm 	8 pces
2	BOULON JCBC M6 x 30mm 	6 pces
3	Rondelle A Ressort 1/4" Rbw 	6 pcs
4	Rondelle Plate 1/4" ID x 13mm OD Nre 	6 pces
5	CLÉ ALLEN m4 x 65mm NRE 	1 pce
6	CLÉ ALLEN m5 x 65mm NRE 	1 pce

ETAPE 1 : Attacher les Pieds de la TDL (C) à la Tête de lit (A) comme indiqué avec des BOULONS JCBC (2) des Rondelles à ressort (3), des Rondelles plates (4) en utilisant la CLE ALLEN (5).

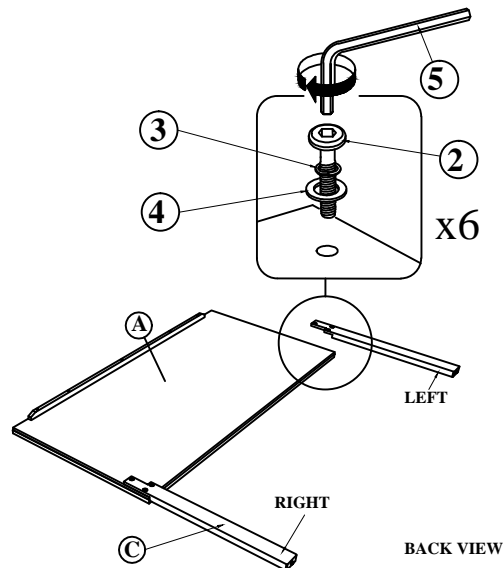

ETAPE 2 : Accrochez le RAIL LATÉRAL (F) À LA PLANCHE DE DIRECTION (A) et poussez-le pour l'ajuster. répétez l'étape 2 avec l'autre extrémité du rail pour accrocher le MARCHE-PIED (B).

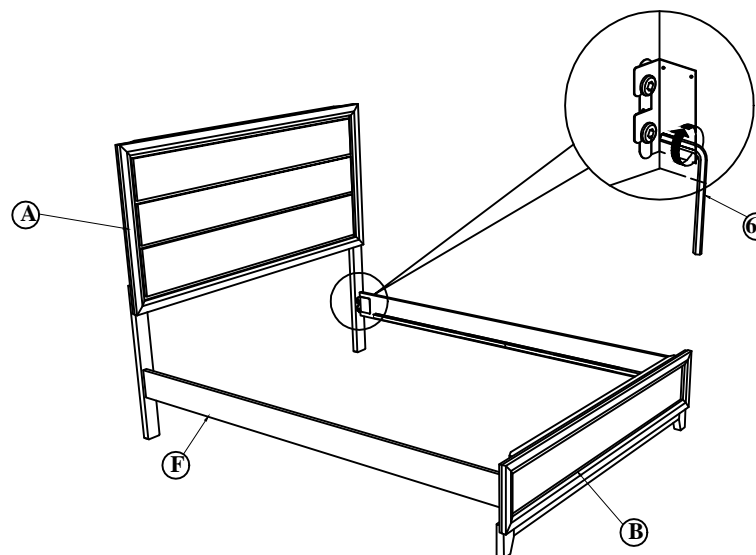

ETAPE 3 : Serrer les 4 coin avec une clé Allen (6). Fixer la jambe de lattes de lit (E), à double Barrette (D) comme indiqué . Installer le lit de lamelles (D) à l'autre rail (F) et serrer avec la vis Csk (1) au schéma indiqué. (Remarque : L'INSTALLATION DOIT ÊTRE FAITE À L'ENDROIT DÉCIDÉ POUR LE LIT D'OBTENIR UNE STABILITÉ PARFAITE)

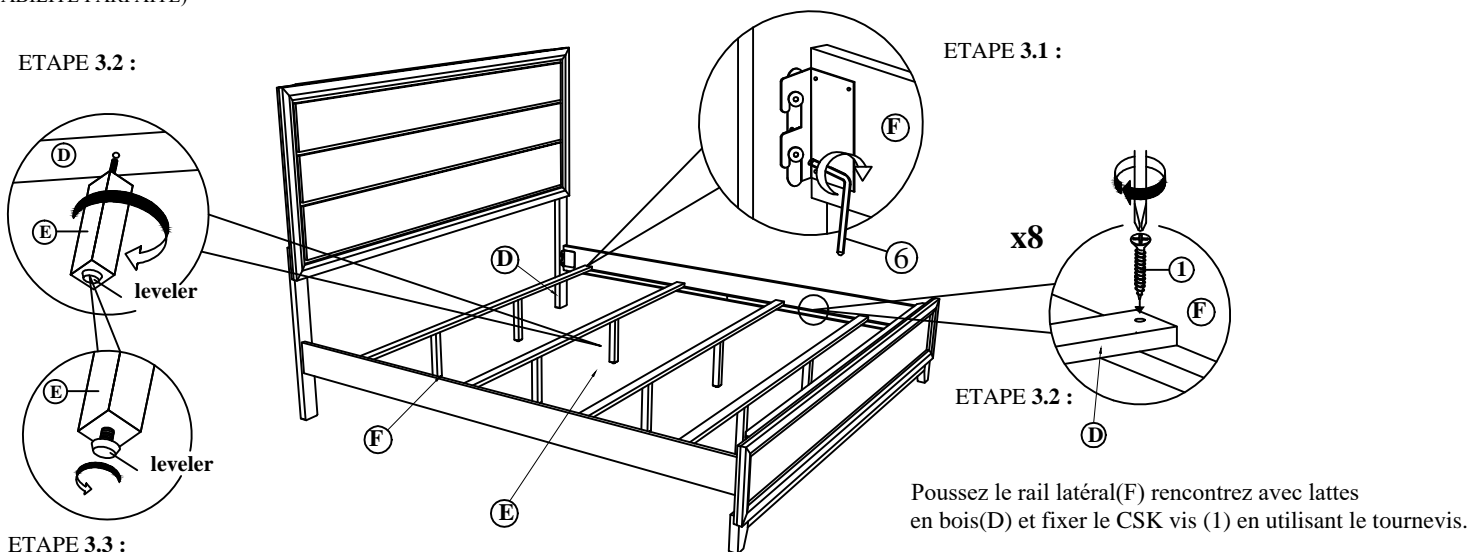

REMARQUE: SERRER LES VIS PERIODEMENT AVEC LA VIS D'UTILISATION. DEVENIR LIBRE VÉRIFIER L'ÉTANCHÉITÉ DE TOUTE LA VIS TOUTES LES 6 À 8 SEMAINES.