







# Assembly Instruction

6067-CUR Hutch

**WARNING :** To avoid alignment issue ,please don't tighten the screws unless all legs are adjusted at the same level .

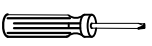
HARDWARE LIST				QTY'
A		Allen bolt	Ø1/4"x20x1"	2
		Lock washer	Ø1/4"x12x2mm	
		Flat washer	Ø1/4"x19x2mm	
B		Allen key	4mm	1
C		Metal pin		16
D		Furniture tipping restraint		1
<b>TOOLS REQUIRED (NOT PROVIDED):</b> <b>PHILLIPS SCREW DRIVER</b>				

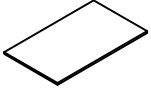
PART LIST			QTY'
1	LOWER CABINET		1
2	GLASS		4

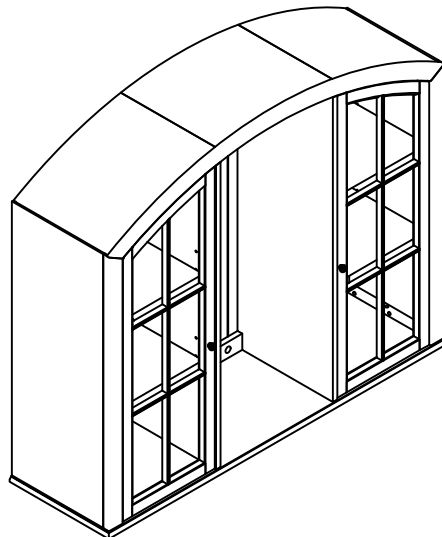

**ASSEMBLY COMPLETED**

# Assembly Instruction

6067-CUR Hutch

**\*\*\*Caution: Please read all instructions carefully before starting the assembly process. These parts are cumbersome and heavy. Therefore, two people are recommended in order to prevent personal injury and ensure the parts are not damaged during the assembly.**

## STEP 1

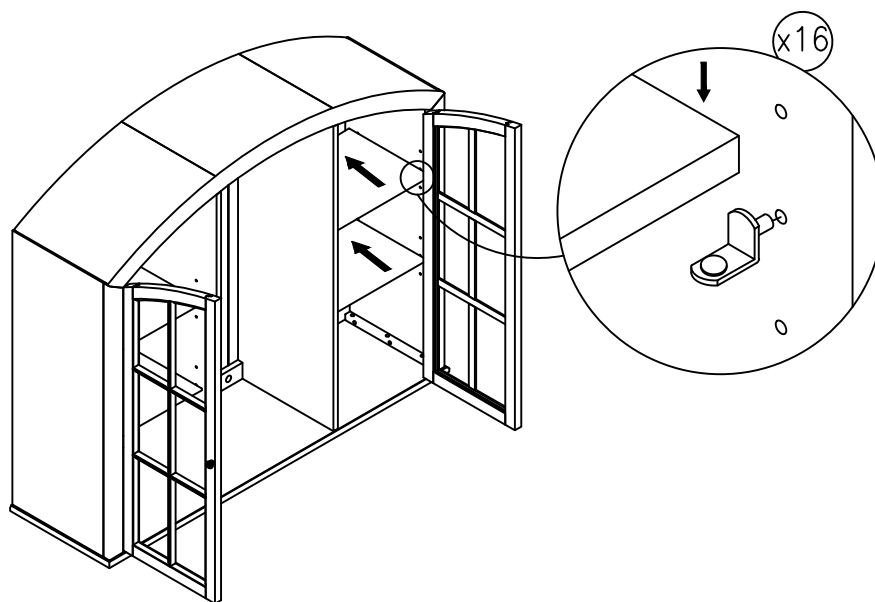

## STEP 2

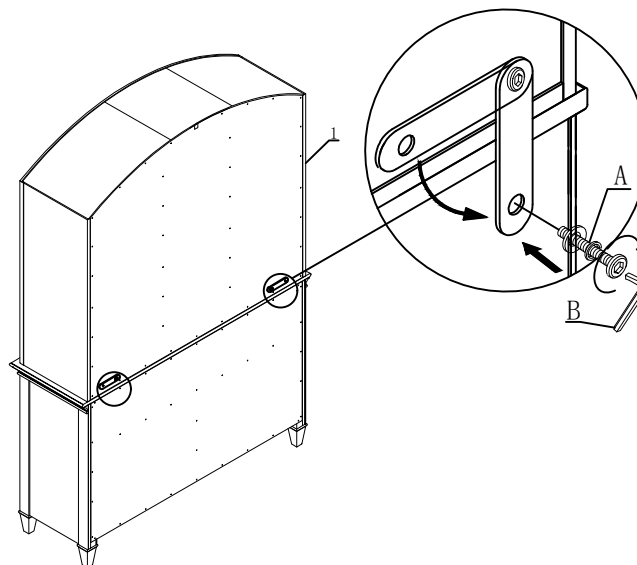

## Assembly Instruction

6067-CUR Hutch

**\*\*\*Caution: Please read all instructions carefully before starting the assembly process. These parts are cumbersome and heavy. Therefore, two people are recommended in order to prevent personal injury and ensure the parts are not damaged during the assembly.**

### STEP 3

