

SPECIFICATIONS

AMALFI

Murano Collection



Shown in Bianco

TOP VIEW

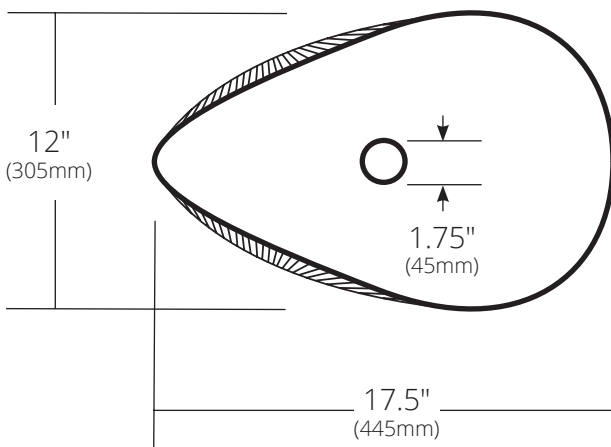

SIDE VIEW

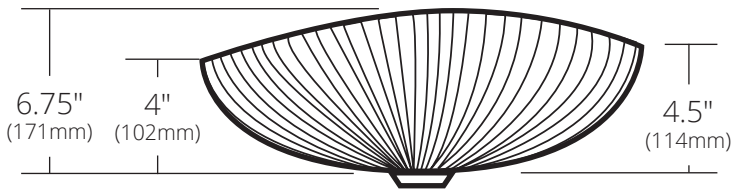

- MG1912-AE Abalone
- MG1912-BO Bianco
- MG1912-SE Shoreline

PRODUCT DETAILS

- 17.5" x 12" x 6.75" OD
(445mm x 305mm x 171mm)
- 17" x 11.5" x 6.5" ID
(432mm x 292mm x 165mm)
- Handcrafted, Certified Murano Glass
- 1.75" (45mm) drain opening

INSTALLATION

- Vessel
- **Note:** 3.5" vessel cutout required for countertop (*larger than standard*)

COORDINATING PRODUCTS

- Drains : DR120, DR130 or DR150
- Vanity tops with vessel cutout

STANDARDS COMPLIANCE

- UPC/cUPC compliant

IMPORTANT

Due to the handcrafted nature of this product, it will vary in finish, texture, and other details. Dimensions may vary up to ½" (13mm).