

Furo Walk-in

The product in other colour variants can be found on p. 78

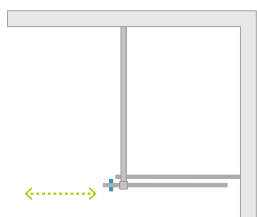

Profile finish:

Glossy:

Matte:



01 Chrome 09 Gold 54 Black

Brushed:



91 Nickel 99 Gold 92 GunMetal 93 Copper



Furo Walk-in + Kyntos F Black

In the article number, the symbol "XX" should be replaced with the symbol of the selected colour: 09, 91, 92, 93, 99

Shower enclosure set consists of 2 parts: shower door and front wall. Please specify all the article numbers when making an order.

Model	Nazwa elementu	TRANSPARENT GLASS		
		profile finish: CHROME Art. No.	profile finish: BLACK Art. No.	Art. No.
Walk-in 80 L	Door 438 L	10106438-01-01L	10106438-54-01L	10106438-XX-01L
	Front wall 394	10110394-01-01	10110394-01-01	10110394-01-01
Walk-in 80 R	Door 438 R	10106438-01-01R	10106438-54-01R	10106438-XX-01R
	Front wall 394	10110394-01-01	10110394-01-01	10110394-01-01
Walk-in 90 L	Door 488 L	10106488-01-01L	10106488-54-01L	10106488-XX-01L
	Front wall 444	10110444-01-01	10110444-01-01	10110444-01-01
Walk-in 90 R	Door 488 R	10106488-01-01R	10106488-54-01R	10106488-XX-01R
	Front wall 444	10110444-01-01	10110444-01-01	10110444-01-01
Walk-in 100 L	Door 538 L	10106538-01-01L	10106538-54-01L	10106538-XX-01L
	Front wall 494	10110494-01-01	10110494-01-01	10110494-01-01
Walk-in 100 R	Door 538 R	10106538-01-01R	10106538-54-01R	10106538-XX-01R
	Front wall 494	10110494-01-01	10110494-01-01	10110494-01-01
Walk-in 110 L	Door 588 L	10106588-01-01L	10106588-54-01L	10106588-XX-01L
	Front wall 544	10110544-01-01	10110544-01-01	10110544-01-01
Walk-in 110 R	Door 588 R	10106588-01-01R	10106588-54-01R	10106588-XX-01R
	Front wall 544	10110544-01-01	10110544-01-01	10110544-01-01
Walk-in 120 L	Door 638 L	10106638-01-01L	10106638-54-01L	10106638-XX-01L
	Front wall 594	10110594-01-01	10110594-01-01	10110594-01-01
Walk-in 120 R	Door 638 R	10106638-01-01R	10106638-54-01R	10106638-XX-01R
	Front wall 594	10110594-01-01	10110594-01-01	10110594-01-01
Walk-in 130 L	Door 688 L	10106688-01-01L	10106688-54-01L	10106688-XX-01L
	Front wall 644	10110644-01-01	10110644-01-01	10110644-01-01
Walk-in 130 R	Door 688 R	10106688-01-01R	10106688-54-01R	10106688-XX-01R
	Front wall 644	10110644-01-01	10110644-01-01	10110644-01-01
Walk-in 140 L	Door 738 L	10106738-01-01L	10106738-54-01L	10106738-XX-01L
	Front wall 694	10110694-01-01	10110694-01-01	10110694-01-01
Walk-in 140 R	Door 738 R	10106738-01-01R	10106738-54-01R	10106738-XX-01R
	Front wall 694	10110694-01-01	10110694-01-01	10110694-01-01
Walk-in 150 L	Door 788 L	10106788-01-01L	10106788-54-01L	10106788-XX-01L
	Front wall 744	10110744-01-01	10110744-01-01	10110744-01-01
Walk-in 150 R	Door 788 R	10106788-01-01R	10106788-54-01R	10106788-XX-01R
	Front wall 744	10110744-01-01	10110744-01-01	10110744-01-01
Walk-in 160 L	Door 838 L	10106838-01-01L	10106838-54-01L	10106838-XX-01L
	Front wall 794	10110794-01-01	10110794-01-01	10110794-01-01
Walk-in 160 R	Door 838 R	10106838-01-01R	10106838-54-01R	10106838-XX-01R
	Front wall 794	10110794-01-01	10110794-01-01	10110794-01-01

TECHNICAL DRAWINGS

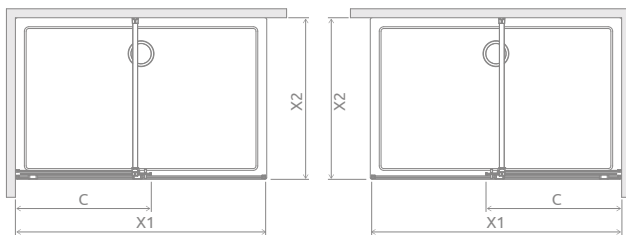
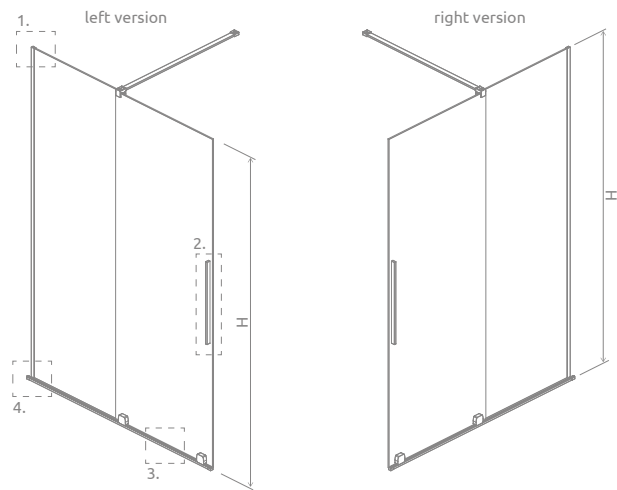

When installed on a shower tray – the minimum width of the edge of the shower tray is 43 mm, and its slope max 1 mm.

Model	X1	X2	C	H
Walk-in 80	790-800	max 1200	453-463	2000
Walk-in 90	890-900	max 1200	503-513	2000
Walk-in 100	990-1000	max 1200	553-563	2000
Walk-in 110	1090-1100	max 1200	603-613	2000
Walk-in 120	1190-1200	max 1200	653-663	2000
Walk-in 130	1290-1300	max 1200	703-713	2000
Walk-in 140	1390-1400	max 1200	753-763	2000
Walk-in 150	1490-1500	max 1200	803-813	2000
Walk-in 160	1590-1600	max 1200	853-863	2000

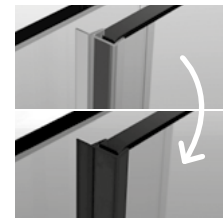
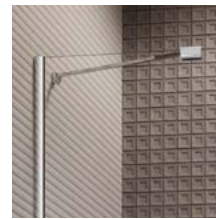
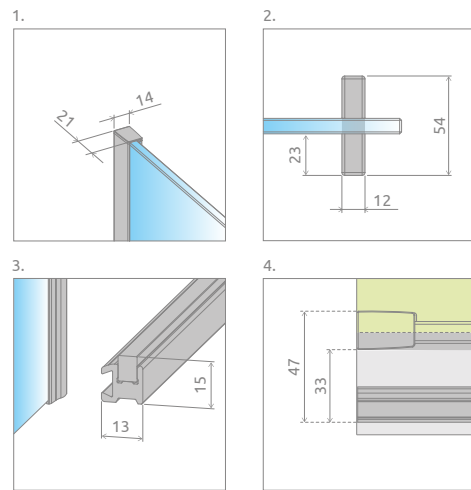

If the width of the front of the cabin ($X \leq 1400$), it is possible to change the perpendicular support bar to the corner one. This option should be clearly stated in the order.

There is a possibility of a paid replacement of transparent gaskets (vertical and horizontal) for black gaskets. This option should be clearly stated in the order.



It is possible to make the product with a railing handle¹⁾ which also functions as a towel hanger.



It is possible to extend the entrance by 30 mm by replacing the vertical handle with a round one²⁾. Please contact the non-standard cabins department.

ADDITIONAL OPTIONS

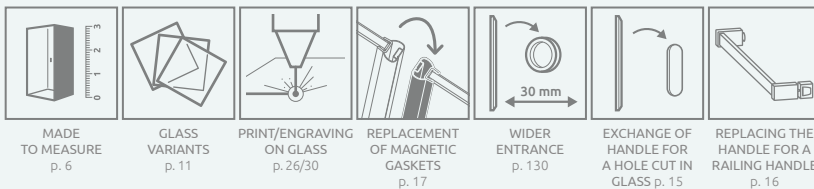

Possibility of replacing the standard handle with a 35x120 mm hole cut in the glass pane.

NAVIGATION

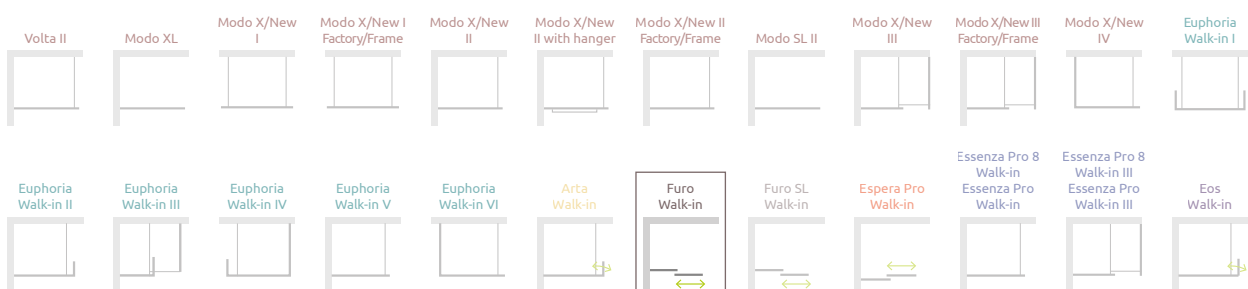

¹⁾ only chrome, gold and black colour ²⁾ only chrome and black colour
Dimensions are given in mm.