

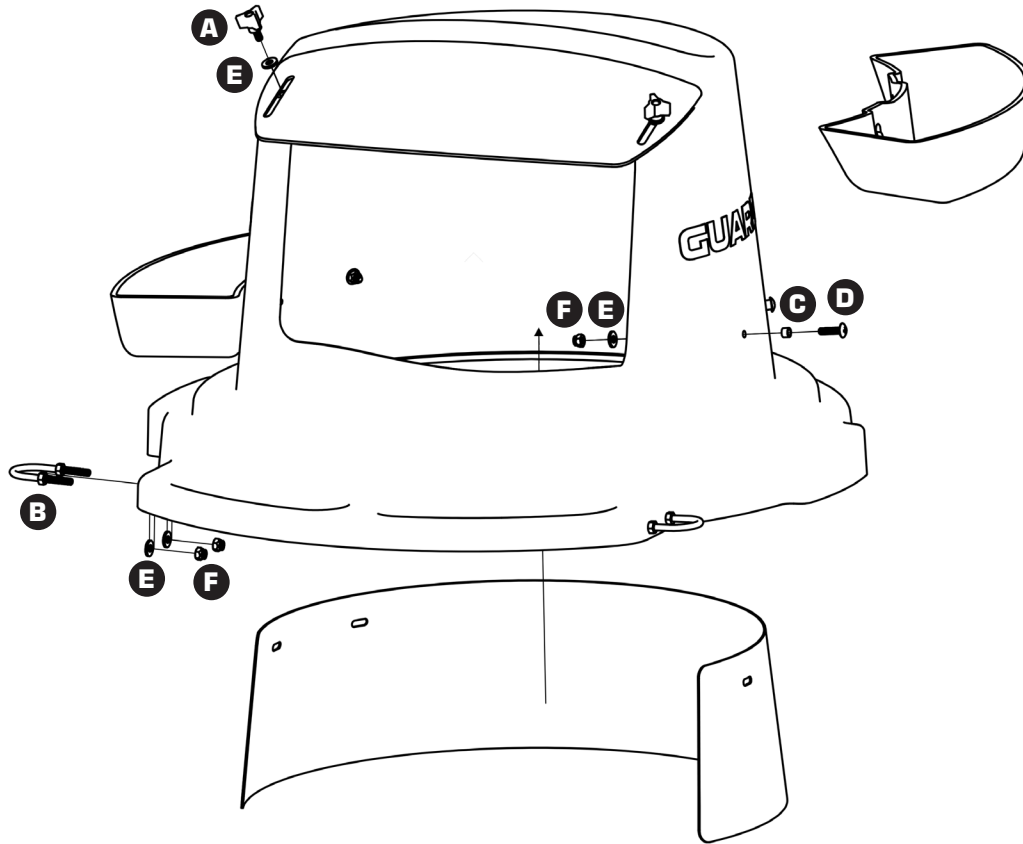





GUARDAIR®

Chip Collector Lid Assembly Instructions

Part Number CC250



Parts List		
	A	(2) Thumb Screw
	B	(2) U-bolt
	C	(4) Spacer
	D	(4) Screw
	E	(10) Washer
	F	(8) Nut

Step 1: Install spray shield using thumb screw (A) and washer (E).

Step 2: Install U-bolts (B), use washer (E) and nut (F) to fasten.

Step 3: Align drip shield on inside of chip collector.

Step 4: Fasten one side of drip shield using spacer (C), screw (D), washer (E), and nut (F). Arrange hardware as shown.

Step 5: While pressing drip shield to back wall of Chip Collector, fasten other side of drip shield. Ensure snug connection between back wall and drip shield.

Step 6: Mount side bin onto standoffs using keyhole, and press downward to snap into place.