

WALTON
It's our product

androidtv

User Manual

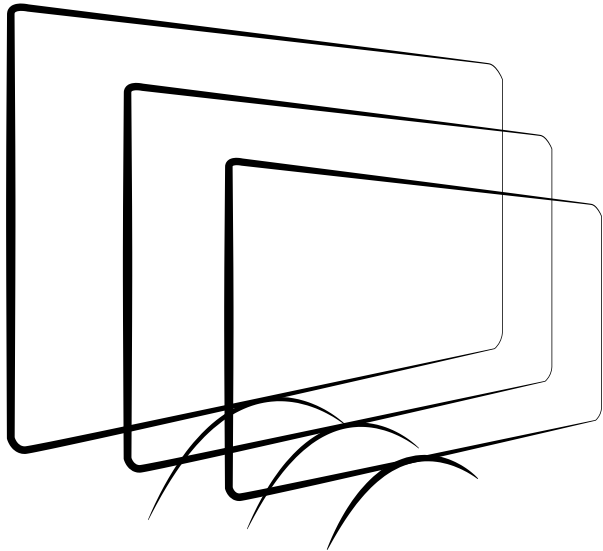

W32D120GE

Supplied By Shomar Ltd Dublin

Contact us service@shomar.ie

To obtain the best performance and safety, please read this manual carefully.
Please keep this manual for future reference.

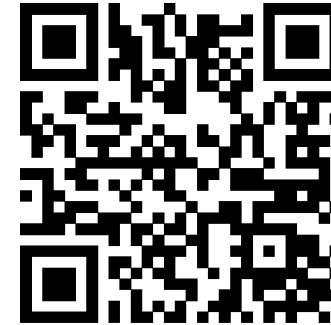

Scan QR code to access EPREL Data Base.

CONTENTS

WARNING AND PRECAUTIONS	4-6
BRIEF INTRODUCTION	7
EXTERNAL SCHEMATIC AND INSTALLATION	8-9
Back Panel	8
Front Panel	9
Antenna/Cable Connection	9
REMOTE CONTROLLER	11
BASIC OPERATION	11-37
SOURCE	11
Initial Setup	11-19
HOME Screen	20
Settings	21
Picture	22
Sound	23
Channel	24
Antenna	24-25
Cable	26
Satellite	26-27
CI Card Setup	27
Date and Time	27-28
Timer	28
Network	29
Other Information	29-37
MULTIMEDIA OPERATION	38-42
Add and use of Multimedia Player	38
Video	39
Photo	40
Music	41
Text	41
Gentle Reminder When Using USB Player	42
BUILT-IN APPS	43
TROUBLESHOOTING	44-45
SPECIFICATIONS	46

WARNING AND PRECAUTIONS

Read all of the instructions before operating the set. Keep these instructions well for later use.

WARNING

- ❖ Only use attachment/accessories specified or provided by manufacturer (such as the exclusive supply adapter, battery etc.).
- ❖ Please refer the information on exterior back enclosure for electrical and safety information before installing or operating the apparatus.
- ❖ To reduce the risk of fire or electric shock, do not expose this apparatus to rain or moisture.
- ❖ The ventilator should not be impeded by covering the ventilation openings with items such as newspaper, table cloths, curtains, etc.
- ❖ The apparatus shall not be exposed to dripping or splashing and so that no object filled with liquids, such as vases, shall not be placed on the apparatus.
- ❖ For the terminals marked with symbol of ⚡ may be of sufficient magnitude to constitute a risk of electric shock. The external wiring connected to the terminals requires installation by an instructed person or the use of ready-made leads or cords.
- ❖ To prevent injury, this apparatus must be securely attached to the floor/wall in accordance with the installation instructions.
- ❖ Danger of explosion if battery is incorrectly replaced. Replace only with the same or equivalent type.
- ❖ The battery (battery or batteries or battery pack) shall not be exposed to excessive heat such as sunshine, fire or light.
- ❖ Excessive sound pressure from earphones and headphones can cause hearing loss.
- ❖ Listening to music at high volume levels and for an extended duration can cause hearing damage. In order to reduce the risk of damage for hearing, one should reduce the volume to a safe, comfortable level, and reduce the amount of time of listening at high levels.
- ❖ The main plug is used as disconnected device, the disconnected device shall remain readily operable.
- ❖ When not in use and during movement, please take care of the power cord set, e.g. tie up the power cord set with cable tie or something like that. It shall be free from sharp edges and the like can cause abrasion of the power cord set. When put into use again, please make sure the power cord set being not damaged. If any damage found, please look for the service person to replace the power cord set specified by the manufacturer or have the same characteristics as the original one.
- ❖ Explanation of symbol, marking, signal lamp or similar means indicate that apparatus is completely disconnected from the mains.
- ❖ Attention should be drawn to environmental aspects of battery disposal.
- ❖ No naked flame sources, such as lighted candles, should be placed on the apparatus.
- ❖ ⚠ To prevent the spread of fire, keep candles or other open flames away from this product at all times.
- ❖ Each USB terminal shall be loaded with 500mA under normal operation.

WARNING AND PRECAUTIONS

Operating Environment

- ❖ Do not install this equipment in a confined space such as book case or similar unit
- ❖ Do not use the set near damp and cold areas; protect the set from overheating
- ❖ Keep away from direct sunlight
- ❖ Do not use the set near dust place
- ❖ Do not attach candle to accessible open area, to avoid flammable foreign material from entering the TV

Precaution for Using Remote Control

- ❖ Use the remote control by pointing it towards IR sensor; anything in between IR sensor and remote control will interrupt the operation
- ❖ Do not make remote control vibrate violently. Also do not splash liquid on the remote control, also do not put the remote control in high humidity place.
- ❖ Do not place remote control under direct sunlight which will cause deformation of the unit
- ❖ When the remote sensor is under direct sunlight or strong lighting, remote control will not work. If so, please change the lighting or TV's position, or operate the remote control closer to TV's position.

Precaution for Using Battery

Improper use of battery will cause leakage. So, please do as the following methods and use carefully.

- ❖ Please note batteries' polarity to avoid Short Circuit
- ❖ Do not use different types (like Alkaline and Manganese batteries) of batteries together
- ❖ If battery voltage is insufficient which affect the use range; please replace the batteries. Remove the batteries from remote control if you don't intend to use it for a long time.
- ❖ Do not put batteries into fire and charge or decompose the battery
- ❖ Please dispose batteries abiding by relevant environmental protection regulation

Installation of Remote Controller Battery

- ❖ Place 2 AAA size batteries to remote controller battery compartment
- ❖ Make sure that the polarity is correct



a. Open



b. Make sure correct polarity



c. Close

WARNING AND PRECAUTIONS

WARNING

Never place a television set in an unstable location. A television set may fall causing severe personal injury or death. Many injuries, particularly to children can be avoided by taking simple precautions such as:

- ❖ Using cabinets or stands recommended by manufacturer of the television
- ❖ Only using furniture that can safely support the television.
- ❖ Ensuring the television is not overhanging the edge of the supporting furniture.
- ❖ Not placing the television on a tall furniture (like bookcases or cupboards) without anchoring both the furniture and television to a suitable support.
- ❖ Not standing the television on cloth or other materials placed between the television and the support.
- ❖ Educating children about the danger of climbing the furniture to reach the television or its control.
- ❖ The apparatus should be provided with a restraining device such as a fixing point to facilitate restraining the apparatus from toppling forward.

If your existing television set is being retained and relocated, the same considerations as above should be applied.

WEEE Directive

 Correct disposal of this product. This marking indicates that this product should not be disposed with other household wastes throughout the EU. To prevent possible harm to the environment or human health from uncontrolled waste disposal, recycle it responsibly to promote the sustainable reuse of material resources. To return your used device, please use the return and collection systems or contact the retailer where the product was purchased. They can take this product for environmental safe recycling.

Positioning the TV Set

- ❖ Install display on solid horizontal surface such as table or desk. For ventilation, leave a space of at least 10cm free all around the set. To prevent any fault and unsafe situations, please do not place any object on top of the set. This apparatus can be used in tropical and/or moderate climate.
- ❖ Fixing the rear of enclosure to wall.

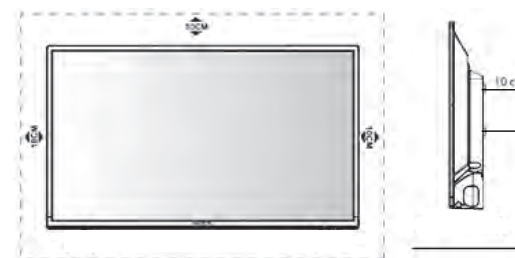

* Images are for illustration only

BRIEF INTRODUCTION

Thanks for your purchase of digital high-definition Walton Smart LED TV! This product with diverse functions is designed to fulfill the optimum requirements from commercial, industrial and household uses. This Smart LED television possesses the functionality of both ATV and DTV. It features advanced picture performance, smaller in size and lighter in weight; meanwhile consumes less power and emits no radiation. The new generation Smart LED TV provides you with comfortable, safe and environmental protection feeling. Some description could be different based on different models.

TV FUNCTIONS

- ❖ Auto and Manual Tuning
- ❖ Supports PAL,SECAM color system and BG,DK,I, NICAM sound system
- ❖ Supports DVB-T/T2/C/S/S2
- ❖ AV and HDMI inputs available
- ❖ Common Interface+ slot available
- ❖ Selectable Color temperature
- ❖ Full function Infra-red remote control
- ❖ Sleep Timer and Program Recall Shortcut
- ❖ Netflix, You Tube, Net range and USB drive shortcut

FEATURES

- ❖ Embedded digital color gain control circuit, provides better brightness and reality
- ❖ Black/White Level stretch circuit
- ❖ Auto signal format recognition, plug and play
- ❖ High class LCD screen features; high contrast, high brightness, wide viewing angle and fast response
- ❖ Supports CI+ card
- ❖ Supports HDMI input
- ❖ Lower power consumption in standby mode to save energy
- ❖ High integrated digital processor chip

EXTERNAL SCHEMATIC AND INSTALLATION

Back Panel

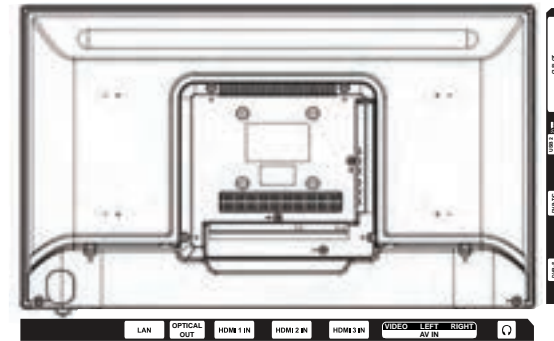

LAN: Ethernet/LAN input from Router to TV

Optical Out/Coax Out: Digital Audio Output from TV

HDMI1/HDMI2/HDMI3: Connect HDMI input signal from signal source such as DVD

AV In: Connect Audio and Video input signal from source such as DVD

Audio Out: Audio Output from TV through Earphone

RF In: Connect Analog/ATV signal or Digital/ DVB-T/T2 or DVB-C signal

SAT: Connect DVB-S/S2 Signal

USB: USB support multimedia playback and software upgrade

CI Slot: Connect CI Card

* Images are for illustration only

EXTERNAL SCHEMATIC AND INSTALLATION

Front Panel

Power button, Volume Up/Down, Channel Up/Down

1. Power button

Turns the TV on or standby. (Note: for some models, the button turns the TV on or off)

2. Volume Up/Down

Increase/decreases the volume. They act like the left/right direction buttons on the remote and adjust menu controls.

3. Channel Up/Down

Scans Up/down through the channel list. They act like the up/down direction buttons on the remote and adjust menu controls.

Antenna/Cable Connection

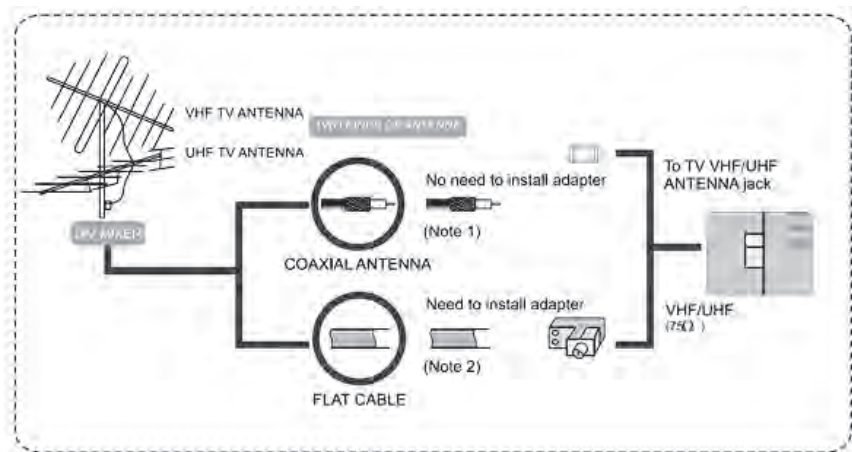

a. Connect the Plug of the antenna cable or CATV cable to the cable (not provided with this unit), then connect to the antenna input of this unit for best reception.

b. If the antenna cable in your home is other than the above two or you have problems in installing the antenna, please contact your dealer.

Notes:

a. Current outdoor antenna or cable TV use 75 OHM coaxial antenna cable. For better reception suggest this kind of antenna cable

b. Flat cable or indoor antenna are old designed, the reception may not be good enough

REMOTE CONTROLLER

Using The REMOTE CONTROLLER

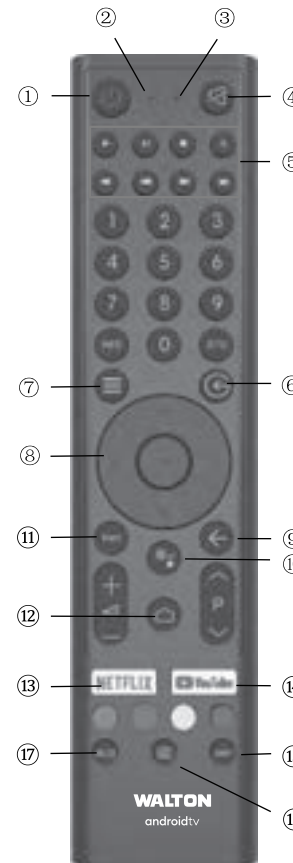

1. Switches the TV between on and standby mode
2. Indicator light
3. Microphone hole
4. Mute or restore TV sound
5. Media control
 - Fast forward/back
 - Play the last/next program
 - Play/Pause/Stop/Record program
6. Inputs
 - Display/Select signal source options
7. Menu
 - Displays the OSD (On Screen Display) menu
8. Navigation buttons
 - Cursor UP/LEFT/RIGHT/DOWN
9. Back
 - Press to move back through menus
10. Google Assistant
11. Exit
 - Exit the OSD menu
12. HOME
 - Displays the home screen.
13. NETFLIX
 - Connects to NETFLIX for viewing online TV shows and films (internet connection required).
14. YouTube
 - Connects to YouTube (internet connection required).
15. SUBT
16. Teletext
 - Turn on and off the teletext function. (DTV mode)
17. Audio
 - Displays the Audio Language list and select an audio language or audio format if available (only applicable when the TV programme has this feature)

BASIC OPERATION

SOURCE

- 1). In the HOME interface, press ▲▼ to select the "Inputs" icon, press OK to open the input source list, then press up to highlight an input and press OK to switch.
- 2). Under live TV, press the SOURCE button to display the list of input sources. You can select the desired source

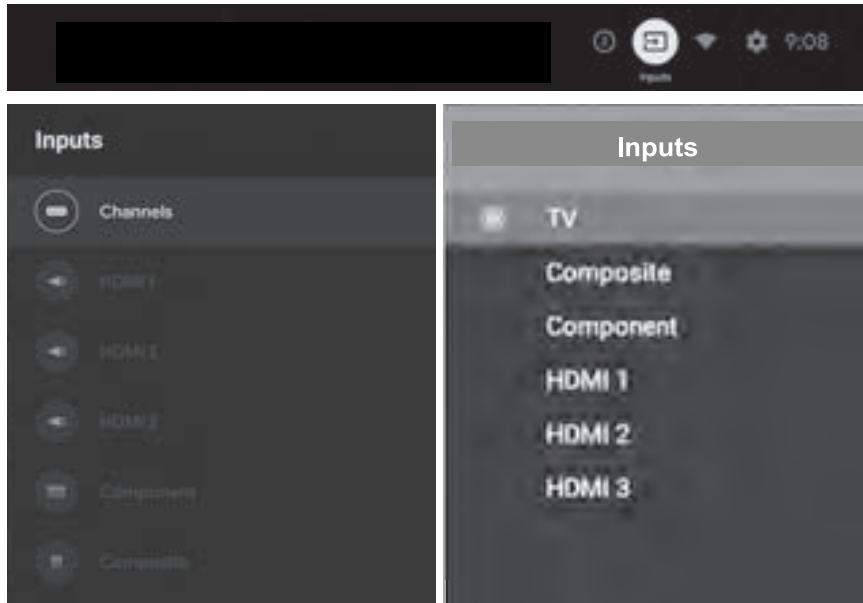

Initial Setup

1. Select your preferred language of usage from the menu given.

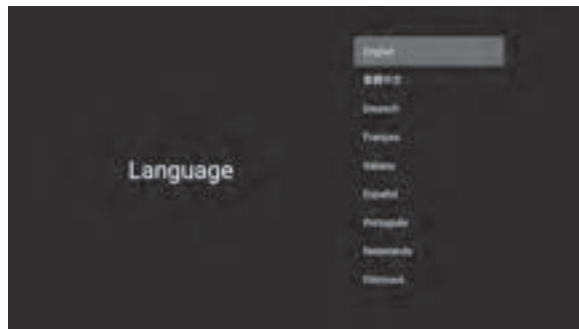

Note : English is the preferred language, but you can choose any other as well.

BASIC OPERATION

2. After language selection, Walton TV will prompt the user to pair the Bluetooth enabled remote control by pressing the Back and Vol - navigation button on the remote simultaneously, until it is detected. Then select the device that appears on the right side of screen and press 'OK'.

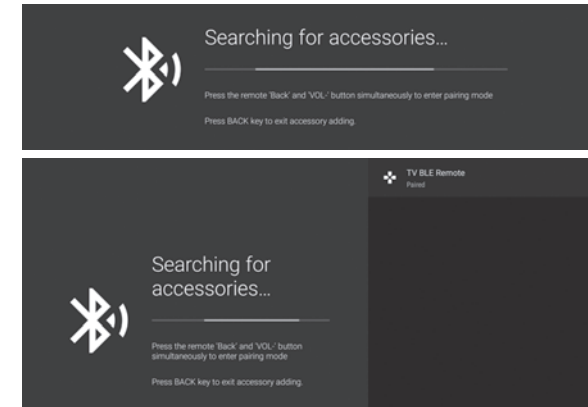

3. Next, if you want to setup your television and GOOGLE from you android phone press 'Continue' otherwise press 'Skip'
Note : If you press 'Continue' follow the section "Easy setup with phone" on page



4. After pressing 'Skip', in the next page, setup your Wifi network or connect to internet using the Ethernet cable. For connecting to Wifi, use the {up down} keys to select your home wifi network and press OK.



BASIC OPERATION

5. On the next page input your Wifi password and press OK.

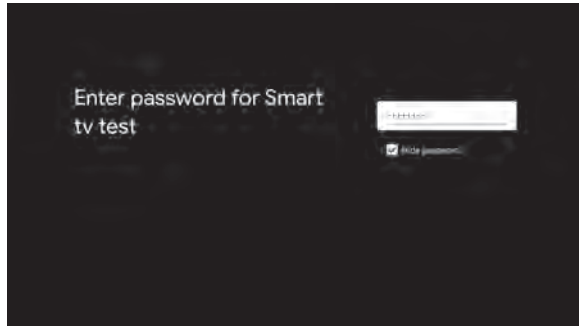

6. After connecting successfully, press 'Sign in' for logging into your google account or press 'Skip' if you do not want to.

Note : If you press 'Sign in' follow the section 'Sign in to google account' on page {...}



7. Use the { up, down} keys to navigate the options and select "Accept" to continue setup.



BASIC OPERATION

8. Next, either select 'Yes' or 'No' using the {up down} keys and press OK



9. Here also, either select 'Yes' or 'No' using the {up down} keys and press OK



10. Use the {up down} keys to select the applications you want to install and then use the {side>} keys to select 'Continue' button and press OK.

Note : It is recommended to install all the applications listed from Google.



BASIC OPERATION

11. Use the {>} keys four times to skim through the key features as shown above



12. Use the {up down} keys to select 'Bangladesh' and then press OK

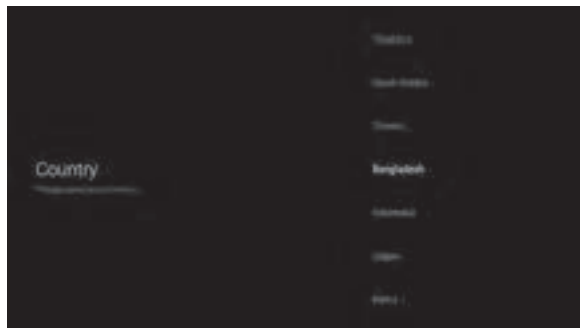

13. Next press OK to select 'Input password and enter a four digit password of your choice and then press OK. For confirming repeat entering the password again followed by the OK button.

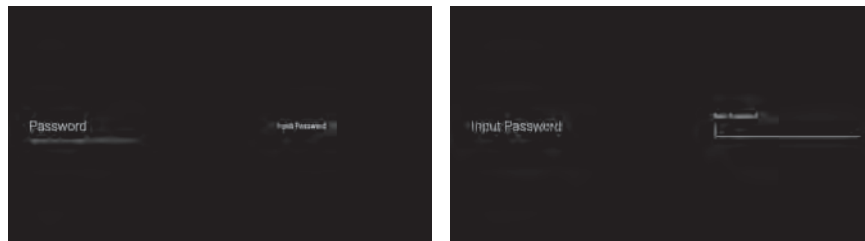

BASIC OPERATION

14. For selecting TV mode select 'Home' , press OK and on the next page select 'Yes' and press OK.

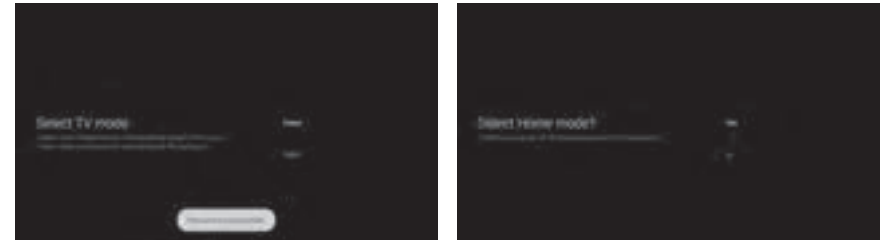

15. Turn on Chromecast by using the {up down} button to select 'On' and press OK

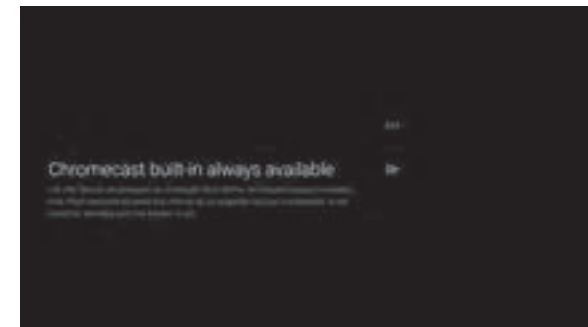

16. In this page press OK on the 'Accept' button to complete setup and enter homepage.



BASIC OPERATION

Easy setup with phone

(Continued from step 3. of Initial Setup section)

1. If you have pressed 'Continue' in step 3. , the following Quick setup page appears. Following the instructions on the page, open the google app on your phone and type or say "OK google set up my device".



2. As syncing starts. press NEXT on your phone to turn on Bluetooth and NEXT again if the code on your phone matches the one displayed on TV screen

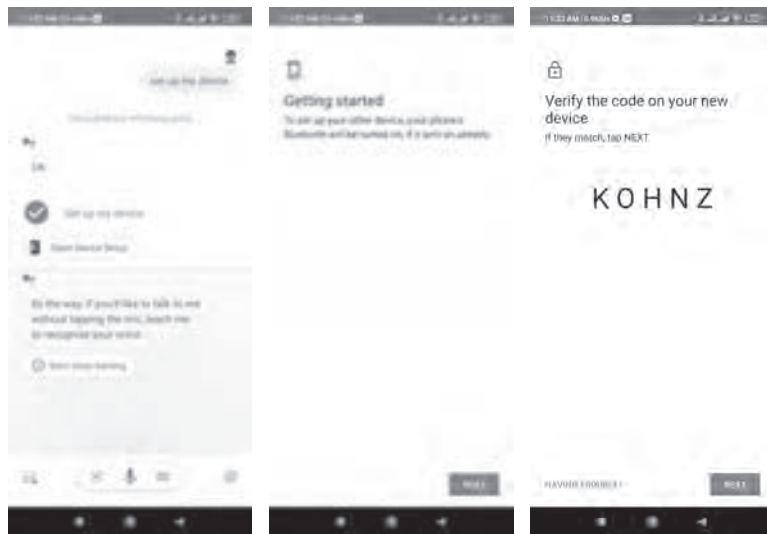

BASIC OPERATION

3. Now connect to the same wifi network that you want your TV to connect.

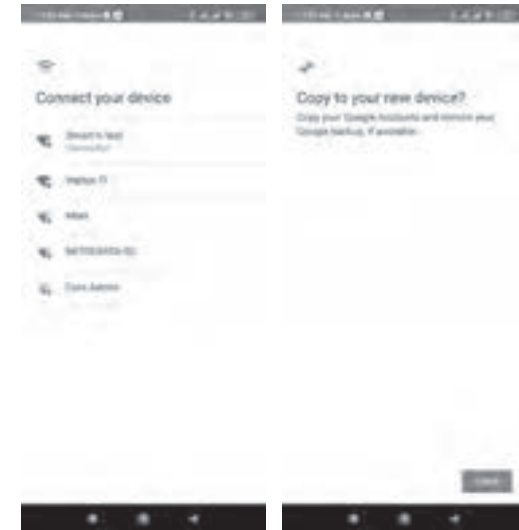

4. Press COPY and then choose the google account you want to use on TV. Press close when it's done.

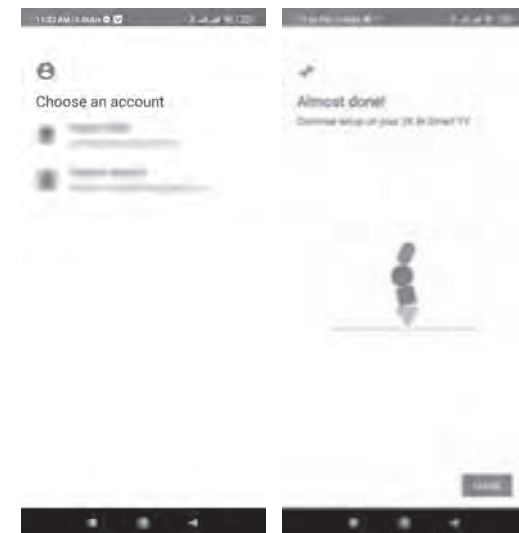

BASIC OPERATION

5. Use the { up, down} keys to navigate the options and select "Accept" to continue setup.



6. Next press continue on the next four screens and then choose 'Turn on' or 'No thanks' on the 'Get personal results' screen depending on your choice. Turn on will enable you to access the personal information in your google account on your TV using voice search

Continue from step 4. Of 'Initial Setup' section









BASIC OPERATION

HOME Screen

During initial setup, press EXIT to exit the initial setup, and enter the HOME screen.



-  Open the Google assistant or start a voice search
-  Among the applications installed on the TV, the icons for the favorite applications are shown inside here. (Favorite applications can be added / deleted / changed its order by users.)
-  Apps: Click to jump to Apps screen where all the installed applications are listed
-  Notifications: Display the notifications
-  Inputs: Icon to select an input source
-  Network & Internet: Icon to setup network, such as Wi-Fi
-  Settings: Various settings can be configured here

BASIC OPERATION

Settings

1. There are two ways to enter. First, in live TV, press the menu button to display TV options, press the Menu button to display TV options, press ◀▶/ ▲▼ to select the Settings menu and press OK to confirm. Second, in the Home interface, press the ▶ to select the icon of the circular settings menu, press OK to confirm.



2. Press ▲▼ button to select what you want set
3. Press OK to enter setting

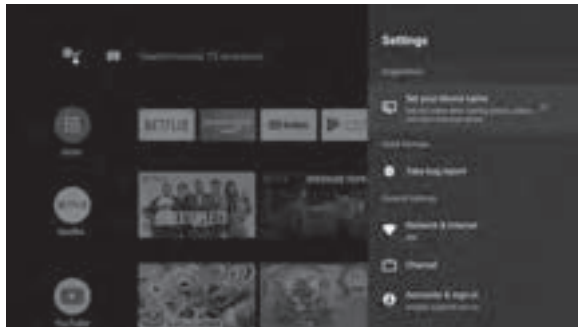

Press BACK to return to the previous menu. If the main menu is displayed, pressing BACK will close the onscreen menu.

BASIC OPERATION

Picture



Picture Mode – Press ▲▼ button to select the option button to enter the sub menu. (Optional: User, Standard, Vivid, Sport, Movie, Game, Energy Saving).

Backlight/Brightness/Contrast/Saturation/HUE/Sharpness: Press ▲▼ button to select the option. Press ◀ to decrease the parameter, Press ▶ button to increase the parameter.

Gamma – Press ▲▼ button to select the option then press OK button to enter the sub-menu. (Optional: Dark, Middle, Bright)

Color Temperature – Press ▲▼ button to select the option then press OK button to enter the sub-menu.

Picture Format - Press ▲▼ button to select the option then press OK button to enter the sub-menu.

(Optional: Automatic/Super zoom/4:3/Movie expand 14:9/Movie expand 16:9/Wide screen/Full/ Unscaled).

HDR - Press ▲▼ button to select the option then press OK button to enter the sub-menu. (Optional: On/Off).

Advanced Video – Press ▲▼ button to select the option then press OK button to enter the sub-menu.

Color Tuner - Press ▲▼ button to select the option then press OK button to enter the sub-menu.

11 Point White Balance Correction – Press ▲▼ button to select the option then press OK button to enter the sub-menu.

Reset to Default – Reset all settings to the factory default.

BASIC OPERATION

Sound

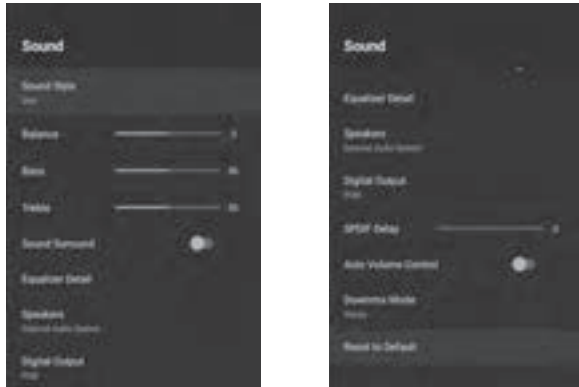

Sound style – Press ▲▼ button to select the option then press OK button to enter the sub-menu. (Optional: User/Standard/Vivid/Sports/Movie/Music/News).

Balance/ Bass/ Treble – Press ▲▼ button to select the option. Press ◀ to decrease the parameter, Press ▶ button to increase the parameter.

Sound Surround – Press ▲▼ button to select the option then press OK button to choose ON/OFF.

Equalizer Detail – Press ▲▼ button to select the option then press OK button to enter the sub-menu.

Speakers – Press ▲▼ button to select the option then press OK button to enter the sub-menu. (Optional: TV Speaker, External Audio System)

Digital Output – Press ▲▼ button to select the option then press OK button to enter the sub-menu. (Optional: Auto, Bypass, PCM, Dolby Digital Plus, Dolby Digital).

SPDIF Delay – Press ▲▼ button to select the option. Press ◀ to decrease the parameter, Press ▶ button to increase the parameter.

Auto Volume Control – Press ▲▼ button to select the option then press OK button to choose ON/OFF.

Downmix Mode – Press ▲▼ button to select the option then press OK button to enter the sub-menu. (Optional: Stereo/Surround).

Reset to Default – Reset all settings to the factory default.

BASIC OPERATION

Channel

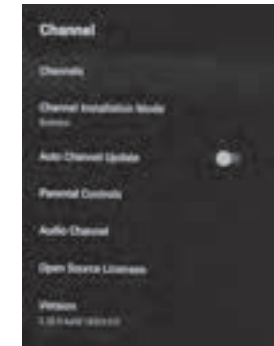

Channels – Display the scan sub-menu based on different channel installation modes.

Channel installation mode – Select on-screen display channel sources. You can select the signal type

Antenna – Set the signal type to antenna. When set to Antenna, the TV can receive analog and digital (DVBT/T2) broadcasting signals.

Cable – Set the signal type to cable. When set to Cable, the TV can receive analog and QAM broadcasting signals.

Preferred Satellite/General Satellite – Set the signal type to Satellite. When set to Cable, the TV can receive analog and Satellite broadcasting signals.

Auto Channel Update

Parental controls – Press ▲▼ button to select the option then press OK button to enter the sub-menu.

Audio Channel – Press ▲▼ button to select the option then press OK button to enter the sub-menu.

Open source licenses – Press ENTER to read the licenses

Antenna

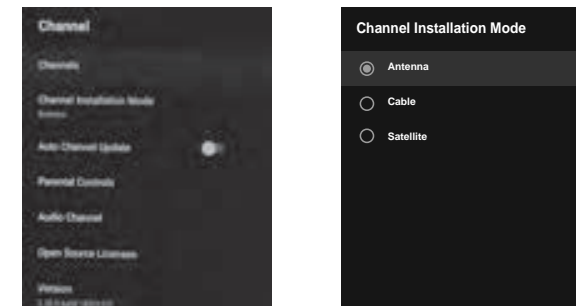

1. Menu->Settings->Channel->Channel Installation Mode > enter, choose Antenna

BASIC OPERATION

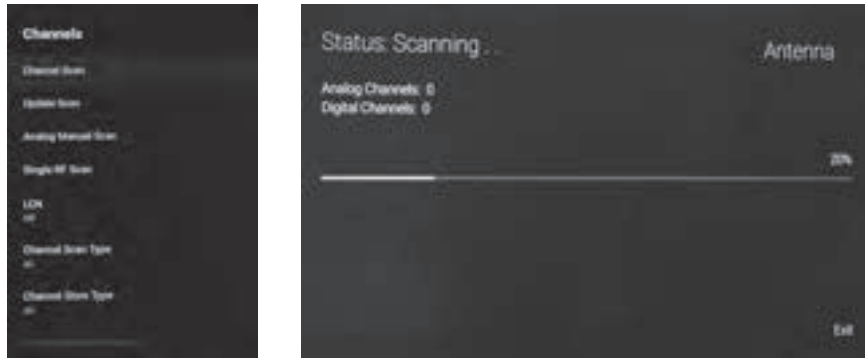

2. Enter Menu->Settings->Channel->Channels
3. Channel Scan directly enters the ATV+DTV automatic search platform interface of Antenna.
Update Scan: Re-automatically search for frequency points outside the station.



Analog Manual Scan: Manual ATV search station. After input the frequency point, you can select up or down search station.

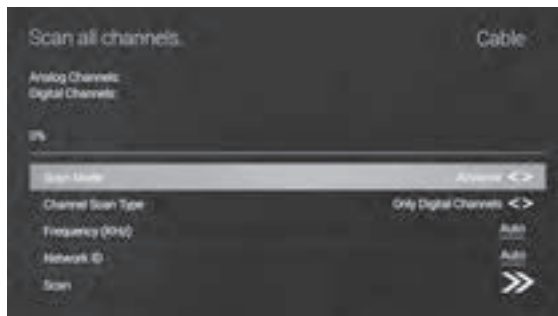

Single RF Scan: DTV manual search, left and right after selecting RF Channel, directly OK search

BASIC OPERATION

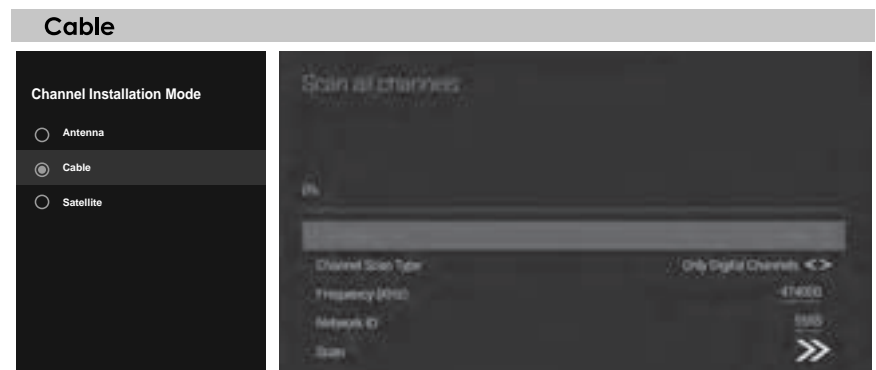

1. Menu->Settings->Channel->Channel Installation Mode-> select Cable
2. Enter Menu->Settings->Channel->Channels
3. Enter Channel Scan, where Akado, Divan TV, Online and Rostelecom (SPB) are the local operators, and the default Scan Mode is Advance; Others have Advance, Quick and Full Scan modes.

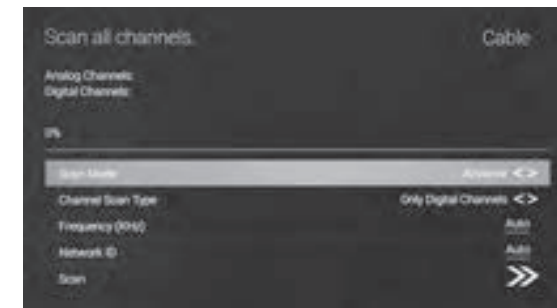

4. **Single RF Scan:** manual search station

Satellite

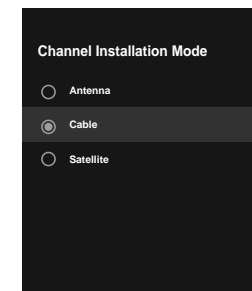

1. Menu->Settings->Channel->Channel Installation Mode->Select Satellite

BASIC OPERATION

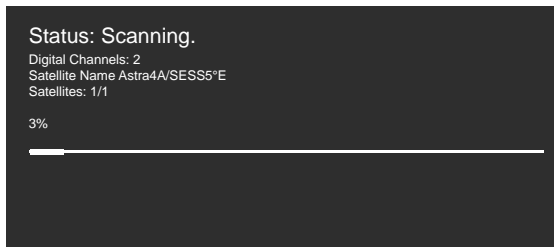

2. Enter Menu->Settings->Channel->Channels->Satellite Re-Scan->Enter OK
3. Satellite Manual Tuning: Enter Menu->Settings->Channel->Channels->Satellite Manual Tuning->Enter OK

CI Card Setup

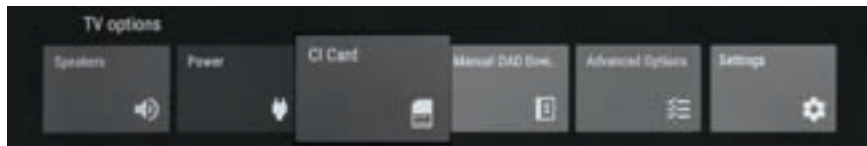

1. Insert CI card to CI slot to watch Pay TV channels
2. Press menu & Select CI tab to watch Pay TV channels with CI card

Date and Time

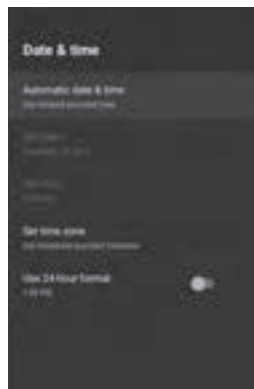

BASIC OPERATION

Automatic date & time – Press ▲▼ button to select the option then press OK button to enter the sub-menu.(Optional: Use network - provided time, Off).

Note: Manually adjusting date & time settings will automatically change the Automatic date & time to OFF

Set date – Press ▲▼ button to select the option then press OK button to enter the sub-menu.

Set time – Press ▲▼ button to select the option then press OK button to enter the sub-menu.

Set time zone – Press ▲▼ button to select the option then press OK button to enter the sub-menu.

Use 24-hour format – Press ▲▼ button to select the option then press OK button to choose ON/OFF

TIMER



Power On Timer Type – Press ▲▼ button to select the option then press OK button to choose ON/OFF/ONCE

Power On Timer – Press ▲▼ button to select the option then press OK button to enter the sub-menu.

Power Off Timer Type - Press ▲▼ button to select the option then press OK button to choose ON/OFF/ONCE

Power Off Timer – Press ▲▼ button to select the option then press OK button to enter the sub-menu.

BASIC OPERATION

Network

1. Press ▲▼ button to select what you want to set
2. Press OK button to adjust
3. After finishing adjustment, press OK button to save and return to previous menu.



Other Information

LANGUAGE

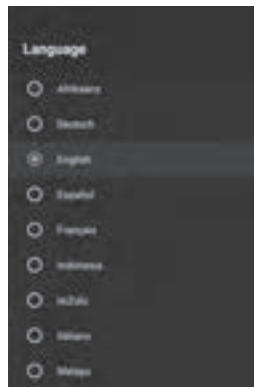

Language – Press ▲▼ button to select the option then press OK button to enter the select language

BASIC OPERATION

KEYBOARD



Current Keyboard – Press ▲▼ button to select the option then press OK button to enter the sub-menu.

Gboard Settings – Press ▲▼ button to select the option then press OK button to enter the sub-menu.

Manage keyboards – Press ▲▼ button to select the option then press OK button to enter the sub-menu.

INPUTS



Inputs – Press ▲▼ button to select the option then press OK button to enter the sub-menu.

HDMI Control – Press ▲▼ button to select the option then press OK button to choose ON/OFF.

BASIC OPERATION

Device Auto Power OFF- Press ▲▼ button to select the option then press OK button to choose ON/OFF.

TV Auto Power ON- Press ▲▼ button to select the option then press OK button to choose ON/OFF.

HDMI EDID Version – show EDID version.

CEC Device List – Press ▲▼ button to select the option then press OK button to enter the sub-menu.

POWER

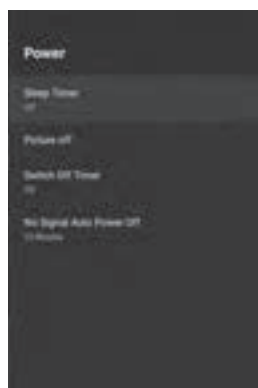

Sleep Timer - Press ▲▼ button to select the option then press OK button to enter the sub-menu. (Optional: Off, 10 mins, 20 mins, 30 mins, 40 mins, 60 mins, 90 mins, 120 mins).

Picture Off – Press ▲▼ button to select the option then press OK button to choose ON/OFF.

Switch Off Timer - Press ▲▼ button to select the option then press OK button to enter the sub-menu. (Optional: Off, 30 mins, 60 mins, 90 mins, 120 mins, 150 mins, 180 mins, 210 mins, 240 mins).

No Signal Auto Power Off - Press ▲▼ button to select the option then press OK button to enter the sub-menu. (Optional: Off, 5 mins, 10 mins, 15 mins, 30 mins, 60 mins).

BASIC OPERATION

STORAGE

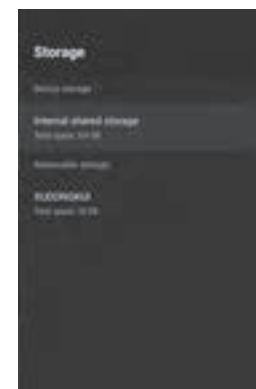

Internal shared storage – Press ▲▼ button to select the option then press OK button to enter the sub-menu.

Removable Storage – Press ▲▼ button to select the option then press OK button to enter the sub-menu. (Note: Show external devices if available)

HOME SCREEN

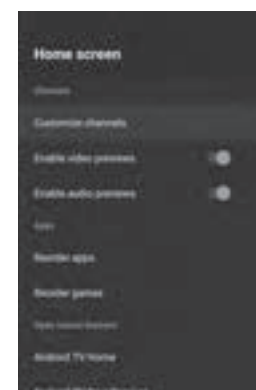

In this menu, you can set channels, apps, open source licenses.

1. Press ▲▼ button to select what you want to set
2. Press OK button to adjust
3. After finishing adjustment, press BACK button to previous menu.

BASIC OPERATION

STORE MODE



Store Mode – Press ▲▼ button to select the option then press OK button to choose ON/OFF.

GOOGLE

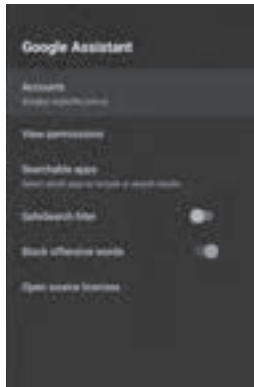

In this Menu, you set searchable apps, safe search filter, block offensive words, open source licenses.

1. Press ▲▼ button to select what you want to set
2. Press OK button to adjust
3. After finishing adjustment, press BACK button to previous menu

BASIC OPERATION

CHROMECAST BUILT-IN

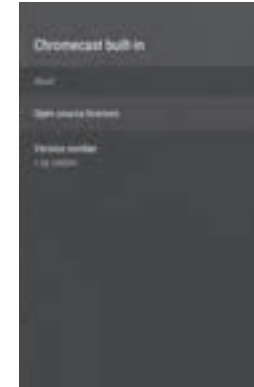

In this Menu, you can read the information of chromecast.

1. Press ▲▼ button to select what you want to read
2. Press OK button to open
3. After finishing reading, press BACK button to previous menu

SCREEN SAVER

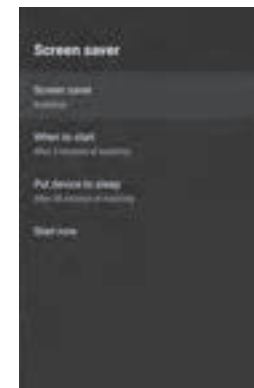

Screen saver – Press ▲▼ button to select the option then press OK button to enter the sub-menu. (Optional: Turn Screen Off, Backdrop, Colors)

When To Start – Press ▲▼ button to select the option then press OK button to enter the sub-menu. (Optional: 5 mins, 15 mins, 30 mins, 1 hour)

Put device to sleep – Press ▲▼ button to select the option then press OK button to enter the sub-menu. (Optional: 30 mins, 1 hour, 3 hours, 6 hours, 12 hours, Never)

Start now – Press ▲▼ button to select the option then press OK button to enter the screen saver.

BASIC OPERATION

LOCATION



Location Status – Press ▲▼ button to select the option then press OK button to enter the sub-menu. (Optional: Use Wi-Fi to estimate location, Off)

USAGE & DIAGNOSTICS



Usage & Diagnostics – Press ◀▶ / ▶▶ button to select the option then press OK button to choose ON/OFF.

BASIC OPERATION

ACCESSIBILITY

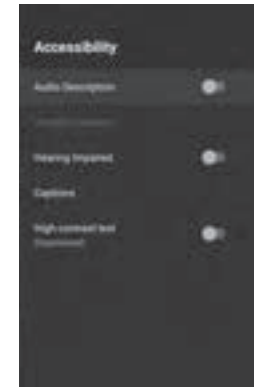

Captions – Press ▲▼ button to select the option then press OK button to enter the sub-menu.

High Contrast Text – Press ▲▼ button to select the option then press OK button to choose ON/OFF.

ABOUT



In this Menu, you can read the information and settings of TV.

1. Press ▲▼ button to select what you want to set
2. Press OK button to adjust
3. After finishing adjustment, press BACK button to previous menu

RESET

Press OK button to enter the sub-menu. Reset- Erase everything.

BASIC OPERATION

REMOTE & ACCESSORIES

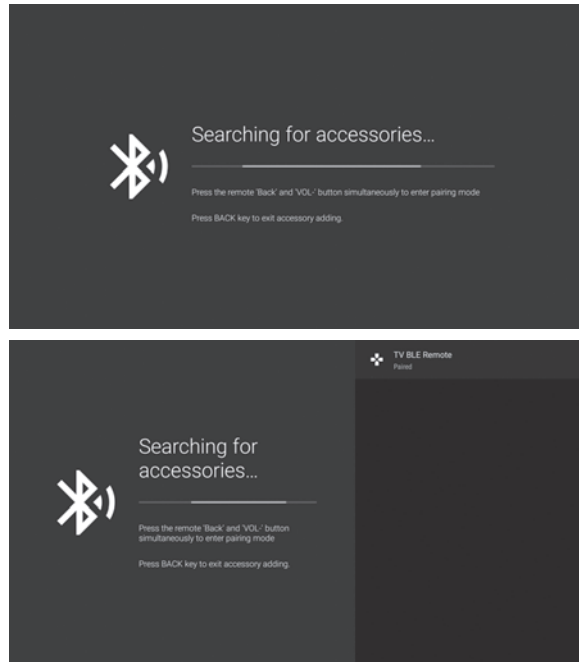

In this menu, you can pair Bluetooth devices.

1. Press the "Back" and "Vol -" buttons at the bottom of the remote control for 5 seconds.
2. When the LED starts to flash, release it. The remote controller will send the pairing signal to the TV and display the information of remote control on the right side of the screen.
3. Press the OK button to display the pairing. If the paired is displayed, the connection is successful.
4. If the couldn't pair appears, the connection fails. Wait 30 seconds and then press the "HOME" and "LEFT" buttons at the bottom of the remote control for 5 seconds to repeat the previous steps.
5. Press BACK or EXIT button return to the previous menu.

MULTIMEDIA OPERATION

Add and use of Multimedia Player



1. In the HOME interface, select the + icon in the APP column to add the application, and click OK. Press up and down to select the Multi Media Player application, and click OK to add it to the HOME interface.

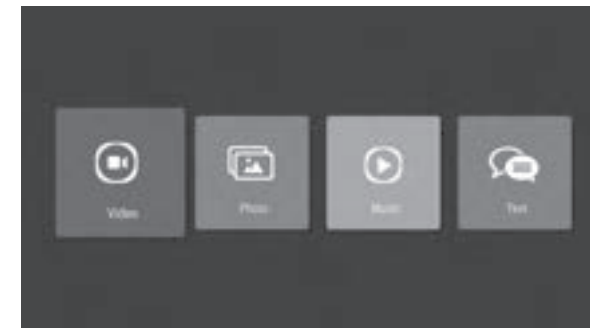

2. Select OK key to enter Multi Media player and display Video, Photo, and Audio Text. After inserting the USB flash drive, you can view corresponding files in the USB flash drive.

Note: The Menu may be different depending on when you purchased the TV.

MULTIMEDIA OPERATION

Video



Press [◀] / [▶] button to select Video.

MULTIMEDIA OPERATION

Photo



Press [◀] / [▶] button to select Photo.

MULTIMEDIA OPERATION

Music

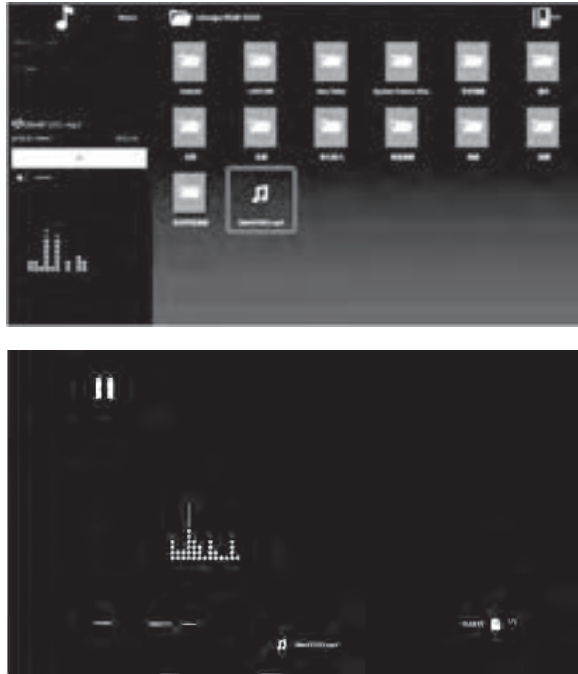

Press **【◀】 / 【▶】** button to select Music.

Text



Press **【◀】 / 【▶】** button to select Text.

MULTIMEDIA OPERATION

Gentle Reminder When Using USB Player

- ❖ Some USB storage devices may not be compatible to operate smoothly on this LED TV
- ❖ Back up all of the data in the USB storage device in case of data lost due to any accident. We do not assume any liabilities for the loss of data due to misuse or malfunction. Data back-up is customer's responsibility.
- ❖ For larger file sizes, loading speed may be slower.
- ❖ The recognition speed of USB storage device may depend on each device.
- ❖ When connecting or disconnecting the USB storage device, please make sure that the TV is not in UB mode, otherwise the USB storage device or the files in it may be damaged.
- ❖ Please use only a USB storage device formatted in FAT32, NTFS file system provided with the windows operating system. In case of a USB device formatted in different utility program which is not supported by windows, it may not be recognized.
- ❖ When using a USB Hard Disk Drive which requires electric power source, ensure its power does not exceed 500mA. If the power of USB Hard Disk Drive exceeds 500 mA, the TV system will be changed to Standby mode; you must pull away the USB Hard Disk and restart the TV system.
- ❖ An "Unsupported File" message will be displayed if the file format is not supported.
- ❖ High Resolution picture needs longer time to load; it's not caused by TV. Please be patient while loading.
- ❖ This TV may not support some Multimedia files changed and upgraded as the change of encoding or other technical advances.

BUILT-IN APPS

- ❖ Netflix: Enjoy latest TV series and movies on Netflix.
- ❖ You Tube: Enjoy video contents and live channels on You Tube.
- ❖ Google Play Store: Download apps of your desire from Netrange App Store.
- ❖ Kids: Kids can enjoy kids content via You Tube Kids.
- ❖ Chromecast: Cast your phone on TV screen via W-Fi hotspot for better viewing experience.
- ❖ Browser: Enjoy smooth internet browsing via Browser app.

TROUBLESHOOTING

No Picture, No Sound

1. Check if the fuse or CB is working.
2. Plug another electrical device to the outlet to make sure it is working.
3. Power Plug is in bad contact with the outlet.
4. Check the signal source.

No Color

1. Change the color system.
2. Adjust the saturation.
3. Try another channel-Black & White program may be received.

Remote Control Does Not Work

1. Change the Batteries.
2. Batteries are not properly installed.
3. Main Power is not connected.

No picture, Normal Sound

1. Adjust brightness and contrast.
2. Broadcasting failure may happen.

Normal Picture, No Sound

1. Check if volume is Mute.
2. Press Volume Up button to increase sound.
3. Change sound system.
4. Broadcasting failure may happen.

Irregular Ripples on Picture

1. Usually caused due to local interference like cars, daylight lamps and hair driers; try adjusting antenna to minimize interference.

Snowy Dots and Interference

If the antenna is located in the fridge area of Television signal where the signal is weak, the picture may be marred by dots. When the signal is extremely weak, it may be necessary to install a special antenna to improve the reception.

1. Adjust the position and orientation of indoor/outdoor antenna.
2. Check the connection of antenna.
3. Fine tune the channel.
4. Try another channel. Broadcasting failure may happen.

TROUBLESHOOTING

Ignition

Black spots or horizontal streaks appear or the picture drifts; this is due to interference from car ignition system, neon lamps etc.

Ghost

Ghosts are caused by television signal following two paths. One is direct path and the other is reflected from tall buildings, hills or other objects. Changing the direction or position of the antenna may improve reception.

Radio Frequency Interference

This interference produces moving ripples or diagonal streaks; in some cases loss of contrast. Radio frequency source has to be sorted and removed.

Reset

Due to installation of a lot of applications, operating system might get slower and can cause TV hang issue. In that case, please use RESET option to remove all junk files and reset your TV at preliminary conditions for better performance.

Note:

If all the problems persist after attempting solution, please contact your local support center.

SPECIFICATIONS

Information	W32D120GE	WD40RGE	W43D210GE
Size	813 mm	1.016 m	1.09 m
Working Voltage	100V-240V	100V-240V	100V-240V
Power Consumption	45W	65W	75W
Audio Output	8W + 8W	8W + 8W	8W + 8W
Dimension (LxWxH) (TV without stand)	733 x 78 x 433 mm	905 x 70 x 520 mm	963 x 77 x 569 mm
Net weight	3.84 KG	6.24 KG	7.6 KG

Environment (only for Tropical Climate zones):

Working Temperature: 5°C~45°C
 Working Humidity: 20%~80%
 Storage Temperature: -15°C~50°C
 Storage Humidity: 10%~90%

Environment (only for Moderate Climate zones):

Working Temperature: 5°C~35°C
 Working Humidity: 20%~80%
 Storage Temperature: -15°C~45°C
 Storage Humidity: 10%~90%

Program Coverage:

ATV: 47.25 MHz-867.25MHz Full Program Cable TV
 DTV: VHF(50 MHz-230 MHz); UHF(474 MHz-862 MHz)

System:

ATV :PAL/SECAM/BG/DK/I/L/L'
 AV:PAL/SECAM/NTSC Playback
 DTV: DVB-T/T2/S/S2/C

Status Displaying Method: On Screen Display

Function Adjustment Indicator: Menu Display

Language of OSD: Multiple options

RF Aerial Input: 75 Ohm unbalanced

AV Video Input: 75Ohm; 1.0V_{P-P} RCA

AV Audio Input: 10KOhm, 0.5Vrms

Please notice - All products are subject to change without any notice. We take reservations for errors and omissions in the manual.

 | Product complies with the European Safety Regulations

 | Class II equipment

 | This marking indicates that this product should not be disposed with other household wastes throughout the EU. To prevent possible harm to the environment or human health from uncontrolled waste disposal, recycle it responsibly to promote the sustainable reuse of material resources. To return your used device, please use the return and collection systems or contact the retailer where the product was purchased. They can take this product for environment safe recycling.

For pluggable equipment, the socket-outlet shall be easily accessible stability Hazard
The television set may fall, causing serious personal injury or death.

Never place a television set in an unstable location. A television set may fall, causing serious personal injury or death. Many injuries, particularly to children, can be avoided by taking simple precautions such as:

- Using cabinets or stands recommended by the manufacturer of the television set.
- Only using furniture that can safely support the television set.
- Ensuring the television set is not overhanging the edge of the supporting furniture.
- Not placing the television set on tall furniture (for example, cupboards or bookcases)
Without anchoring both the furniture and the television set to a suitable support.
- Not placing the television set on cloth or other materials that may be located between the television set and supporting furniture.
- Education children about the dangers of climbing on furniture to reach the television set or its controls.