



## 6.1 Hobs with knobs

### 6.1.1 Single cooking zones

Each knob shows the cooking zone it is for.

For example, there is one symbol identifies the knob that controls the rear right-hand cooking zone.

To heat, turn the knob to the desired position (low to high). Adjustment is continuous so that the appliance also operates at any intermediate value.

### 6.1.2 Dual cooking zones

Each knob shows the cooking zone it is for.

For example, there is one symbol identifies the knob that controls the rear right-hand cooking zone.

To heat the inner cooking zone, turn the knob to the desired position (low to high).

To heat both the inner and outer cooking zones, turn the knob to  and then release. The knob will thus return to maximum. To adjust heating intensity, rotate the knob anticlockwise to the desired position.

To return to heating of the inner cooking zone only, set the knob back to 0 and then turn to the desired position

(low to high).

### 6.1.3 Description of symbols



### 6.1.4 Residual heat

The warning lights located between the cooking zones come on when the temperature of one or more of the zones exceeds 60°C.

The lights go off upon temperature dropping to below approximately 60°C.

### 6.1.5 Switching off

To turn off, return the knob to 0.



## 6.2 Hobs with touch-control buttons



When an icon is pressed the unit beeps to confirm.

To operate the panel of the hobs equipped with touch-controls, lightly press the icons printed on its surface.



On first connection to the electrical mains, an operating check will be carried out automatically and all the indicator lights will come on for a few seconds.

### 6.2.1 Switching on the hob

When not in use, all hob components will be switched off. Hold down switch key for 2 seconds to switch the hob on; a led will turn on above the symbol to confirm that the hob is lit. If no functions are used within

10 seconds of switching the hob on, it will automatically turn itself off.

### 6.2.2 Single cooking zones

The associated cooking zone is indicated close to each control zone. For example, there is a symbol identifies the knob that controls the rear right-hand cooking zone.

After turning on the hob as described in paragraph "7.2.1 Turning on the Hob", press the keys "+" and "-" to activate the cooking zone (display indicating 0) and adjust the power at which it should operate. The power settings range from a minimum of 1 to a maximum of 9.

You must adjust the power within 10 seconds from when the cooking zone is activated, otherwise it will automatically deactivate.

Press the "+" and "-" buttons in the following way to activate the cooking zone and adjust its power:

1. press the symbol "+" (0 appears on the display: this means that the cooking zone is activated);
2. by continuing to press the symbol "+", you can adjust the power of the cooking zone up to the maximum value of 9;
3. if you instead press the symbol "-", you adjust the power of the cooking zone down to the minimum value of 1.



### 6.2.3 Dual cooking zones

To activate heating of the dual cooking zone, once power 9 is reached by following the instructions provided in paragraph "7.2.2 Single cooking zones", press the "+" again. Now the maximum power of the cooking zone is activated, and is shown by the LED light turning on next to the number indicating the operating power. Press on the symbols "+" and "-" to adjust the power of the dual cooking zone to the desired value.

### 6.2.6 Cooking zone lock-out

The cooking zone lock-out function is a user safety functions. It locks out the hob controls to prevent the ceramic cooking zones being switched on accidentally.

Hold down lock key for 1 second to lock out the hob. The hob can be reactivated by holding down lock key again for 1 second.



### 6.2.7 Cooking zone layout

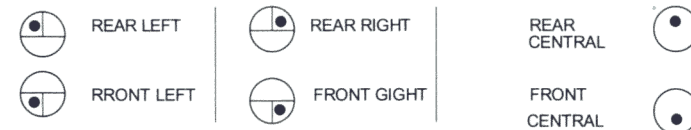



### 6.2.8 Timer (on some models only)

Some models are equipped with a 1 to 99-minute cooking timer.

To use the timed cooking, first set the power level by following the instructions given in paragraphs "6.2.2 Single Cooking Zones" and "7.2.3 Dual Cooking Zones".

Now, with the hob NOT locked out (if it is locked out, press the "☺" key to enable the functions), press the time symbol.

Between the symbols "+" and "-" of the first active cooking zone, a LED light will turn on to indicate that the minutes to be set will refer to operation of that particular zone.

The automatic operation minutes of the cooking zone can be increased or decreased by using the "+" and "-" keys beside.

After 5 seconds have gone by since the last time it is pressed, the timer will start and the cooking zone will operate until the display above the time symbol reaches 0.

At this point the cooking zone will automatically turn off.

It is also possible to use the timed cooking function on more than cooking zone at the same time. Once the timer is set on the first zone, press time key to shift the timer controls over to the next active zone (the LED light between the symbols "+" and "-" of the second active cooking zone will be activated) and then set the cooking duration as previously described.

When the timed cooking is active on several cooking zones at the same time, the display between the symbols "+" and "-" of the cooking zone will alternatively turn on and at the same time the minutes display found on the time symbol will show the time remaining for the zone with the LED light on.

### 6.2.9 Modifying the data set

During timed cooking, each single pressure on the "+" and "-" symbols increases or reduces the power of the cooking zone.

To change the remaining time of a zone, you have to press time key until the LED light in the cooking zone turns on. Now it will be possible to change the operating time by working with the symbols "+" and "-" of the timer.

### 6.2.10 Residual heat

Each cooking zone is equipped with a residual heat warning device. After any zone is switched off, a flashing "H" may appear on the display. This warns that the cooking zone concerned is still very hot. Cooking can be restarted while the "H" is flashing; proceed as described in points "7.2.2 / 7.2.3".

### 6.2.11 Control circuit board thermal protection

If the cooking zones cause overheating of the internal electronic circuit board, the heat will be switched off automatically. This switches off power to the front zones, and the letters "H" and "E" flash alternately on the power leds. If the circuit board does not cool down, power to all the cooking zones is switched off, and the power leds display the text "H H H H". Cooking can be resumed once the temperature has dropped below the safety threshold.

### 6.2.12 Operator Error

If the user makes a mistake when using the push-buttons, an "E" appears on the power display; it will remain there as long as the user continues to press the button being used incorrectly.

### 6.2.13 Switching off the cooking zones

The cooking zones are switched off when the operational power display indicates 0. The zone will automatically deactivate 5 seconds after the display shows 0.

If the cooking zones are hot, the blinking residual heat "H" will appear after they are switched off.



## 6. USE OF THE COOKING HOB

### 1. Preparation

Please ensure the knob switch or sensor switch is off, then connected to the mains. Using the solid pan with flat bottom, it should satisfy to the request of the standard DIN44094.

These diameters for professional pan have been suitable to the electrical hob.

Pan diameter mm	140	160	200	240
Hob diameter mm	120	140	180	220

### 2. Single cooking zones

turn the knob clockwise. now the hob is working, radiate hob will get hot and red in 3 seconds, and the power lamp lights. When the knob is at the maximum out-put frequency position of 308 degree, the hob reach the maximum out-put frequency (long time loads, shot time interval); out-put frequency gets lower when turning anticlockwise (short time loads, long time interval).

You can switch off the hob in both directions. The residual heat warning lamp lights when the temperature of the ceramic glass surface higher than 70 degrees centigrade, it will put out while the temperature lower than 70 degree centigrade.

### 3. Dual cooking zones

turn the knob clockwise. now the hob is working, radiate hob will get hot and red in 3 seconds, and the power lamp lights. Now, the inner circle of the hob is working on, but not the outer circle. Continue to turn the knob when it is at the position of 308 degree clockwise to 328 degree position, then release the knob, it will return automatism to 308 degree position. Now both of the circles are working on, the hob reaches its maximum out-put frequency. If you want to return the single circle working status, you have to switch off the hob and reactive it.

You have to switch off only anticlockwise. The residual heat warning lamp lights when the temperature of the ceramic glass surface higher than 70 degrees centigrade, it will put out while the temperature lower than 70 degree centigrade.



### 5. DESCRIPTION OF CONTROL ON THE FRONT CONTROL PANEL

All the hob controls are grouped together on the front panel. The table below provides a description of the symbols used.



HOB IGNITION



REAR RIGHT-HAND COOKING ZONE



CONTROLS ON-OFF



FRONT RIGHT-HAND COOKING ZONE



VALUE INCREASE BUTTON



FRONT LEFT-HAND COOKING ZONE



VALUE DECREASE BUTTON



REAR LEFT-HAND COOKING ZONE



TIMER SETTING BUTTON



REAR CENTRAL COOKING ZONE



DUAL COOKING ZONE



FRONT CENTRAL COOKING ZONE



#### 6.2.14 Switching off

To switch the hob off, hold down switch key for 1 second; this deactivates all cooking zones even if they are in use or the lock-out function is active, and the hob will turn off completely.

If the cooking zones have just been used,  will start flashing a few seconds after the hob is turned off to warn that they are still hot.

#### 6.3 Cooking tips

For best results and energy saving, only use pans suitable for electric cooking:

- The bottom of the pan must be very thick and perfectly flat; before placing on the cooking hob, make sure that the pan, as well as the cooking hob itself, is perfectly clean and dry.
- To avoid scratching of the cooking hob, never use cast-iron pans or pans with a rough bottom.
- To avoid waste of energy, make sure that the diameter of the pan bottom is 20mm bigger than the circle marked on the hob.

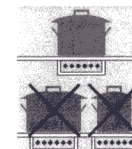



### 7. CLEANING AND MAINTENANCE

Before any intervention, disconnect the power supply of the device.



#### 7.1 Cleaning the ceramic hob



The hob should be regularly cleaned; preferably after every use, once the residual heat warning lights have gone off.

Smudges from aluminum-bottom pans can be easily cleaned off with a cloth dampened in vinegar.

Never use abrasive or corrosive detergents (e.g. cleaning powders, oven sprays, spot-removers, wire sponges).



NEVER USE A STEAM JET TO CLEAN THE APPLIANCE.

### 8. SOMETHING WRONG?

PROBLEM	POSSIBLE CAUSES	WHAT TO DO?
The hob doesn't work	<ul style="list-style-type: none"> <li>- The hob is not wired in or - switche on at the wall.</li> <li>- There is a power failure</li> </ul>	<ul style="list-style-type: none"> <li>- Switch on at the wall</li> <li>- Check power supply</li> </ul>
The results of cooking are unsatisfactory	<ul style="list-style-type: none"> <li>- Temperature is too high or too low</li> <li>- Wrong shelf position</li> <li>- Wrong type of dish</li> <li>- Cooking time is incorrect</li> </ul>	<ul style="list-style-type: none"> <li>- Consult cooking tips</li> </ul>
The hob smokes	<ul style="list-style-type: none"> <li>- The hob is dirty</li> <li>- Food has spilled over</li> </ul>	<ul style="list-style-type: none"> <li>- Clean the hob once cooking is finished. Let it cool first.</li> <li>- Use a larger pan</li> </ul>
The cooking zones do not come on during timed cooking	<ul style="list-style-type: none"> <li>- Timed cooking programming - error</li> </ul>	<ul style="list-style-type: none"> <li>- Check the instructions for timer</li> </ul>



### 4. COOKING ZONES

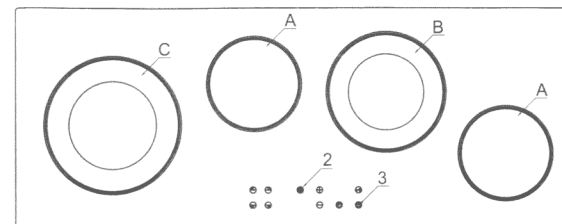

- A. Single cooking zone 1200W
- B. Dual cooking zone 1700/700W
- C. Dual cooking zone 2200/1000W

- 1 Power & Residual heat warning lights
- 2 Dual end sensor touch
- 3 Four ends sensor touch



### 3. BEFORE USE



Do not leave the packing in the home environment. Separate the various waste materials and take them to the nearest special garbage collection centre.



Before cooking for the first time the hob has to be cleaned. Following this, put a saucepan of water on the front hotplates and turn them full on for at least 30 minutes. After 30 minutes turn off the front hotplates and turn the rear hotplates and the central hotplate, if present, full on. This treatment is necessary in order to get rid of the "new smell" and to evaporate the humidity that may have collected during the manufacturing process. That is, it must be done so that the electronic circuits and the control buttons work properly. If the controls do not work properly after 30 minutes, it means that not all the humidity has evaporated: leave the hotplates on until all the humidity has evaporated and then turn off the hob.

Remove all the removable labels and any protective sheeting. To switch on the hob, follow the instructions provided in point "7".



### 9. INSTALLATION

#### Before installation

Installation and test must be carried out by professional technician. And the hob must be 150mm far away from the wall or anything else. To avoid interference of taking the households when cooking, in the place 300mm from the both sides of the hob must not be put any furniture or separate board. And the both sides of the hob should 300mm at least far away from the wall. The thickness of the table used to mounting the hob should be 30cm at least, and it should be heat resisting or be covered by a the heat resisting material.

#### 9.1 Technical information

Model	CC9GE1
Voltage(V)	220-240
Frequency(Hz)	50-60
Outer size(mm)	900x350x55
Cast dimension(mm)	880x330

#### 9.2 The rating plate

Make sure that the voltage and capacity of the power line conform to the data shown on the plate located under the casing. Do not remove this plate for any reason.

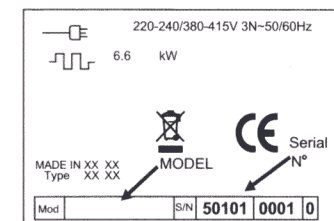

#### 9.3 Electrical connection

IT IS OBLIGATORY FOR THE ELECTRICAL SYSTEM TO BE GROUNDED ACCORDING TO THE METHODS REQUIRED BY SAFETY RULES.



BEFORE THE APPLIANCE BEING CONNECTED WITH THE MAINS, PLEASE DO ASSEMBLE ONE FULLPOLAR BREAKER WITH OVER 3MM OPENED ON THE MAINS, AND THE RATED CURRENT OF THE BREAKER IS STRONGLY RECOMMENED OVER 40A.



NEVER UNPLUG BY PULLING ON THE CABLE. IMMEDIATELY AFTER INSTALLATION CARRY OUT A BRIEF INSPECTION TEST OF THE HOB, FOLLOWING THE INSTRUCTIONS. IF THE HOB FAILS TO OPERATE, AFTER CHECKING THAT YOU HAVE CARRIED OUT THE INSTRUCTIONS CORRECTLY, DISCONNECT THE APPLIANCE FROM THE ELECTRICAL MAINS AND CONTACT YOUR NEAREST SERVICE CENTRE.



NEVER ATTEMPT TO REPAIR THE APPLIANCE. IF A PLUG AND SOCKET CONNECTION IS BEING USED MAKE SURE THAT THE PLUG AND SOCKET ARE COMPATIBLE. AVOID USE OF ADAPTERS AND SHUNTS AS THESE COULD CAUSE OVERHEATING AND RISK OF BURNS.



IF A FIXED CONNECTION IS BEING USED FIT POWER LINE WITH AN OMNIPOLAR CIRCUIT BREAKER WITH A CONTACT OPENING GAP EQUAL TO OR GREATER THAN 3 MM IN AN EASILY ACCESSIBLE POSITION IN PROXIMITY TO THE HOB.

## Instructions for the installer



If the appliance you have purchased is not fitted with a mains power lead a power lead resistant to a temperature of at least 90 °C must be used.

Otherwise, the electrical safety of the appliance may be put at risk.

The manufacturer declines all responsibility for damage to persons or things caused by non-observance of the above prescriptions or by interference with any part of the appliance.



Warning: close the cable clamp after making the electrical connection. Close the terminal board cover by twisting it down.

TERMINAL BOARD

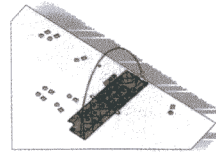

Components with product:

NO	Name	Qty	Unit
1	Electric hob	1	table
2	Installation and using manual	1	book
3			

### 9.4 POSITIONING OF THE HOB

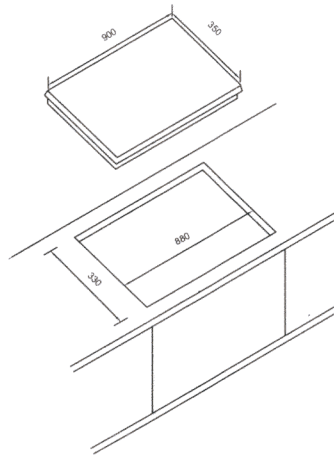

GB-IE

## Safety instruction

### 2. SAFETY INSTRUCTIONS



Instructions for the installer these are intended for the qualified technician who must install the appliance, set it functioning and carry out an inspection test.



It is obligatory for the electrical system to be grounded according to the methods required by safety rules.



The appliance without plug, When linking up to mains by plug and socket, make sure that both are compatible and connect by means of a power cable complying with applicable regulations.

The socket must be accessible after the appliance has been built in

Never unplug by pulling on the cable



Always check that the controls are in the position 0 (OFF) when you finish using the hob.



During use the appliance becomes very hot. Take care not to touch the surface of the hob



The appliance is intended for use by adults. Keep children at a safe distance and never allow them to play with it.



The appliance becomes very hot during use suitable heat proof gloves should be worn for all operations.



Before the appliance is put into operation. All the labels and protective films applied inside or outside must be removed.



Immediately after installation carry out a brief inspection test of the appliance, following the instructions below. Should the appliance not function, disconnect it from the power supply and call the nearest technical assistance center.



Never attempt to repair the appliance, all repairs must be carried out by an authorized engineer or at an authorized service centre.



Important.  
Beware of children in the vicinity as the warning lights indicating residual heat are out of sight to them. In fact, even after having been turned off, the cooking zone remains hot for a certain period of time.

Make sure that children never touch the hob.



## 1. INSTRUCTIONS FOR PROPER USE



Electrical connection please refer to installation instructions for the gas & electrical safety regulations and the ventilation requirements.

In your own interest, and that of safety, it is the law that all gas and electrical appliances be installed and serviced by competent persons, who will comply with the relevant standards and regulations. registered installers undertake to work to satisfactory standards.

Disconnection of gas and electric appliances should always be carried out by competent persons.



This manual is an integral part of the appliance and therefore must be kept in its entirety and in an accessible place for the whole working life of the hob. We advise reading this manual and all the instructions therein before using the hob. Installation must be carried out by qualified personnel in accordance with the regulations in force. This appliance is intended for domestic uses and conforms to current regulations in force. The appliance has been built to carry out the following functions. Cooking and heating-up of food. All other uses are considered improper.

The manufacturer declines all responsibility for improper use. Never use this appliance for heating rooms.



Do not leave the packing in the home environment. Separate the various waste materials and take them to the nearest special garbage collection centre.



This appliance is marked according to the European directive 2002/96/EC on waste electrical and electronic equipment (WEEE). This guideline is the frame of a European-wide validity of return and recycling on waste electrical and electronic equipment.



The identification plate, with technical data, serial number and marking is clearly visible under the casing.



**THE PLATE ON THE CASING MUST NOT BE REMOVED.**

Take care not to spill sugar or sweet mixtures on to the hob when hot. Never place materials or substances which may melt.



The manufacturer declines all responsibility for damage to persons or things caused by non-observance of the above prescriptions or by interference with any part of the appliance or by the use of non-original spares.



**WARNING:** If the surface is cracked, switch off the appliance to avoid the possibility of electric shock. During cleaning for the appliance, please do not use steam cleaner



The following operation requires building and/or carpentry work so must be carried out by a competent tradesman.

Installation can be carried out on various materials such as masonry, metal, solid wood or plastic laminated wood as long as they are heat resistant (T 90°C).

Create an opening with the dimensions shown in the paragraph 10.1 in the top surface of the counter, keeping a minimum distance of 50 mm from the rear edge.

This appliance can be mounted against walls higher than the work surface on condition that a certain distance be kept between the appliance and the wall as shown in the figure so as to avoid damage from overheating.

Make sure there is a minimum of 750 mm between the hob and any shelf that may be installed directly above them.

### 9.5 Mounting

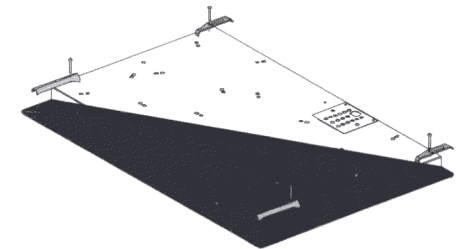
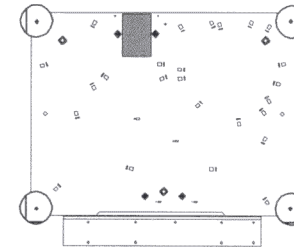

This appliance must not be built-in above a dishwasher. Installation of an oven without cooling fan underneath the hob is forbidden.



Pass the power supply cable through the back of the unit, taking care that it does not touch the bottom casing of the hob or the oven (if any) installed underneath it.



**IMPORTANT:** when installing the appliance above a cupboard, a dividing shelf, as shown above, must be installed.

If installed above an under-bench oven, this is not required.

Installation of an oven without cooking fan underneath the hob is forbidden.

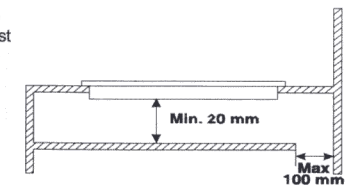

The diagrams illustrate the cutting sizes and additional shaping required for the installation if you decide to install the hob flush with the work-top surface.

The work-top hole and shaping dimensions are purely guideline; it is essential to refer to your actual ceramic hob before making any cuts.

In the event of a Problem,  
Please Contact Shomar Ltd After Sales at 01 4509150 or  
Email [service@shomar.ie](mailto:service@shomar.ie)

## Contents

Dear Consumer,

Thank you for your purchase of our products. To ensure you use the appliance in the best effect, please read this instruction manual with care before the using, and please save it for later learning.



The manufacturer declines all responsibility for damage to persons or things caused by non-observance of the above prescriptions or by interference with any part of the appliance or by the use of non-original spares.

1. INSTRUCTIONS FOR PROPER USE _____	2
2. SAFETY INSTRUCTIONS _____	3
3. BEFORE USE _____	4
4. COOKING ZONES _____	5
5. DESCRIPTION OF CONTROL ON THE FRONT CONTROL PANEL _____	6
6. USE OF THE COOKING HOB _____	7
7. CLEANING AND MAINTENANCE _____	12
8. SOMETHING WRONG? _____	12
9. INSTALLATION _____	13



**INSTRUCTIONS FOR THE USER:** these contain user advice, description of the commands and the correct procedures for cleaning and maintenance of the appliance.



**INSTRUCTIONS FOR THE INSTALLER:** these are intended for the qualified technician who must install the appliance, set it functioning and carry out an inspection test.



# USER MANUAL

2266RTTC

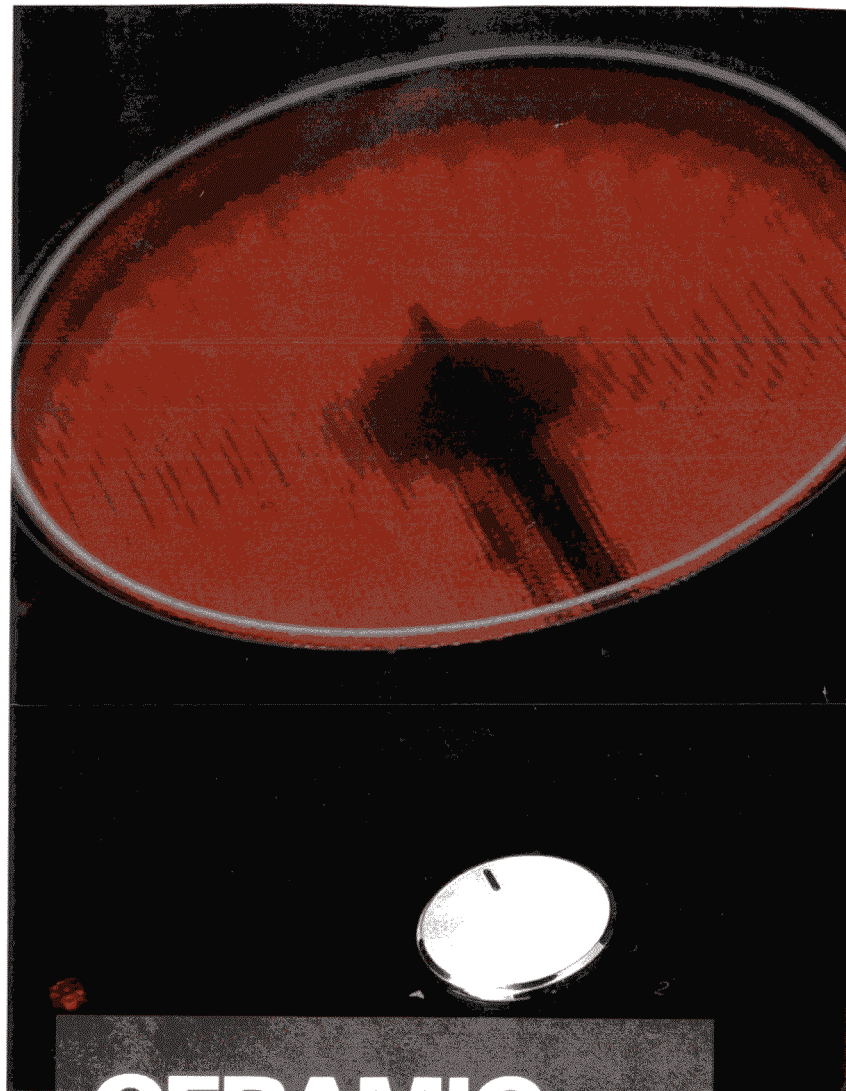

**CERAMIC  
COOKTOP**

Supplied By Shomar htd [www.shomar.ie](http://www.shomar.ie)

