

TOSOT

User Manual

Window Air Conditioner

Before using your TOSOT Window Air Conditioner
please read this user manual in its entirety.

MODEL NUMBERS

8000 BTU: GJC08BS-A6NRNJ1A

10200 BTU: GJC10BR-A6NRNJ1A

12100 BTU: GJC12BR-A6NRNJ1A



Welcome to the TOSOT Direct Family!

We're extremely happy to welcome you as a new member of our family! Please read some helpful tips for your first-time use for your TOSOT product.

Tips for First-Time Use

1. Allow the unit to sit upright for at least 3-4 hours before powering on. Shipping carriers may set the unit on its side, which causes the refrigerant to pool in certain areas. Standing the unit upright for 3-4 hours allows the refrigerant to move freely within the coils.
2. Run the unit continuously for 24 hours after letting the unit to stand upright for 3-4 hours. This allows the unit to work out any "kinks" that may have resulted during shipping from our factory or to your doorstep.
3. If you have any questions, please email us at support@tosotdirect.com before making a return request. Our support team typically replies within 24 hours, usually sooner. If you haven't received a reply, please check your spam or junk folder as sometimes our replies get lost in customer's inboxes!

Table of Contents

Safety and Instructions	01
Installation and Setup	01
Operation	02
Electrical Information	03
Parts	04
Control Panel	05
Display Screen	06
Remote Control	08
Changing the Wind Direction	11
Installation	11
Window Requirements	12
Installation Procedure	13
Adding Foam to Accordion Panels	17
Proposition 65 Notice	18
Cleaning	19
Maintenance Checklists	20
Troubleshooting	21
Malfunction Codes	22
Frequently Asked Questions	23

Safety and Instructions

Please read all instructions before use and save this user manual for future reference. A digital version can be obtained by emailing us at support@tosotdirect.com.

Your safety and the safety of others are very important to us. We have provided many important safety messages throughout this manual and on the appliance itself. Always read and follow all posted safety messages. If you have any doubt, please contact support@tosotdirect.com with any questions.

To reduce the risk of fire, electric shock, injury, or death to persons using or near this appliance, please follow some basic safety precautions. These precautions include, but are not limited to, the following:

Installation and Setup

- This appliance is not intended for use by any persons (including children) with reduced or restricted physical, mental, or sensory capabilities, or lack of experience and knowledge, unless under direct supervision of a person responsible for their safety.
- Please keep plastic bags and sheets out of the reach of children as they might be mistakenly used for play. Packaging materials can become airtight chambers and may pose a risk of suffocation if not disposed of properly.
- This product should be plugged directly into a power outlet. Power outlet should be properly rated, protected, and sized in order to avoid electrical overload. **Do not use a multiple-outlet power strip or extension cord with this window air conditioner.** Failure to do so may result in short-circuit or electrical shock. Do not cut or remove the third (ground) prong from the power cord under any circumstances.
- When installing or moving the appliance, be careful not to pinch, crush, or damage the power cord.
- Never attempt to operate this appliance if it visibly damaged, malfunctioning, disassembled, or has missing or broken parts. This includes exposed wiring on a damaged cord or electrical plugin.
- Do not attempt to disassemble or repair any part of this appliance. All repairs and services must be performed by qualified service personnel.

- Use caution when unpacking and installing as the sharp edges of the unit may cause personal injury.
- It is recommended that two people install and setup the air conditioner to avoid the unit falling out of window.
- Chemicals and other solvents which are dissolved in the air (e.g. cleaning products, hair spray, air fresheners, perfumes, etc.) may cause the product to deform and become damaged.
- Installation must be performed in accordance with national wiring standards by authorized and trained personnel only.
- The outdoor operating temperature range for this unit is 64°F - 109°F (18°C-43°C). Operating this air conditioner outside of this temperature range may cause damage to your air conditioner.

Operation

- To avoid risk of electrical shock, do not grasp the power cord or the unit with wet hands and avoid placing the product where it could be splashed with water.
- Avoid placing the unit itself or any other objects on top of the power cord, including rugs or carpeting.
- Keep air inlet/outlets free from obstruction and clean the filter regularly to ensure optimal and safe performance
- Do not insert fingers or other objects into the air inlet or outlet. Not only is the internal fan running at high speeds, there is also an increased risk of deadly electrical shock.
- Remove the power plug from wall outlet if the product will not be used for extended periods.
- If the product makes a strange noise or emits a strange or smoky smell, immediately remove the power plug and contact customer service for next steps.
- Turn off the product and remove the power plug before cleaning or maintenance. Wait for the fan to stop moving.
- Do not attempt to accelerate the defrosting process other than using instructions contained in this user manual, as this may damage your unit.
- No open fire (e.g. electrical heater or gas stove) should be used on or near the appliance.

- Do not direct airflow directly at room occupants, pets, or plants, as this may negatively impact health.
- Do not use the air conditioner for special use purposes; such as the preservation of precision devices, food, plants, or other irreplaceable objects as it might cause deterioration of quality.
- Always insert filters securely and clean filters every 2 weeks for optimal performance.
- Do not drink water drained from the air conditioner as this may contain contaminants which will make you ill.

Electrical Information

The power supply cord with this air conditioner contains a current detection device designed to reduce the risk of fire. In the event that the power supply cord is damaged, it cannot be repaired. The power supply cord must be replaced with a replacement cord received from the manufacturer by a trained service technician. Please contact support@tosotdirect.com for further details.

- Please ensure that the electrical service in your home is adequate for the model you have chosen. This information can be found on the serial plate, which is located on the side of the unit behind the air intake grille.
- Your air conditioner must be used in a properly grounded wall receptacle. If the wall receptacle you intend to use is not adequately grounded or protected by a time delay fuse or circuit breaker, have a qualified electrician install the proper wall power receptacle before using this appliance.
- Be sure that the air conditioner is properly grounded. To minimize shock and fire hazards, proper grounding is important. The power cord is equipped with a three-prong grounding plug for protection against shock hazards.
- Do not run air conditioner without the white plastic shell in place. This could result in mechanical damage within the air conditioner.
- Do **not** use an extension cord or adapter plug with this air conditioner **under any circumstances**.

To test your power supply cord please do the following:

1. Plug in the air conditioner.
2. The power supply cord will have two buttons on the plug head. If you press the **TEST** button you should notice a clicking noise as the **RESET** button pops out.
3. Press the **RESET** button again, and you will notice a clicking noise as the button engages.
4. The power supply cord is now supplying electricity to the unit.

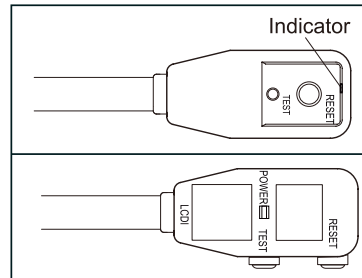

Note: Plug may be different with the actual product. Please refer to actual product.

- Do not use the power supply cord to turn the unit on or off
- Always make sure the **RESET** button is pushed in for correct operation
- The power supply must be replaced if it fails to reset when either the **TEST** button is pushed, or it cannot be reset. Please contact support@tosotdirect.com for more information.

Parts

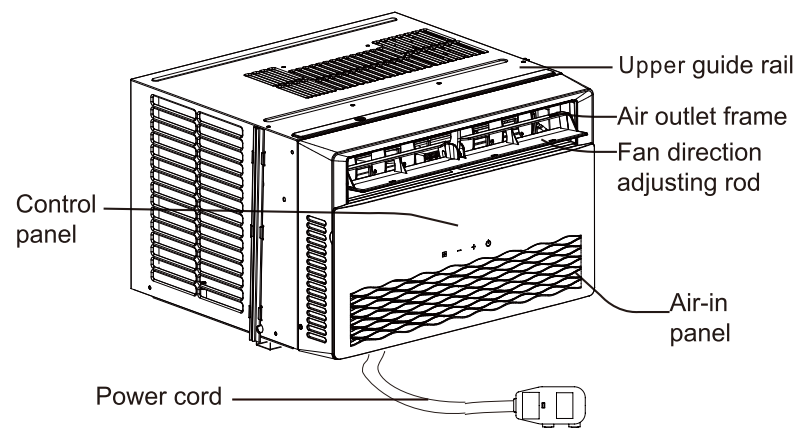

Control Panel

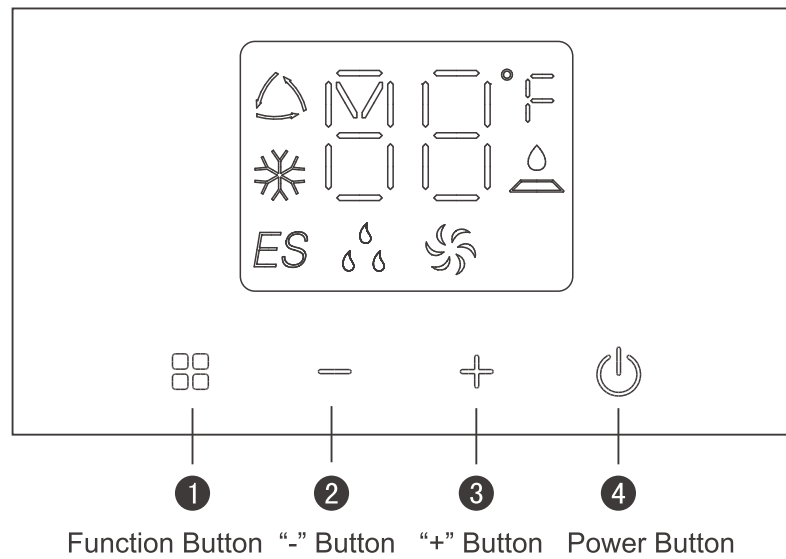

① Function Button

When the unit is in **Auto**, **Energy Saving**, **Dry**, or **Fan** modes, pressing the Function Button once will enter the unit into **Cool** mode. When in **Cool** mode, press the "+" and "-" buttons to adjust to your desired target temperature.

Press the Function Button again to change the fan speed while in cooling mode. Use the "+" and "-" buttons to change between the various fan speed settings: Low (LO), Medium (MI), High (HI), and Auto (AU).

After entering Cool mode, you can not change to a different mode by using the control panel on the unit. You will need to change the mode by using the remote control.

② "-" Button

In the **Cool**, **Energy Saving**, and **Dry** modes: press this button once to decrease the set temperature by 1°F. Press and hold this button for 5 seconds to reset the Clean Filter timer to zero. If the filter cleaning indicator light is on, press and hold for 5 seconds to clear the illuminated Clean Filter icon on the display screen.

③ “+” Button

In the **Cool**, **Energy Saving**, and **Dry** modes: press this button once to increase the set temperature by 1°F.

④ ON/OFF Button

Press to power the air conditioner **ON** or **OFF**. When the unit is powered off the set temperature will be saved until the unit is powered back on. When turning the unit on via the control panel, the unit will operate in **Energy Saving** mode until you change the operating mode using the **FUNCTION** button.

Note: The default temperature reading on the display panel is in degrees Fahrenheit. To change the display to degrees Celsius, press and hold the “+” and “-” buttons together for 3 seconds. Repeat this process to change back to Fahrenheit.

Display Screen

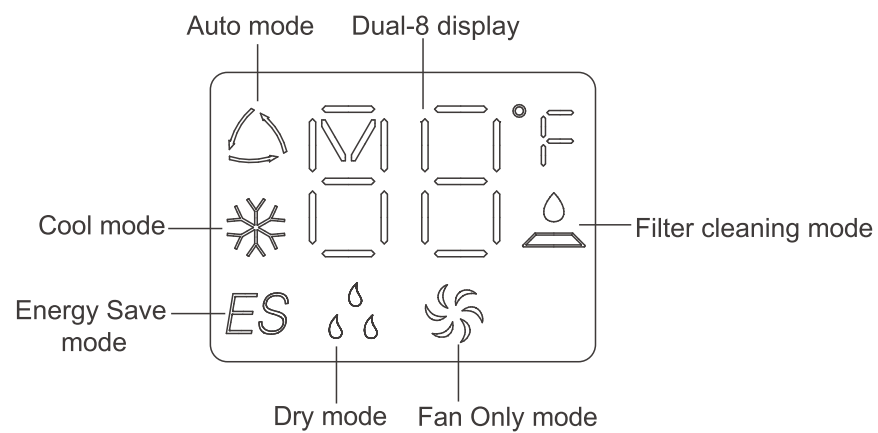

① Auto mode

The air conditioner will operate according to a predetermined factory setting. The set temperature cannot be adjusted in Auto mode. The fan speed can be adjusted.

② Dual-8 Display

The display which will display the set temperature, fan speed, malfunction code, and other important information.

③ Cool mode

Standard cooling mode. The set temperature and fan speed can both be adjusted.

④ Energy Saving mode

An automatic mode to save on energy costs. The fan speed can be adjusted in Energy Saving mode. The set temperature can be adjusted in Energy Saving mode.

⑤ Filter Cleaning mode

After 250 hours of continuous operation, the filter cleaning icon will illuminate to remind you that it is time to clean the filter. After cleaning, press and hold the “-” button for 5 seconds to reset the indicator light and 250-hour timer.

⑥ Dry mode

The unit will run on low speed for dehumidification. The fan speed cannot be adjusted.

⑦ Fan Only mode

The air conditioner will not produce cool air, only blow air from the outside. The fan speed can be adjusted.

Remote Control

This is a universal remote control for a variety of models. If your model does not have a function listed on the remote control, there will be no changes in the operation of your unit. The max range of the remote control is approx. 25 feet with no obstacles or interference from other devices, such as wireless phones or fluorescent lamps.

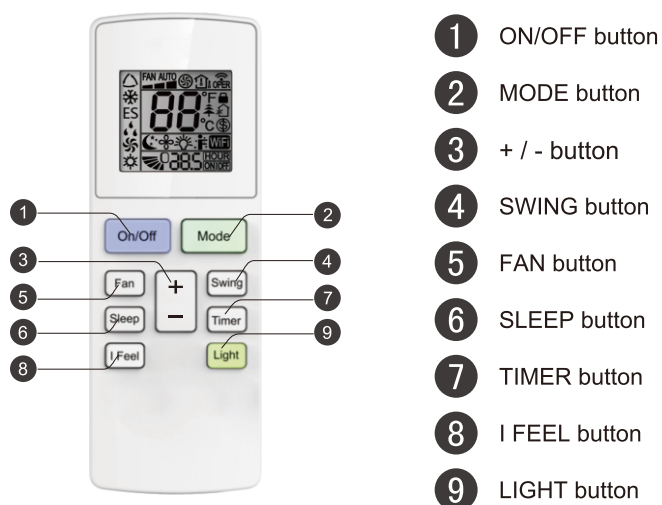

1 On/Off Button

Press to power the air conditioner **ON** or **OFF**. The unit will start in **Energy Saving** mode after first being powered on. When the unit is powered off the set temperature will be saved until the unit is powered back on. In the event of a power outage, the unit will return to the last saved settings before the unit lost power.

2 Mode Button

Press this button to cycle through the five operating modes. A corresponding logo indicator on the left side of the remote will be shown.

- **Auto mode:** The air conditioner will operate according to ex-factory setting. The set temperature cannot be adjusted. The fan speed cannot be adjusted.

- **Cool mode:** Standard cooling mode. The set temperature and fan speed can both be adjusted.
- **Energy Saving mode:** An automatic mode to save on energy costs. The set temperature cannot be adjusted. The fan speed can be adjusted.
- **Dry mode:** The unit will run on low speed for dehumidification. The fan speed cannot be adjusted.
- **Fan Only mode:** The air conditioner will not produce cool air, only blow air from the outside. The fan speed can be adjusted, but you cannot use the "Auto" fan speed setting.

③ +/- Button

- Pressing the "+" or "-" button will increase/decrease the set temperature by 1°F. Holding the button for 2 seconds will cause the temperature to change rapidly. Release the button once your desired temperature is reached.
- After pressing the Timer button, each press of the +/- button will increase/decrease the time by 0.5 hours. Holding the button for 2 seconds will cause the timer to change rapidly. Release the button once your desired time setting has been reached.

④ Swing Button

Press this button to turn the swing feature on or off. When on, the air flow will swing back and forth vertically.

⑤ Fan Button

Press this button to cycle through the Auto mode and 3 fan speeds (Low, Medium, High)

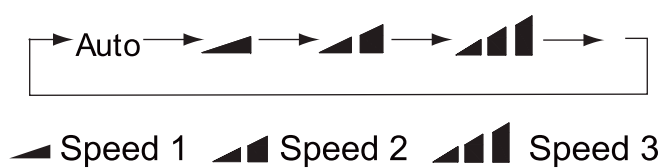

⑥ Sleep Button

Press this button to enter the sleep operation mode. While in sleep mode, you can only use the **Cool**, **Energy Saving**, or **Dry** modes.

7 Timer Button

Press this button to activate the timer button. Use the +/- buttons to adjust the length of the timer before the unit powers off. The time setting range is 0.5-24 hours, in 0.5 hour increments. Press the timer button a second time to confirm the timer setting. If the characters on the display are blinking, you must press the Timer button again to confirm the timer setting. If you have confirmed a time setting, you can press this button again to cancel the timer mode.

8 "I Feel" Button

Pressing this button will use a sensor located in the remote control to determine the temperature setting of your air conditioner. The remote controller will send a temperature update to the air conditioner every 10 minutes for better accuracy in your room. If the air conditioner does not receive an update from the remote control after 11 minutes, it will revert to using a sensor on the air conditioner itself to adjust the temperature settings. In the case of a power outage, this setting will not be saved. You will need to manually reset the I Feel mode after a power outage.

9 Light Button

Press this button to turn off the lights on the display panel of your air conditioner. Press the button again to turn the light back on.

10 Change Between °F and °C

With the remote powered off, press the Mode and "-" buttons simultaneously to switch between Fahrenheit and Celsius displays.

Replacing the Batteries

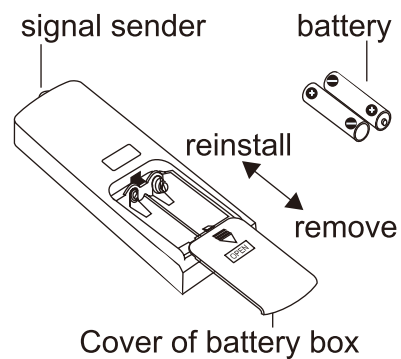

1. Press the back side of the remote control battery cover and slide out following the engraved arrow.
2. Replace with two new AAA (1.5V) batteries of the same make and model. Make sure the polarities (+ & -) are aligned correctly.
3. Reinstall the battery cover box.



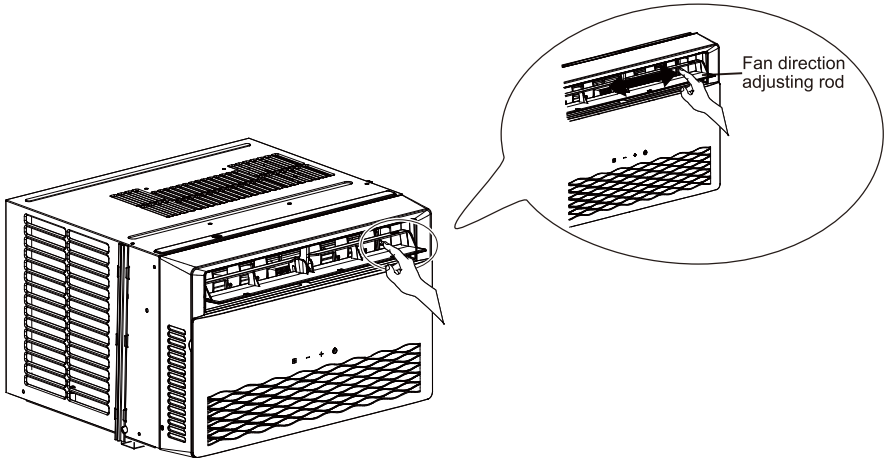

Changing the Wind Direction





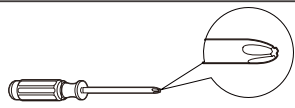
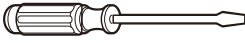

Move the adjusting rod with your fingers to change the wind direction from left to right. There are two separate sections that you can adjust to point each in different directions.

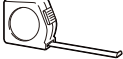

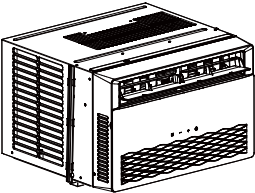
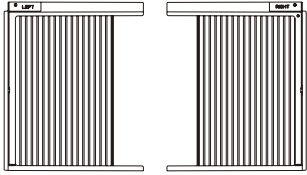

You can adjust the vertical angle of the wind speed by using the “Swing” button on your remote control.

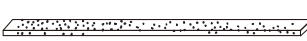
Installation

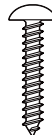
Tools				
	Phillips-head screwdriver		Flat-blade screwdriver	
				
	Level	Scissors or knife	Pencil	Ruler or tape measure

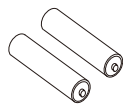
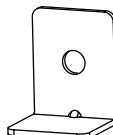
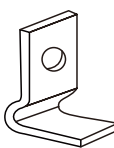
Spare parts list		
	Air conditioner	Left and right accordion panel
		
	Window sill and sash seal (2)	Top mounting rail
		
	Foam top window gasket	Top mounting rail seal strip
		
Accordion panel seal (2)	Foam Insulation (2)	Type B screws(6)

Spare parts list					
	Remote controller	Batteries	Window locking bracket	Frame locking bracket (2) is only included on 10k/12/ models.	Type A screws(4)

Window Requirements

The instructions outlined below are for standard, vertical-sliding windows. If you have a different window type (e.g. horizontal-sliding window) you may need to choose a different window or use a different installation procedure.

If you are installing this air conditioner in a smaller window, you may not need the accordion subassembly. Please refer to the window size requirements for more details.

In some cases, you may need to put a small wooden block under the air conditioner to ensure that the unit is not tilting towards the inside of your home. If the unit is tilted towards the inside of your home, water may drain into your home and damage the window frame, wall, or flooring. A slight angle of 5° is all it takes to ensure that water does not drain into your home.

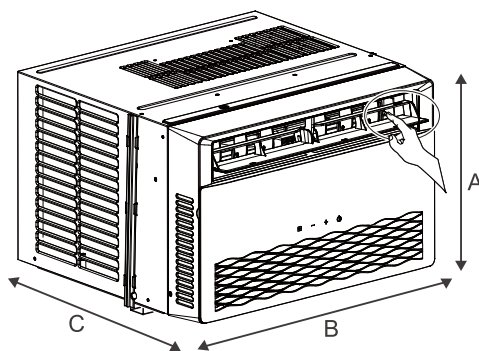

Label		8000 BTU	10200 BTU	12100 BTU
A	AC Unit Height	12.8"	15.8"	15.8"
B	AC Unit Width	21"	21.4"	21.4"
C	AC Unit Depth	17.2"	22.8"	22.8"
-	AC Unit Weight	52.9 lbs	65 lbs	71.7 lbs

Installation Procedure

Step 1: Install the top mounting rail

1. Remove the adhesive from the top mounting rail seal strip. Align strip to the four (4) holes and stick to the side of the mounting rail which attaches to your air conditioner.

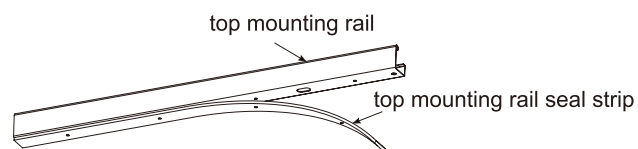

2. Use four (4) included Type A screws to fix the top mounting rail to the outer case of the air conditioner. The flat edge with a single hole in the middle should be facing towards you.

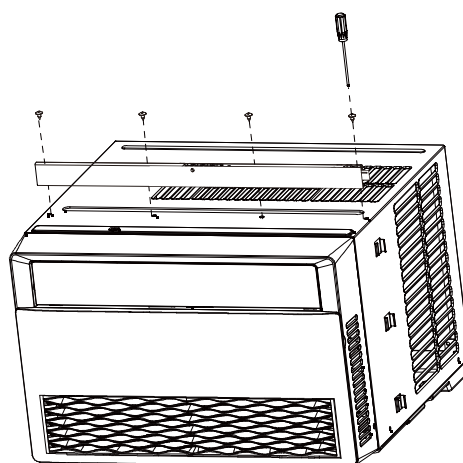

Step 2: Install accordion panels

1. Remove the accordion panel seal from the paper backing. With the LEFT and RIGHT text visible, apply the panel seal as shown in the figure below.

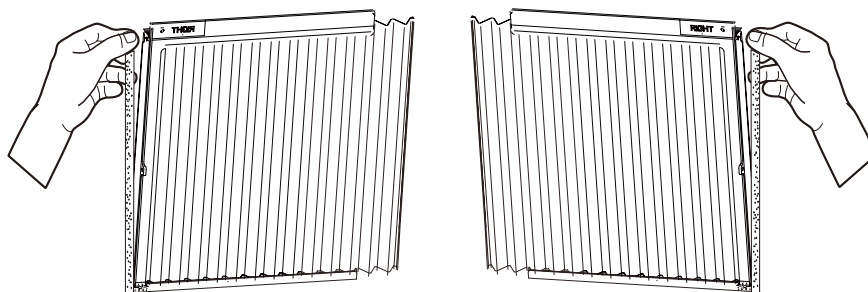

2. With the LEFT and RIGHT text facing towards you, pull the accordion panel towards the unit. Align the end of the accordion panel with plastic groove on the unit and slide to bottom. Slide the plastic framing of the accordion panel into the top mounting rail and the lower guide rail.

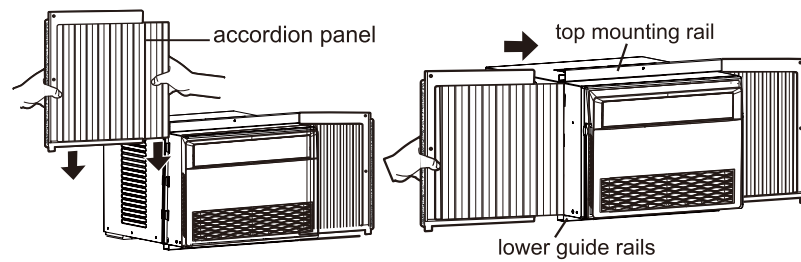

Step 3: Attach the window sill seal and sash seals

1. Cut the window sill and sash seal strips to proper length. Tear off the paper backing and stick to the lowest part of the window sill. Repeat for the top of sliding window.

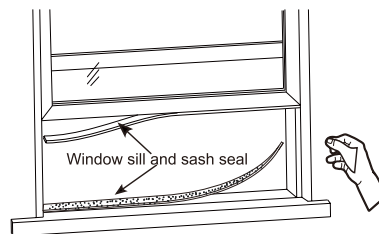

Step 4: Install the air conditioner unit

1. With two people, align the lower guide rail to the edge of the window sill. After placing, close the window so that the top mounting rail is aligned with the inside edge of the window.

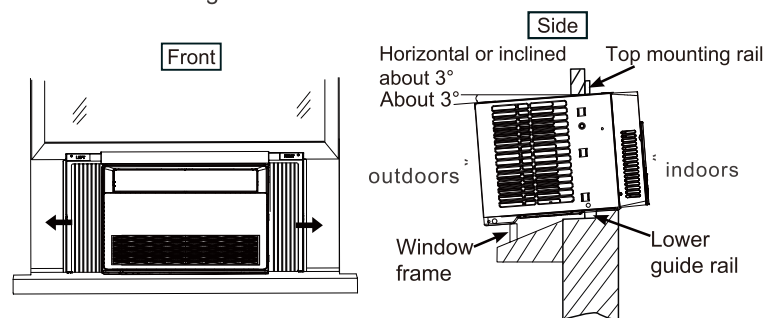

2. Unfold the accordion panels from both sides. Use five (5) included Type B screws to fix the frame of the accordion panel to the window frame and window sill. There are three (3) predrilled holes on the top. Use the two (2) included frame locking brackets to secure the bottom of the accordion panel to the window sill.

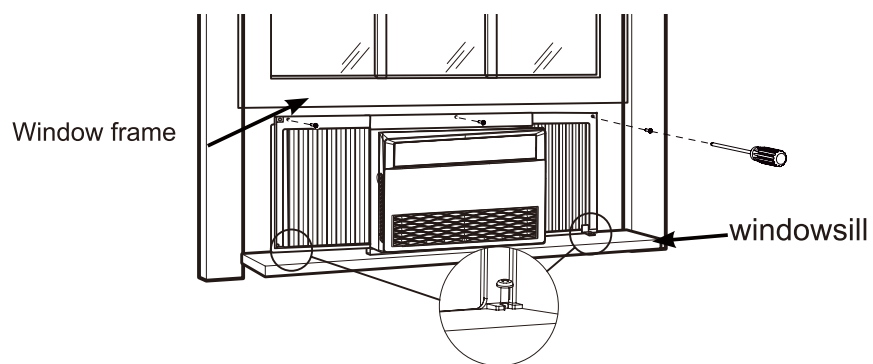

Step 5: Install the window locking bracket

1. To keep the unit from falling out the window, secure the window locking bracket once the window is resting against the top mounting rail.

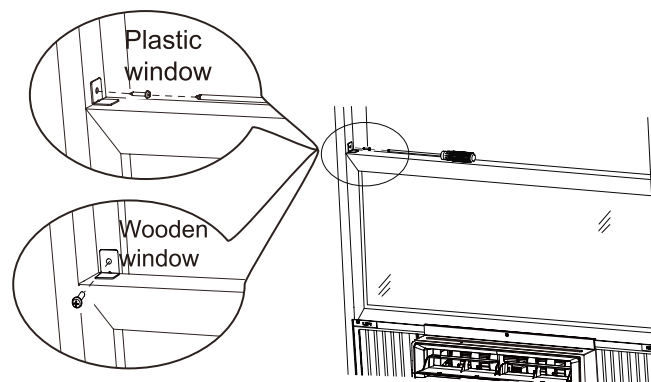

Step 6: Plug the gap of the top window with foam

1. Cut foam top window gasket to the proper length. Use this to plug the gap between the windows to prevent rain or insects from getting into the room.

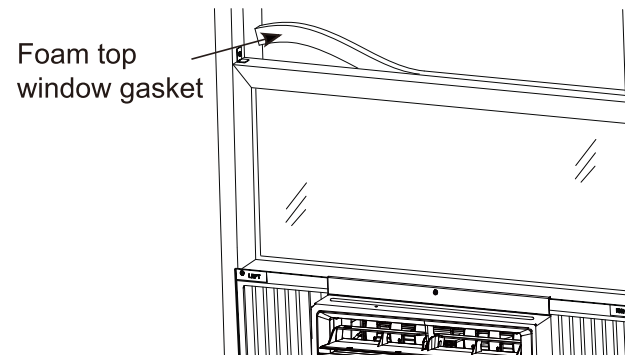

Adding Foam to Accordion Panels

1. After completing installation of your unit, measure the length between the air conditioner and the edge of the window frame.

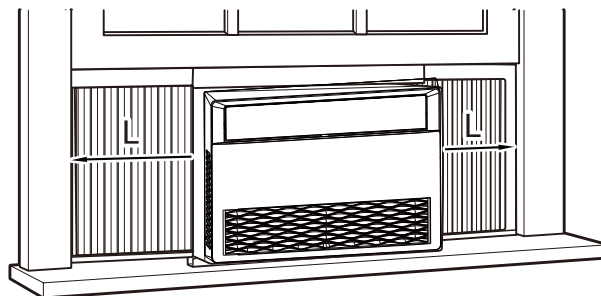

2. Cut the included foam insulation to length.

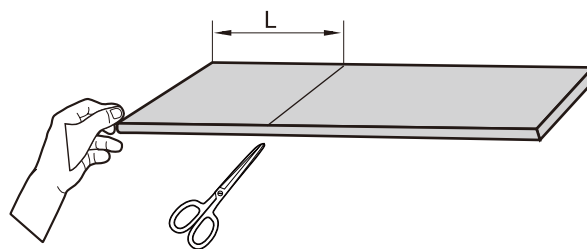

3. Cut the included foam insulation to length.

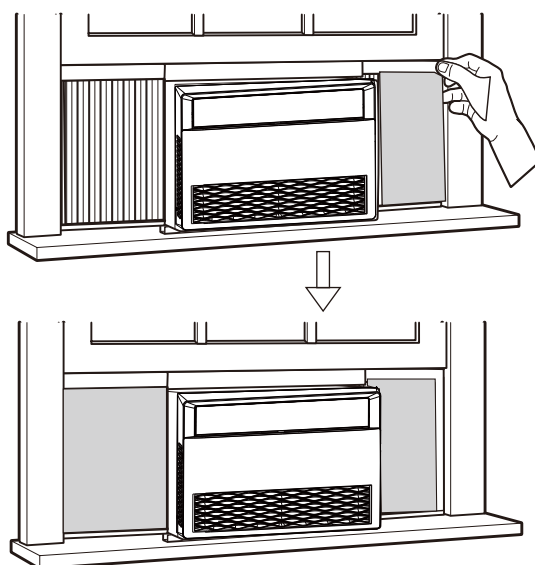

Proposition 65 Notice

California Safe Drinking Water and Toxic Enforcement Act of 1986 requires us to notify customers that this product contains chemicals known to the State of California to cause cancer and birth defects or other reproductive harm. Please wash hands after finishing installation of this product.



Cleaning

To avoid electric shock, turn off the air conditioner and disconnect from power before cleaning. Do not wash or douse the air conditioner with water. Do not use volatile liquids to clean the air conditioner.

Cleaning the filter

1. Open the front panel

Locate the groove on either side of the front panel and pull towards you as shown in the figure on the right. Some force may be required.

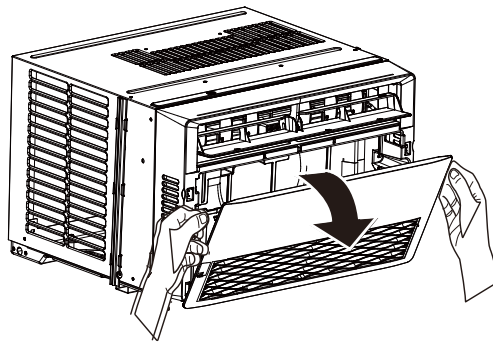

2. Remove the filter

Locate the filter and remove from the air conditioner. You may need to move the filter around to loosen.

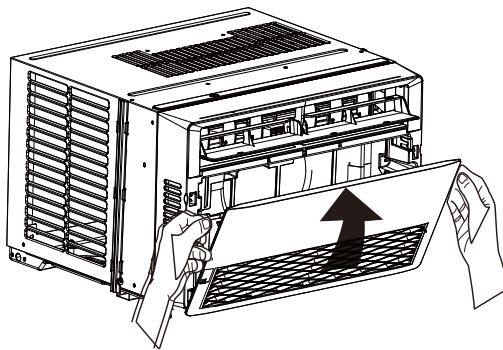

3. Clean the filter

After removing, use the dust attachment of your vacuum or warm water mixed with a mild detergent.

4. Reinstall the filter

After the filter has dried completely, reinstall back into the air conditioner.

Notes:

- Clean the filter every three months, or once the filter indicator light illuminates on your air conditioner.
- Do not touch the metal fins in the air conditioner after removing the filter, as they may cause personal injury.
- Do not attempt to dry the filter with hair dryer or other heating element as this may deform or ignite the filter.
- Do not operate the air conditioner if the air filter is missing.

Cleaning the display panel

If the surface of the panel is dirty, please wipe with a soft cloth soaked in warm water and a mild detergent. Do not remove the plastic panel to clean.

Cleaning the outer case

We recommend that you check the outer case of the air conditioner once or twice per year to look for rust or other damage. In order to reduce damage and prevent rust during offseason months, you can cover the air conditioner with plastic or other protective covering.

Maintenance Checklists

Pre-Season Maintenance Checklist

- Check the power cord for any cuts or exposed wiring
- Check the ground prong is still on your power plug
- Clean the air filter
- Check the outer air grille for damage

Post-Season Maintenance Checklist

- Disconnect unit from power outlet
- Clean air filter and exterior case
- If keeping in window during winter, wrap with protective cover

Long-Term Storage Checklist

- Disconnect unit from power outlet
- Clean air filter and exterior case
- Wrap and/or cover the unit to prevent the accumulation of dust within the unit

Troubleshooting

Not all of the following problems are malfunctions.

Problem	Possible Causes
Air conditioner is not operating. Controls cannot be set	<ul style="list-style-type: none"> • Not a high enough voltage supplied from your wall power outlet • Power plug is loose or in TEST mode
Temperature cannot be changed	<ul style="list-style-type: none"> • The temperature cannot be adjusted while in auto mode or fan-only mode • You are trying to exceed the temperature range of 61-86 °F
Noise suddenly rises during operation	<ul style="list-style-type: none"> • Might be some interference from storm or radio • Compressor has just powered on • Unit is not firmly placed in your window
Room temperature does not drop	<ul style="list-style-type: none"> • Air filter is dirty • Close doors and windows in the room
When first operating, the air emitted has a strange odor	<ul style="list-style-type: none"> • This is normal when the unit just starts operation. Give it some time and the smell will disappear
Air conditioner is giving off some weird noises	<ul style="list-style-type: none"> • Normal sounds from the refrigerant flowing inside the air conditioner • Panel may have shrunk/expanded due to the temperature changing rapidly
Air conditioner cannot receive signal from the remote control	<ul style="list-style-type: none"> • Out of the 25 foot range • Interference from radio, fluorescent lamp, or other source • Batteries are low in remote controller

Malfunction Codes

If your unit displays one of the following codes, please contact support@tosotdirect.com and let us know your Malfunction Code from the display screen. Please fill out the product registration form on our site for faster service.

Malfunction Code on Unit	Malfunction Name	Symptoms	Solution
F1/F2/F4	Indoor ambient temperature sensor	Compressor stops operation, but the fan continues to operate.	<p>Remove from power source for a few minutes to reset the unit. Plug the unit back in to determine if the Malfunction Code is still present.</p> <p>If that doesn't work, contact TOSOT support via email at support@tosotdirect.com</p>
E2	Antifreeze Protection	In Cool, Energy-Saving, or Dry modes: the compressor stops operating but fan continues to run.	
E8	Overload Malfunction	Indoor fan operates while compressor, outdoor fan, and water condensation tray stop operation.	
H3	System Overload Protection	Compressor stops operation, but the fan continues to operate.	
F0	Refrigerant Lacking Protection	Compressor stops operation, but the fan continues to operate.	

Frequently Asked Questions

Can I leave this unit installed all winter

You can. Leaving the unit installed during the winter will not harm your unit. Just make sure that your unit is unplugged once the temperature starts to drop. If you attempt to power the unit on when the outside temperature is below 60°F it may damage the internal components of your air conditioner.

How do I know this unit will fit in my window?

Below you will find a chart with the minimum and maximum window dimensions for each type of unit.

	8000 BTU	10200 BTU	12100 BTU
Minimum Window Height	13.25"	18"	18"
Minimum Window Width	25"	25"	25"
Maximum Window Width	40"	40"	40"
Minimum Depth	17.3"	22.8"	22.8"

Warranty & Customer Support

Warranty Information

1. 1-Year warranty:

TOSOT Window Air Conditioners come with a 1-year warranty from the date of purchase.

This warranty covers manufacturing and material defects. Please visit <https://tosotdirect.com/warranty> for more terms&policy.

2. Additional 6-Month warranty extension:

You can get a 6-month warranty extension by registering your new product at www.tosotdirect.com/extend and answering a short questionnaire.

Customer Support

Questions? We are here to help

✉ support@tosotdirect.com

☎ 1-844-888-6768

🌐 www.tosotdirect.com



Share your experience



@tosotdirect