



We Are Dispensers

Tape Dispensers

Wire Harnessing

VHB Application

APPLIANCE

PACKAGING

Non-Adhesive Cutters

Product ID

SOLAR & WIND POWER

Battery Manufacturing

Parts Assembly

FOOD & BEVERAGE

RFID

Label Dispensers

Barcodes

Promotional Labels

pharmaceutical

Safety Seal

AUTOMOTIVE

MANUFACTURING

Die-Cut Gaskets

ELECTRONICS

Heat Shrink Tubing

ZCM2000/M2200 Series



START International

4270 Airborn Drive, Addison, TX 75001, U.S.A.

Tel 1.972.248.1999 • Fax 1.972.248.1991 • service@STARTInternational.com

www.STARTInternational.com



CONTENTS

Read this user’s manual before use to ensure proper operation. Keep the manual on hand for reference in case there is a problem.

| | |
|----------------------------------------|------------|
| Warrenty/Repair Policy | Page 2 |
| Notice | Page 3 |
| Warning | Page 4 |
| Description of Control Panel Functions | Page 5-7 |
| Operation | Page 8-12 |
| Maintenance | Page 13-15 |
| Exploded Views/Parts Breakdown | Page 16 |

WARRANTY POLICY FOR LD SERIES LABEL DISPENSERS

START International warrants all parts on ZCM series tape dispensers against defects in design, materials and workmanship for a period of 360 days. Parts excluded from this are: cutting blades, silicone rollers and cutter liners; these parts are considered “wear parts”. Labor to replace defective parts will be performed at no charge for the first 180 days after date of purchase. Warranty does not cover transportation costs.

START International’s sole obligation under this warranty is limited to repair, replacement or credit of the purchase price, at our option, which do not properly perform the function for which they were designed.

Warranty repair is contingent upon START’s examination and determination that alleged defects have not been caused by misuse, abuse, improper installation or application, repair, alteration, accident or neglect in use, storage, transportation or handling.

The above warranty and remedy constitutes START International’s sole liability hereunder and are in lieu and exclusive of all other warranties and remedies expressed, implied, or statutory, including, but not limited to, those of merchantability and fitness for a particular purpose.

REPAIR POLICY

Contact START INTERNATIONAL to determine nature of problem.

Furnish START with the following information:

1. Who the unit was purchased from.
2. Model number and serial number.
3. Date purchased (copy of invoice or packing slip required).

START will issue an RMA (Return Material Authorization) for the repair. Return machine to START by freight, insured and prepaid. START will notify the customer if there is a repair charge. A \$25.00 evaluation charge will apply to all non-warranty repairs, which will be applied to repair change.

For the full Warranty & Repair policy please visit www.STARTInternational.com

NOTICE

This instruction manual is for START International Tape Dispensers, models No.: zcM 1000, zcM2000, zcM 1100 and zcM2200. Refer to the following comparison chart for model differences:

PRODUCT COMPARISON

- Keep strip plate free of adhesive build-up.
- Clean photosensor with compressed air or dry cloth.
- Do not drop the dispenser or subject it to heavy shock.
- Turn off machine when not in use.

1.1 Product Comparison

| Model No. | zcM1000 | zcM2000 | zcM1100 | zcM2200 |
|------------------------|---------|---------|---------|---------|
| Automatic feed and cut | ● | ● | ● | ● |
| 3 Length memory | — | ● | — | ● |
| Safety cutter | — | — | ● | ● |

Refer to page 9 for details of length memory. **2000 2200**

Refer to page 7 for details of safety shutter. **1100 2200**

 **WARNING**

Do NOT insert your fingers into cutting head.



WARNING

⚠ Caution

Do NOT place anything flammable in or on the unit.

Do NOT use the unit on an unsteady surface.

Do NOT use the unit in humid or dusty environment.

Do NOT disassemble or modify the tape dispenser.

Make sure to unplug the unit when moving it or replacing parts.

Do NOT insert bars or plates into the tape outlet. This will damage blades.

Do NOT drop the unit or subject it to heavy shocks.

Do NOT use volatile liquids (thinner, benzene, etc.) to clean the unit. Wipe with dry cloths only.

Do NOT use damaged cable. This may cause a fire or electric failure.

Do NOT use the unit near volatile liquid.

Do NOT use power other than the set voltage labeled on the machine. (110-117V or 220 – 240V)

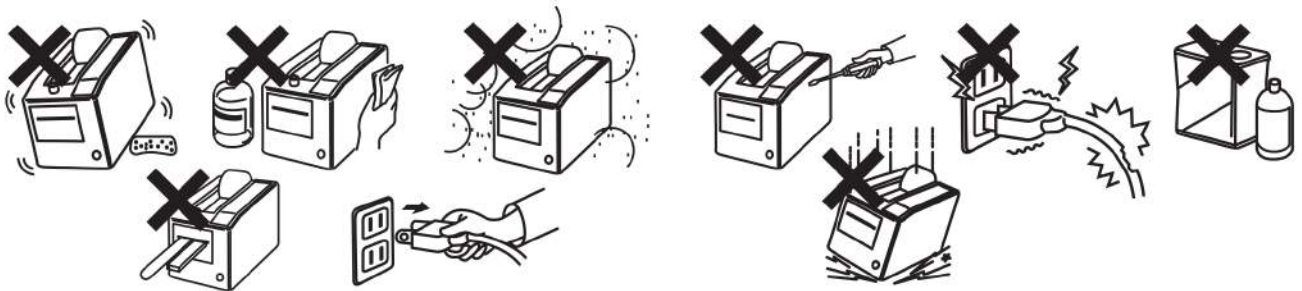

DESCRIPTION OF CONTROL PANEL FUNCTIONS

zcM1000 / zcM2000

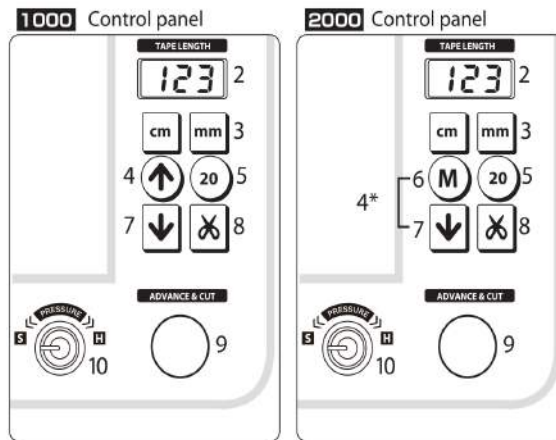
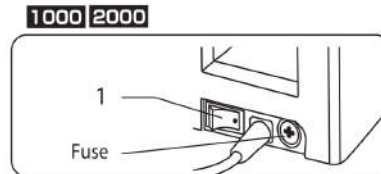
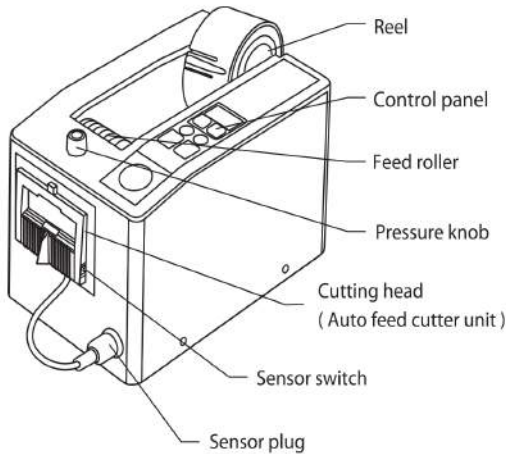



| | |
|-------------------------|-------------------------------------------------------------------------------------------------------------------------------------------------------------------------------------------------|
| 1 Power switch | Press to turn power ON or OFF. |
| 2 Tape length display | Shows tape length and errors. |
| 3 Length adjustment key | The last digit indicates "mm" (0 - 9mm) and the first two digits "cm" (20 - 990mm). |
| 4 Reverse key | 1000 Feed roller reverses by pressing ↑ . Use this key for changing tape. ----- 2000 Feed roller reverses by pressing M + ↓ . Use this key for changing tape. |
| 5 20(reset)key | Resets length display reset and back to min set length of 20mm. |
| 6 Memory key | 2000 Press and hold until the LED display flashes to save memory. Saved lengths are selected by short pressing of this key. |
| 7 Feed key | Tape dispenses as long as ↓ is pressed. |
| 8 Cut key | Press ✂ to cut tape. |
| 9 Auto Key | Press AUTO to feed tape to the preset length and cuts automatically. |
| 10 Pressure knob | Adjusts (top) roller to change pressure on tape. |

DESCRIPTION OF CONTROL PANEL FUNCTIONS (CONT'D)

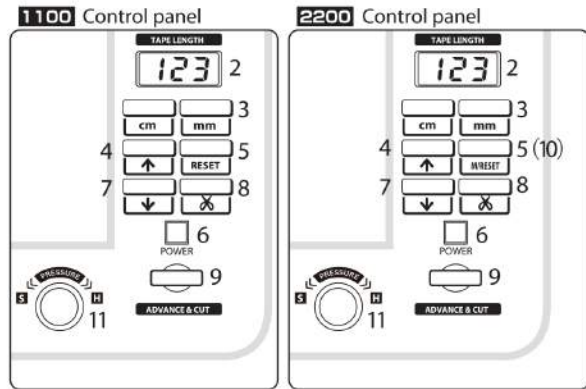
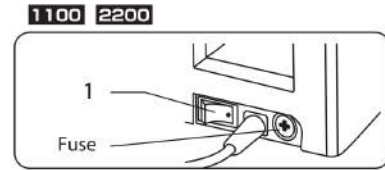
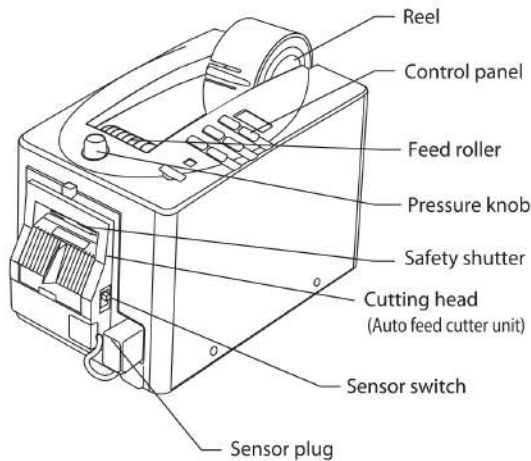
zcM1100 / zcM2200



| | |
|-------------------------------------------|--------------------------------------------------------------------------------------------------------------------------------------------------------|
| 1 Power switch | Press to turn power ON or OFF |
| 2 Tape length display | Shows tape length and errors. |
| Length adjustment key | The last digit indicates "mm" (0-9mm) and the first two digits "cm" (30 – 990mm). mm + cm : Back to min set length of 30mm |
| 4 Reverse key | Feed roller reverses by pressing  . Use this key for changing tape. |
| 5 Reset key (M/RESET for 2200) | RESET Clear error by pressing this key twice. |
| 6 Power LED | <input type="checkbox"/> Lamp is lit when the power is turned ON. |
| 7 Feed key | Tape dispenses as long as  is pressed. |
| 8 Cut key | Press  to cut tape. |
| 9 Auto Key | Press AUTO to feed tape to the preset length and cuts automatically. |
| 10 Memory key | 2200 M/RESET Press and hold until the LED display flashes to save memory. Saved lengths can be checked by short presses of this key. |
| 11 Pressure knob | Adjusts (top) roller to change pressure on tape. |

OPERATION

Setting up

| | |
|-------------------------------------------------------------------------------------------------------|---------------------------------------------------------------------|
|  Attention | <p>Make sure power and sensor switches are OFF to ensure safety</p> |
|-------------------------------------------------------------------------------------------------------|---------------------------------------------------------------------|

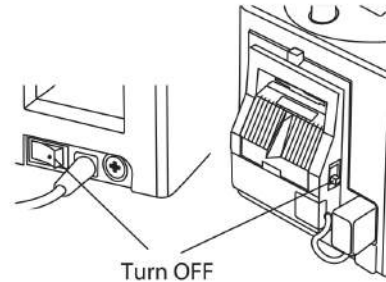

- ① Plug sensor plug into the unit.
- ② Plug power cord in.
- ③ Turn the power switch ON.

1000 2000

Min set length of 20 will be shown on the LED display.

LED display



1100 2200

Min set length of 30 will be shown on the LED display.

LED display

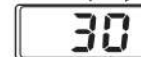

Loading tape

- ① Remove the reel from the unit.
Load tape on the reel and place it back in the unit.
- ② Make sure to position the tape on the center of the reel.
- ③ Fold corners of the tape to form a trapezoid shape (Fig.). Stick the tape onto metal feed roller.
- ④ Press "↓" until tape feeds through cutting head.

(Fig.) Fold tape back

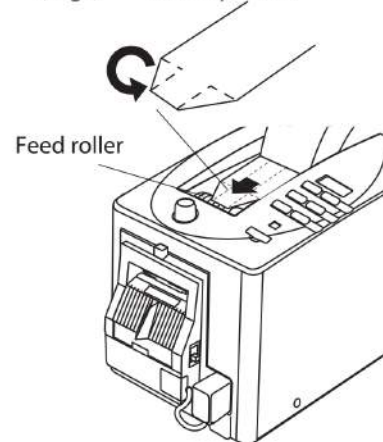

OPERATION

- ⑤ Adjust "Pressure knob" in accordance with tape.
 - If tape curls up or slips, increase pressure. (Turn Clockwise)
 - If tape creases, decrease pressure. (Turn Counter-clockwise)
- ⑥ Advance 3cm – 4cm of the tape out from the cutting head.
- ⑦ Press "✂" to cut the tape.
- ⑧ Remove tape

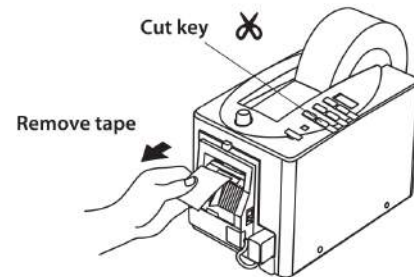

Setting tape length

Make sure sensor switch is OFF.

Press "mm" and "cm" for setting length.

- ① Press "mm" to set length of 0-9mm(Last digit)
- ② Press "cm" to set length of **1000 2000** 20 -990mm / **1100 2200** 30 -990mm.(First two digits)

* Keep pressing button for quick change.

* Last setting length is saved even when main power is turned OFF.

LED display

20

↓ mm

27

↓

27

↓ cm

457

Resetting saved length

1000 2000 Press "20" to reset and back to min set length of 20mm.

20

1100 2200 Press "mm + cm" to reset and back to min set length of 30mm.

30

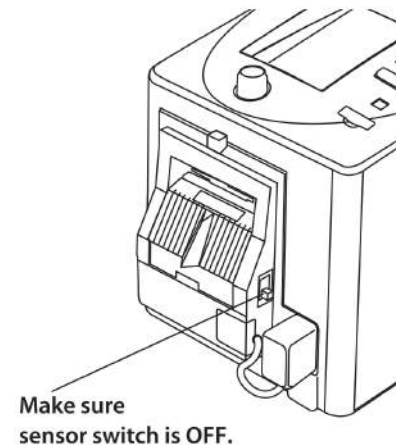

OPERATION

Using automatic feed

- ① Turn sensor switch located on cutting head to ON.
- ② Tape will be fed at a set length and cut.
- ③ Remove a piece of tape from machine.
- ④ Another piece will be fed and cut.

Remove a piece of tape

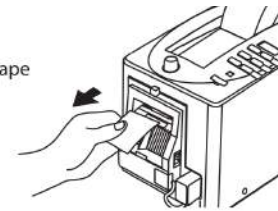

Automatically set length is fed and cut

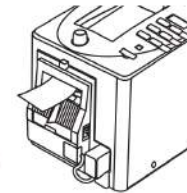

Using manual feed

- ① Turn sensor switch OFF.
- ② Press "**ADVANCE & CUT**" **1000** or "**AUTO**" **2000 1100 2200**
- ③ Whenever "**ADVANCE & CUT/AUTO**" is pressed, set length is fed and cut.

Press "Advance & Cut" or "Auto" key

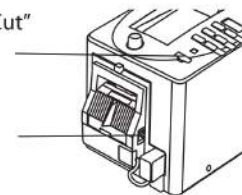

Turn sensor switch OFF.

Safety shutter (Safety device) **1100 2200**

The Safety Shutter System prevents activation of cutter when foreign objects are present.

- When safety device is activated, error (**E r r**) is shown on the LED display.
- "**- - -**" error will be shown, if any keys are pressed while display shows "**E r r**" error.
- No safety shutter for **1000** and **2000** .

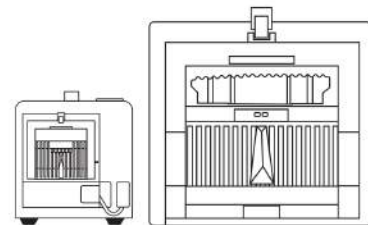

safety shutter activated

How to release "**E r r**" "**- - -**" error **1100 2200**

- ① Remove cutting head from the unit.
- ② Remove jammed tape.
- ③ Move shutter and cutter by tool and back them to the right position(Fig.).
- ④ Press "**RESET**" (1st press)
- ⑤ LED display shows length.
- ⑥ Press "**RESET**" again. (2nd press)
- ⑦ Error will be released.
 - Ask distributor or START International if error cannot be cleared.

(Fig.)

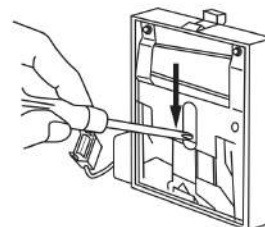

OPERATION

Changing tape

- ① Turn sensor switch OFF.
- ② Press "↑" to reverse tape.
2000 " M " + " ↓ "

The feed roller will rewind the tape away from cutter area.

- ③ Remove whole reel from the unit and replace tape.

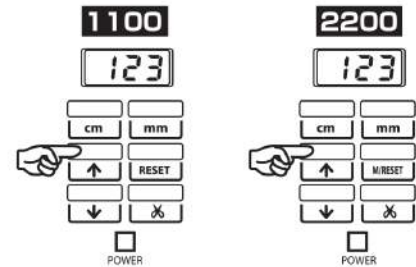
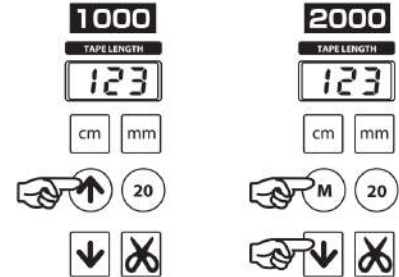

How to remove jammed tape

- ① Press "↑" to reverse tape.
 " M " + " ↓ " for reverse. **2000**
 - Hold the tape and wind it backward slightly as per (Fig.).
- ② Remove tape from metal roller.
- ③ Cut wrinkled part of tape.
 - **In case of heavy tape jam.**
 - ① Remove cutting head from the unit.
 - ② Cut wrinkled part of tape.
 - ③ Remove jammed tape with tweezers.
 - Cut any tape wrapped around rollers with scissors. Take care to avoid damaging rollers.
 - **If tape is jammed in the cutting head.**
 - ① Remove cutting head from the unit.
 - ② Check the gap of the blade on the back.
 - ③ Remove jammed tape with tweezers.
 - If heavily jammed, cutter spring needs to be removed. See page 12 for details.

(Fig.) Wind the tape backward slightly

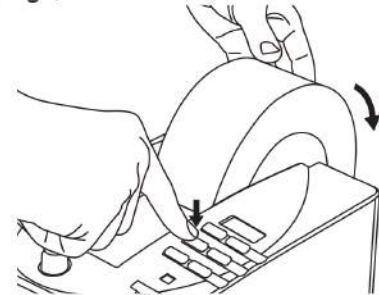

OPERATION

| | |
|------------------------------------------------------------------------------------------------|--------------------------------------------------|
|  Attention | Make sure sensor switch is OFF to ensure safety. |
|------------------------------------------------------------------------------------------------|--------------------------------------------------|

Length memory function **2000 2200**

Set preset lengths and select a mode.

3 different lengths can be saved, and 2 different modes are selectable.

Preset mode (on " 0 ")

On " 0 ", the machine will feed and cut the first set length until the " M " is pressed, then it will feed the second length until the " M " is pressed, and so on.

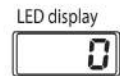

Loop mode (on " 5 ")

On " 5 ", the machine will feed and cut the recorded length in series.

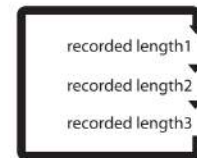
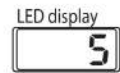

STEP.1 Save lengths

2000 Press and hold "M" (" " for **2200**) until the LED display starts flashing.

- Flashing LED display = Setting mode



1st preset length (Memory 1)

Press "mm" , " cm " and set the desired length for **memory 1**.

2000 Press " M " (for **2200**) to record length for **memory 1**.

Recorded Length 1 e.g. length 50mm

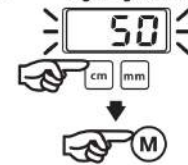

2nd preset length (Memory 2)

Press "mm" , " cm " and set the desired length for **memory 2**.

2000 Press " M " (for **2200**) to record length for **memory 2**.



- If 2nd preset length is not needed, leave " 999 " and

2000 press " M " (for **2200**).

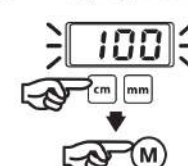

Recorded Length 2 e.g. length 100mm



OPERATION

| | |
|-----------------------------------------------------------------------------------------------------------------------------------------------------------------------------------------------------------------------------------|---------------------------------------------------------------------------------------------------------------------------------------|
| <p>3rd preset length (Memory 3)</p> <p>Press " mm " , " cm " and set the desired length for memory 3.</p> <ul style="list-style-type: none"> • If 3rd preset length is not needed, leave " 999 " . | <p>Recorded Length 3 e.g. length 300mm</p>  |
| <p>2000 Press " M " ( for 2200) to save all programmed lengths.</p> <p>Then "0" will be shown on the LED display.</p> |  |

STEP 2 Mode Selection

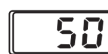
| Preset Mode : On " 0 " | Loop Mode : On " 5 " |
|----------------------------------------------------------------------------------------------------------------------------------------------------------------------------------------------------------------------------------------------------------------------------------------------------------------------------|----------------------------------------------------------------------------------------------------------------------------------------------------------------------------------------------------------------------------------------------------------------------------------------------------------------------------------------------------------------------------------------|
| <p>2000 Press and hold " M " ("  " for 2200) until the LED display stops flashing.</p> <p>1st preset length will be shown.</p>  | <p>Press " mm " . And " 0 " will be turned to " 5 " .</p> <p>2000 Press and hold " M " ("  " for 2200) until the LED display stops flashing.</p> <p>1st preset length will be shown.</p>  |
| <p style="text-align: center;">↓</p> <p>"Preset Mode" settings are complete.</p> | <p style="text-align: center;">↓</p> <p>"Loop Mode" settings are complete.</p> |

Changing saved preset lengths

- Change all



2000 Press " 20 " to reset all settings.





- 2200**
1. Turn the main power OFF.
 2. Turn the main power ON while keep pressing "  " resets all settings.



- Change preset length **memory 1 and memory 2** **2000 2200**

- ① **2000** Press and hold " M " ("  " for **2200**) until the LED display **starts flashing**.
- ② **2000** Press " M " ("  " for **2200**) to choose length preset you'd like to change.
- ③ Press " mm " " cm " keys to change length.
- ④ **2000** Press and hold " M " ("  " for **2200**) until the LED display **stops flashing**. 1st preset length will be shown and complete changing preset length.

MAINTENANCE

| | |
|--------------------------------------------------------------------------------------------------|----------------------------------------------------------------------------------------------|
|  Caution | For safety reasons, make sure to unplug power cord from power outlet before any maintenance. |
|  Caution | Do NOT touch cutter/blade! |

Replacing separating roller unit

Rubber rings on "Separating roller unit" are consumable parts. (ZCM1000P138 or ZCM1000P138-1) Regular replacement is required to maintain satisfactory feeding operation.

- ① Remove cutting head.
- ② Unscrew ① and ② .
- ③ Pinch centre of separating roller unit and pull it out. (ZCM1000P533 or ZCM1000P533-1)
- ④ Replace with new unit.

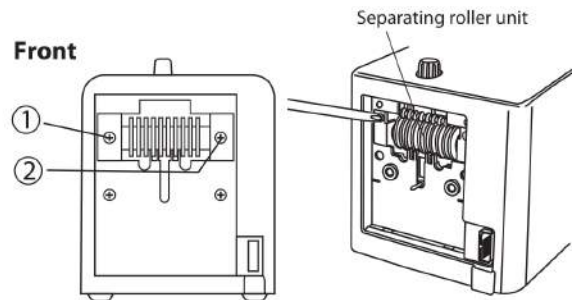
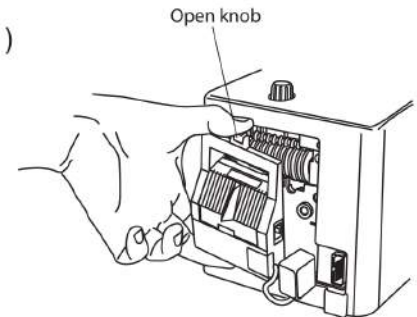

Maintenance of cutter blades

Although a special coating is applied to the cutter/blade, adhesive will build up eventually.

In order to maintain satisfactory feeding operation, remove accumulated adhesive regularly. Use alcohol for removal. Then use enclosed "silicone oil" to minimize glue adhesive up.

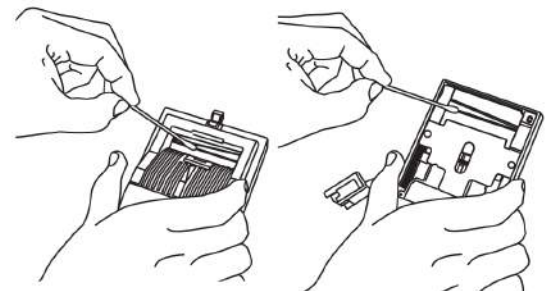

MAINTENANCE

| | |
|--------------------------------------------------------------------------------------------------|--------------------------------------------------|
|  Caution | Pay extra attention when replacing cutter/blade! |
|--------------------------------------------------------------------------------------------------|--------------------------------------------------|

Replacing cutter/blade and cutter liner

Cutter and cutter liner are consumable parts. Regular replacement of cutting head, cutter blades, and individual liners are required to maintain satisfactory cutting operation.

① Remove cutting head.

② Turn 2 screws and remove cutter spring.

| |
|------------------------------------------------------------------------------------------------------|
|  Attention |
| Hold cutter spring in place when unscrewing to prevent injuries due to loose parts. |

③ Remove cutter/blade.

④ Note the direction of the cutter/blade and replace cutter liners if necessary.

⑤ Replace cutter/blade.

⑥ Place cutter spring back into assembly.

⑦ Secure cutter spring by tightening the 2 screws.

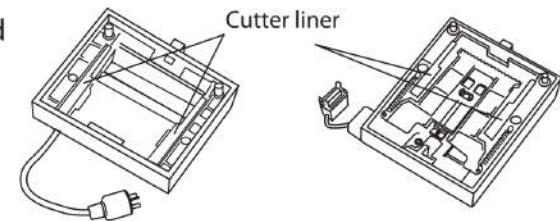
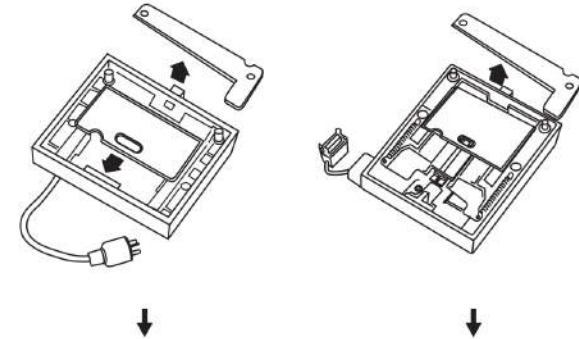
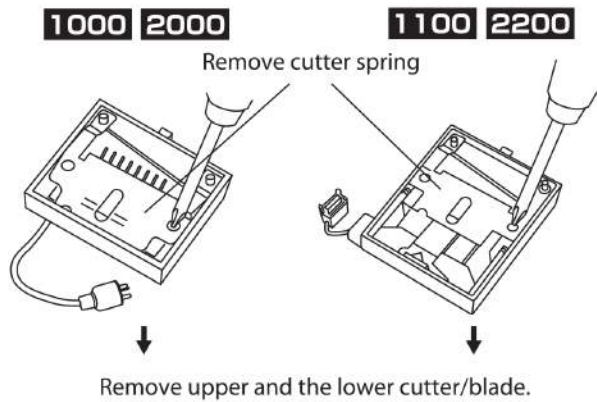

Make sure to position the cutter/blade in the proper direction.

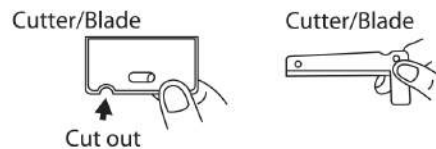

MAINTENANCE

Replacing fuse

- ① Turn main power OFF and unplug power cord.
- ② Turn fuse holder lid to counter clockwise with Phillips screwdriver.
- ③ Replace fuse.
- ④ Put fuse holder lid back and tighten by turning clockwise with screw driver.

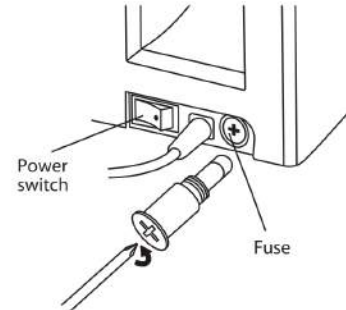

SPECIFICATIONS

| Model No. | zcM1000 | zcM2000 | zcM1100 | zcM2200 |
|--------------------------|------------------------------------------------------------------------------------------------------------------------------------------------------------------------------------------------------------------------------------------------------------------------------------------------------------------|---------------|--------------------------|---------------|
| Display | 3 digit LED | | | |
| Applicable Tape Width | 7 - 50mm (.28" - 2") * "Magnetic Tape Guide" as an option is suggested for 7 - 30mm width tape. (ZCM1000P024) | | | |
| Cut Length | 20 - 999mm (.78" - 39") | | 30 - 999mm (1.2" - 39") | |
| Core (Reel) Diameter | 3-in-1 reel (25mm, 35mm, 76mm) (1", 1.4", 3") | | | |
| Max Outside Dia. of Tape | φ170mm (Larger reel stand is available as an optional part) (ZCM1000P026) | | | |
| Usable Tapes | Cellophane, Kraft, Cloth, PP, Double-sided, Filament, Creped, etc. * Machine may experience difficulty feeding or cutting tapes with the following characteristics: curling, strong adhesive, black color, high transparency, extremely thin, slippery, static generating and other uncommon characteristics. | | | |
| Drive | DC motor for tape feeding and cutting | | | |
| Power Consumption | 18W | | | |
| Power (AC) | 110 - 117V 50/60Hz or 220 - 240V 50 / 60Hz | | | |
| Ambient Light | Fluorescent: 3,000 lx or less (About 30cm under 40W) Incandescent: 800 lx or less (About 45cm under 60W) Sunlight: 10,000 lx or less (Do not operate in direct sunlight) | | | |
| Ambient Temp & Humidity | 5°C - 40°C, 80% Humidity or less | | | |
| Size (W x L x H) | 137×245×156mm | 137×245×156mm | 137×249×156mm | 137×249×156mm |
| Weight | About 2.4kg (5.3 lbs) | | About 2.5kg (5.5 lbs) | |
| Cabinet Material | ABS V-O | | ABS plastic | |

* Accuracy of cut is about ±2mm (depending on tape).

* Specifications are subject to change without notice.

EXPLODED PARTS DRAWING - ZCM 1000 & ZCM2000

