

C30

INTERACTIVE USER MANUAL



TAP TO ENTER MENU





INTERACTIVE PDF

This user manual covers everything you need to know about your C30

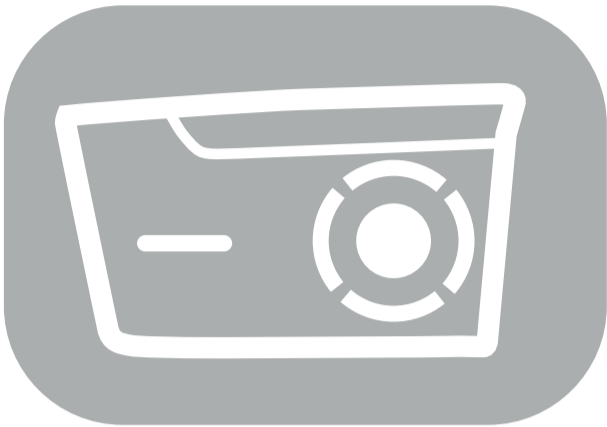

About C30



Installation Steps



Getting Started

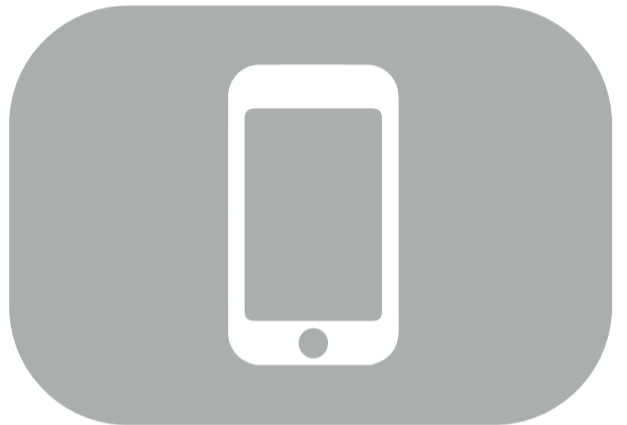

Phone Usage



Intercom Usage



Audio/Voice Experience



Settings & FAQs



MENU



About C30

Congratulations on purchasing your C30



TAP

01



Overview

02

Product parts

03

What's in the box?

PREV



NEXT



MENU



About C30



01 - Overview

The C30 device is a helmet accessory that enables a connected ecosystem where you as a rider can stay connected with your smartphone and other riders over a range of wireless profiles.

You can now use your phone's calling, music, audio and navigation services via the headset. You also have the ability to invoke your phone's voice assistant to make complete use of its value while riding your two-wheeler.

Enjoy the pleasures of a connected riding experience with the **RIDEGRID™** (mesh) intercom

Let's go through everything you need to start using the device.

PREV



NEXT



MENU



About C30

02 - Product parts

Labelled parts of the C30 main unit

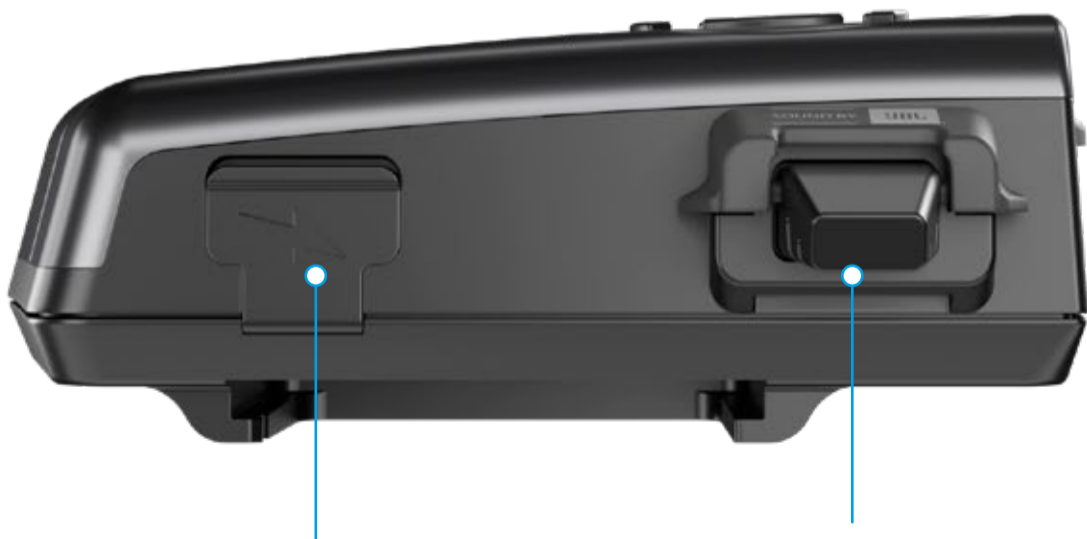
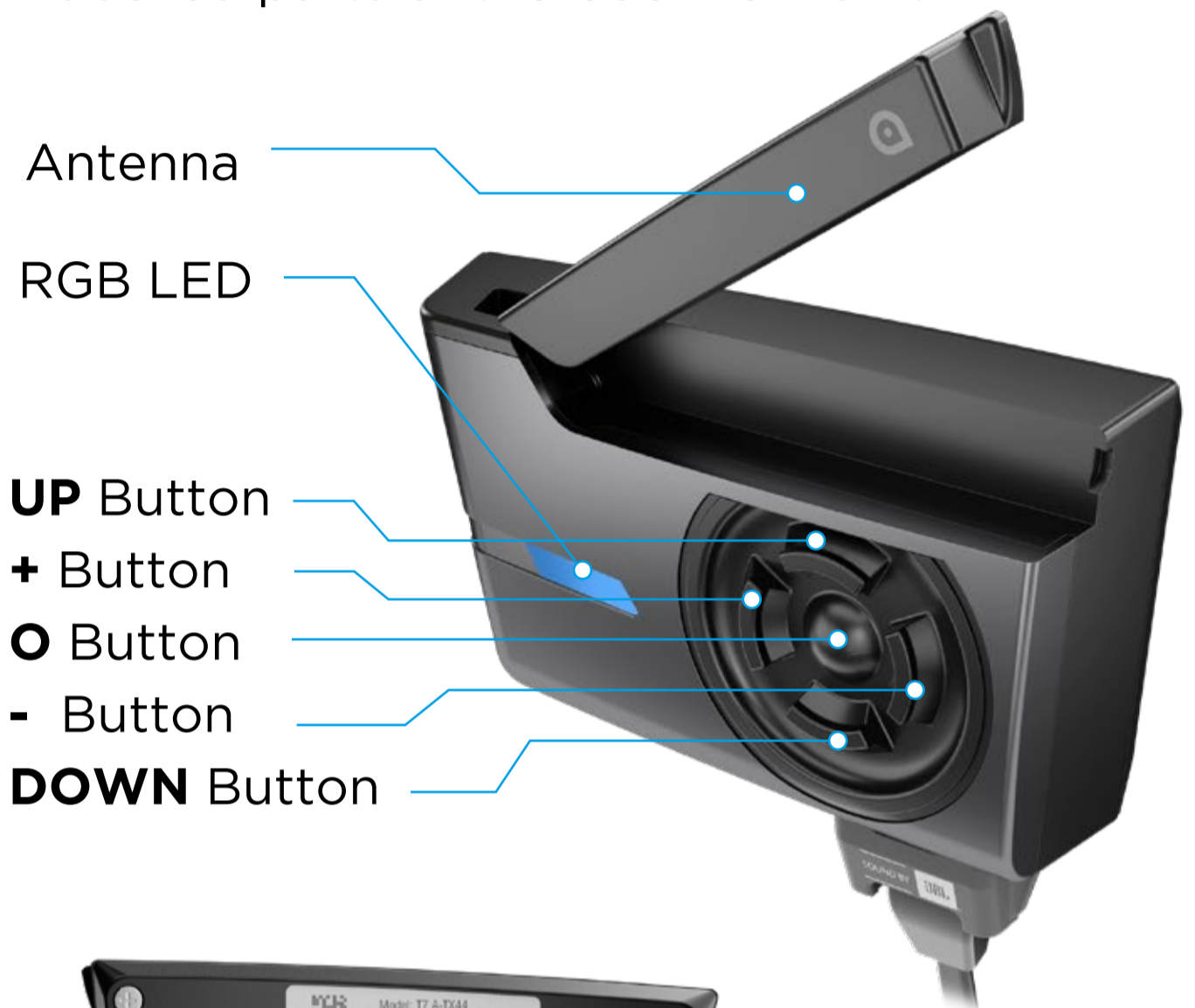

TYPE C
USB Charging
port

MicroUSB
Headset port

PREV



NEXT



MENU



About C30

03 - What's in the box?

List of parts for C30



1) Main Unit

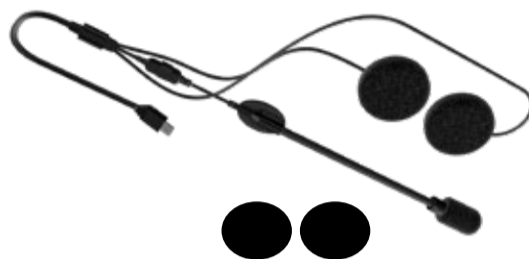

2) Headset Kit +
velcro sticker pads



3) Type C - Charging cable



4) Clamp mount Kit



5) Adhesive mount



6) Speaker Spacers

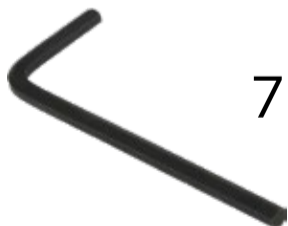

7) Allen key - M3

The companion app is also
required for best experience.



PREV



NEXT



MENU



Installation
Steps

Installation Steps



01

Installation Overview

02

Headset kit placement

03

Installing the Unit

04

Clamp Installation method

05

Adhesive mount method

06

Connecting the Unit

07

Antenna operation

PREV



NEXT



MENU



Installation
Steps

01 - Installation Overview

There are two parts to installing the Device on the helmet

- 1) Installing the Headset kit
- 2) Installing the C30 Communication device

The C30 can be installed on full face, half face or modular helmets.

Note - Please spend a few minutes reading the instructions before you start the installation process. You need to consider the headset kit's wiring and available length before you decide the final position for the device.

PREV



NEXT



Installation
Steps

02 - Headset kit placement

Before you install the headset, you need to remove the helmet inner padding to reveal the speaker slots.

Note: Most helmets provide a speaker slot. If your helmet does not have a speaker slot, you will need to push the ear-piece into place on the EPS (Thermocol) layer.

Speakers (+ spacers)



Take the helmet speakers along with the velcro stickers and locate the slots provided inside the helmet. Attach the sticker first and then attach the speakers. You can use the additional spacers to ensure the speakers are both centered and close enough to your ears. You can adjust this position later when you test the audio output.

Microphone



Run the boom mic along the left inner surface of the chin bar and adjust it such that the mic is close to your mouth. You can adjust the flexible stem of the mic to suit your comfort.

PREV



NEXT



MENU



Installation
Steps

03 - Installing the Unit

The unit has two methods to attach it to the helmet. To decide which method is best, you will need to look at the surface and structure of the helmet you plan to attach it to.

The clamp provided is the recommended method and is suitable for most helmets and can be easily installed and removed.

If your helmet does not accommodate the clamp to be placed between the shell and padding space due to either a thick beading strip or some other helmet specific feature, then you can opt to use the adhesive mount.



Clamp Mount

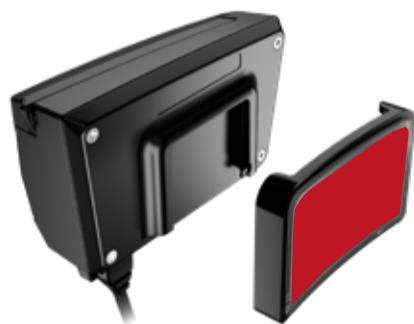

Adhesive Mount

PREV



NEXT



MENU



Installation
Steps

04 - Clamp Installation method

Start by placing the helmet on its side such that the left side of the helmet is facing you.

a) Loosen the allen screws on the Clamp and slide it between the helmet outer shell and inner padding.

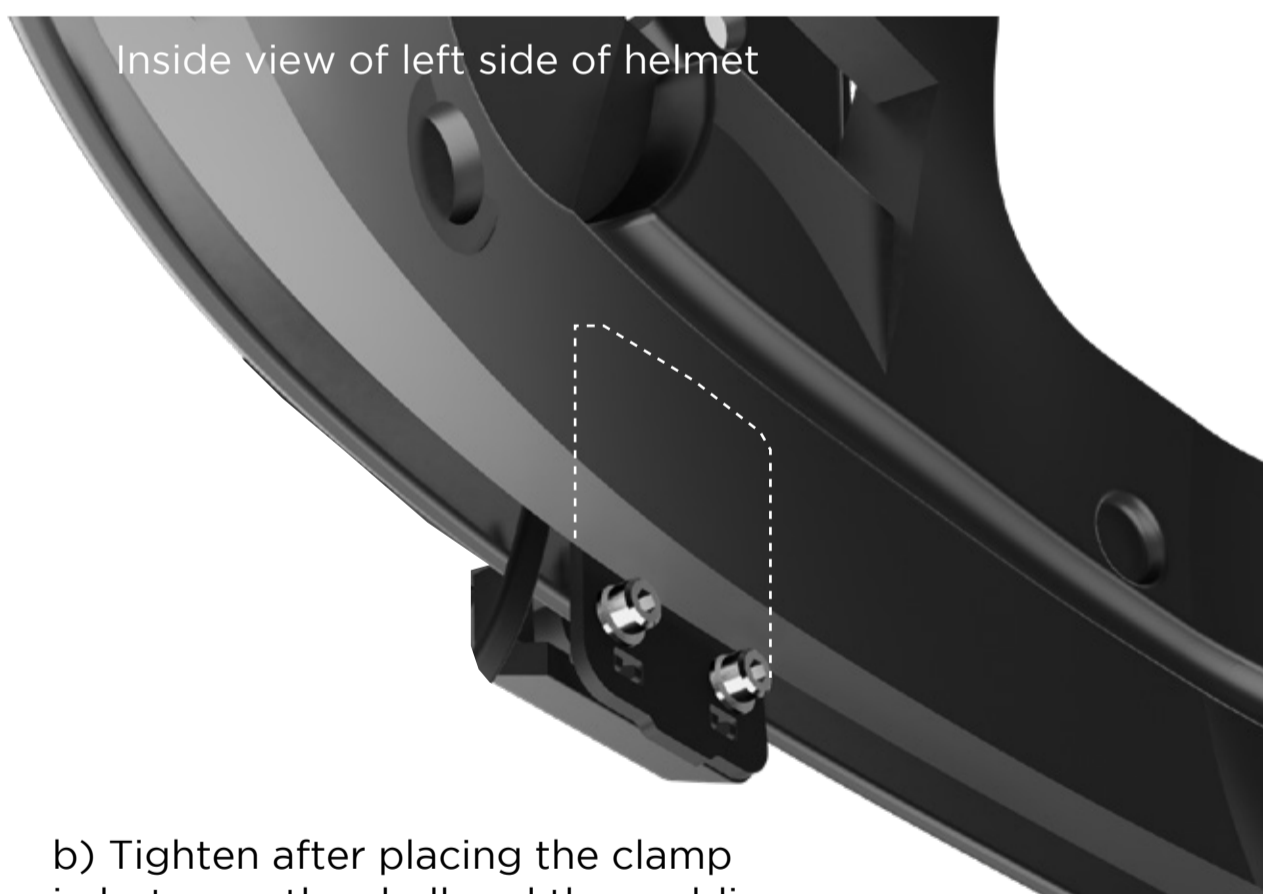
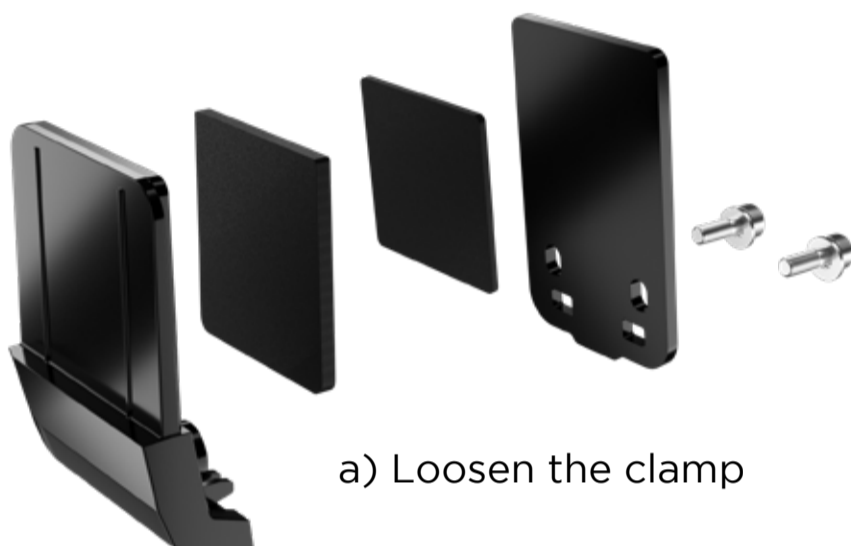

b) Now tighten the allen screws, don't tighten fully as you will need to move it a bit to suit the headset cable length. Check if your helmet requires the use of extra foam pads to be placed between the clamps to help fit it securely.

PREV



NEXT



MENU



Installation
Steps

05 - Adhesive mount method

This method is the optional choice if you are unable to place the clamp securely on your helmet.

Ensure before you start that you clean the surface of the helmet well to remove all dust and dirt, as this will compromise the adhesion process.

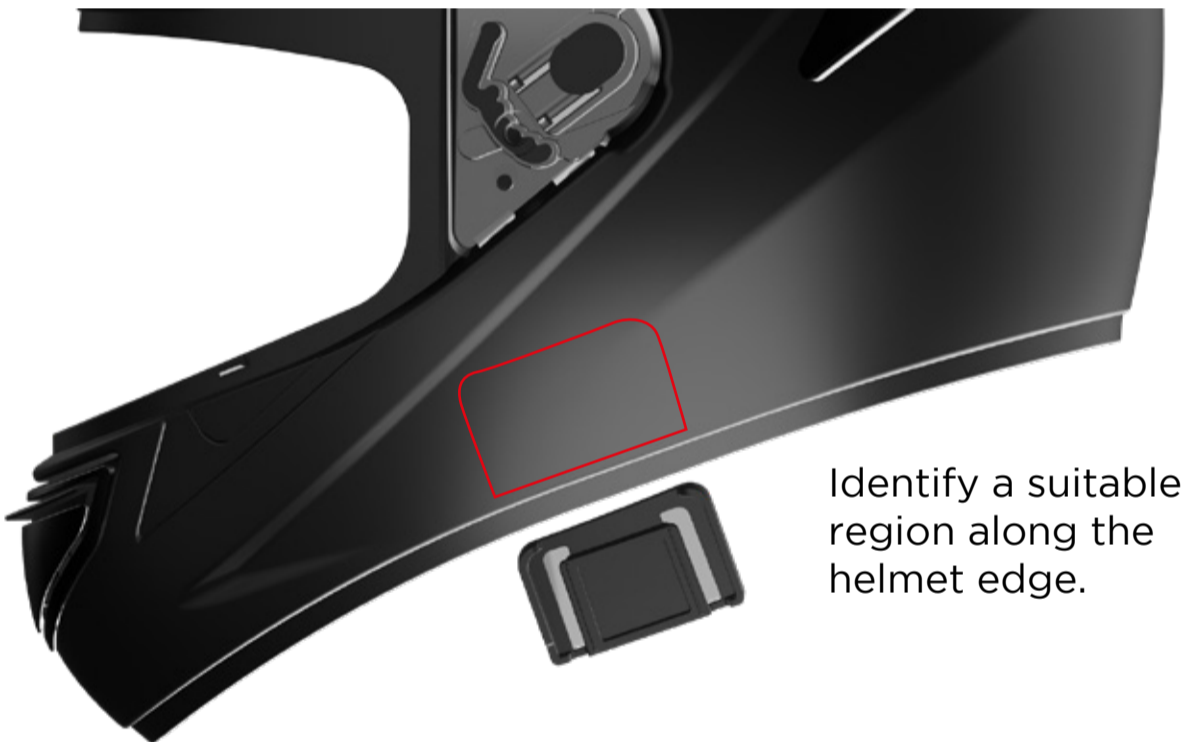

Use the bottom edge of the helmet as a reference and try to find a surface on the left side of the helmet that is best suited for the mount's adhesion.

Ensure this spot on the helmet is in complete contact with the 3M VHB sticker (which is on the back of the mount).

When choosing mount location also confirm the cable reaches the device.

PREV



NEXT



MENU



Installation
Steps

06 - Connecting the Unit

Slide device into place



Now you are ready to attach the unit to mount. Simply slide it from the top aligning the slots of the device and the mount till the device clicks firmly in place. The procedure is the same for both mounts.

Connecting Headset micro USB + safety lock



a) Connect micro USB



b) Secure the safety lock

The micro USB end of the headset can now be attached to the unit, which is located on the right bottom edge. Once inserted, secure the safety lock in place to ensure the lock is positive and secure. The lock minimizes stress on the cable and protects it from accidental snag or tug.

PREV



NEXT



MENU



Installation
Steps

07 - Antenna operation

Active (open) and Passive (closed) states

The antenna on the unit can be opened by nudging it outwards. The antenna will spring into active (open) state. Press it back to the passive (closed) state and it will slide and click back into place.



a) Nudge antenna outwards



b) Antenna will spring out

For best intercom experience ensure the antenna is in Active (open) state. You can close it if you aren't using the intercom.

PREV



NEXT



MENU



Getting Started

Getting Started

Steps to charge and power up



01

Charging the device

02

Buttons and functions

03

Powering ON/OFF

04

Pairing device to phone

05

Connect App

06

OTA firmware update

07

Pairing to 2nd phone

PREV



NEXT



Getting Started

01 - Charging the device

USB Type C port

The device is charged via the USB Type C port on the bottom-left side of the unit. Open the dust protection hood and secure the connection.

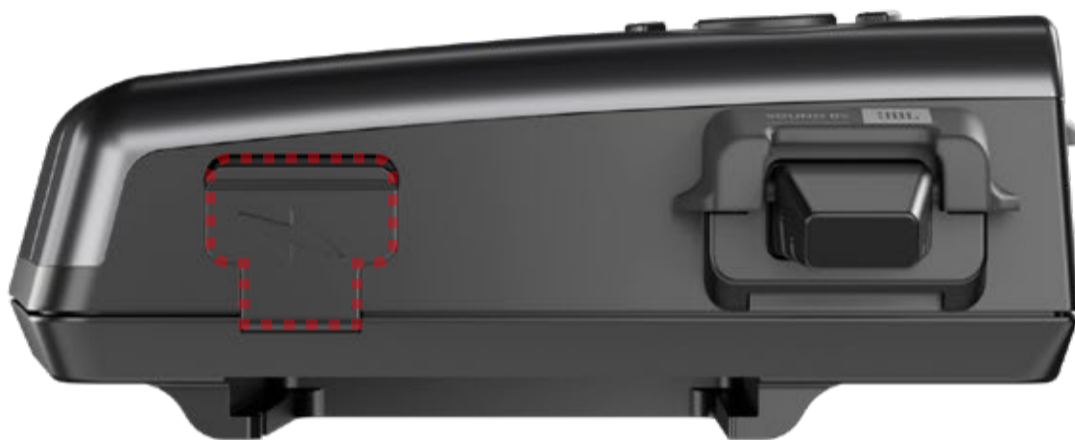

a) Open USB hood

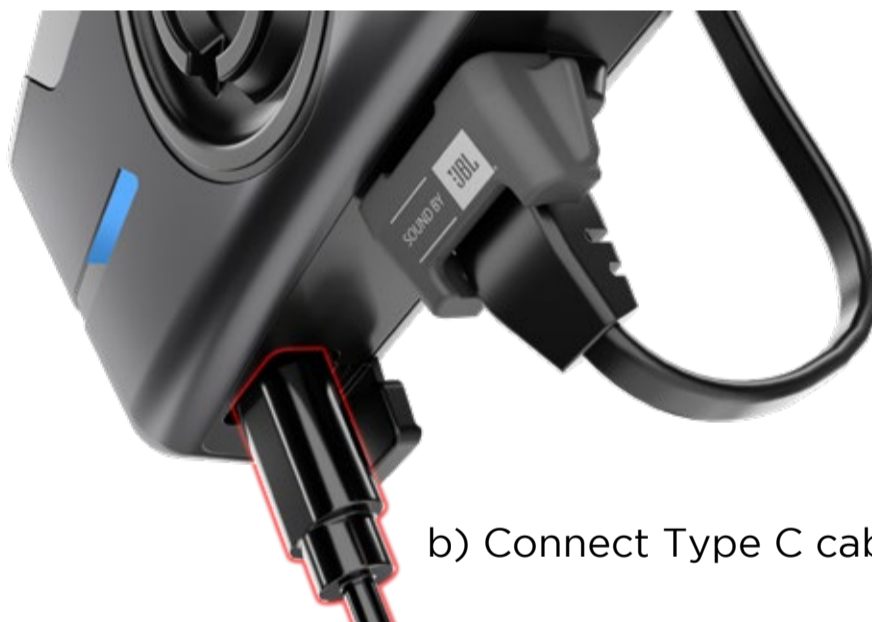

b) Connect Type C cable

The LEDs light up in the following colors/pattern to indicate the charge level during charging.



< 10%



10 - 40%



40 - 70%



70 - 95%



> 95%

PREV



NEXT



Getting Started

02 - Buttons and functions

Now that you have installed the unit, let's take a moment and get familiar with the buttons and the functions of C30.

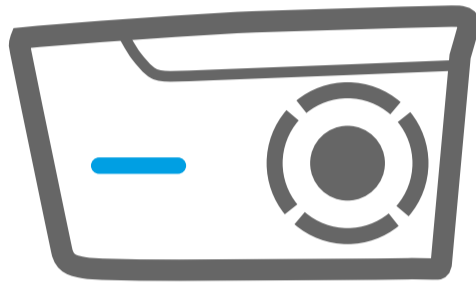

Buttons and types of clicks



UP



DOWN



O



+



-



Single Click



Double Click



Long Press



Here are some examples

Play/Pause Music



Single Click
O Button

Mute/Unmute mic





Double Click
UP Button

Turn ON/OFF



Long Press
O Button

Start Bluetooth Pairing



Single Click
+ & - Button

PREV



NEXT



Getting Started

03 - Powering ON/OFF

You are now ready to start using the device, so let's get started.

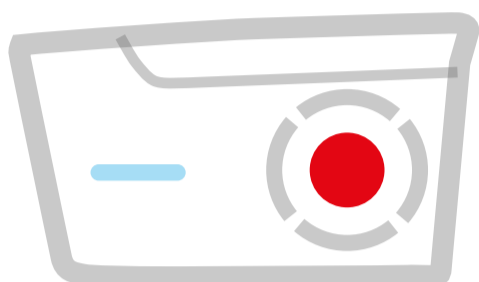

Long Press the **O Button** to turn ON/OFF. Device will play a welcome note followed by battery percentage. A headset test will check if it's connected. (LEDs will glow yellow if test fails.)

The LED on the device will light up to indicate power up and battery level. Refer to table below to understand the read out.



Battery > 95%

Blue 3secs - Green 3secs - Blue constant



70% < Battery < 95%

Blue 3sec - Green Pulses 3 times in 3secs - Blue constant



40% < Battery < 70%

Blue 3sec - Yellow Pulses 3 times in 3secs - Blue constant



10% < Battery < 40%

Blue 3sec - Red Pulses 3 times in 3secs - Blue constant



Battery < 10%

Blue 3sec - Red 3secs - Blue constant

PREV



NEXT



Getting Started

04 - Pairing device to phone

To Mobile phone (Basic mode)

For best experience, we recommend using the app, however C30 can also connect to the phone via Bluetooth Classic for basic functions (Phone calls, Music & Navigation)

To pair you need to set the device to Bluetooth pairing mode. To do this, **Single click + & - Buttons** together once.

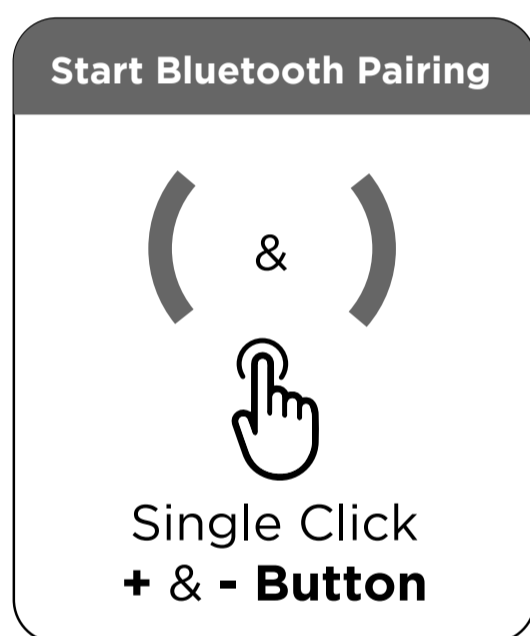
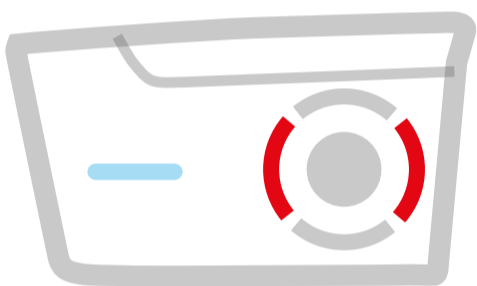

The device will start blinking blue to indicate it is now in advertising mode.



Complete pairing & allow contact access on your phone.

You need to do this only the first time. Device will autoconnect to the last connected phone.

PREV



NEXT



MENU



Getting
Started

05 - Connect App

For the full range of features of the C30 device to work you will need to install the app on your phone. Apart from the main controls, the app also features an interactive version of this user manual and links to how to videos.

You can also access the customer support links from the app if you need additional help or guidance.

Both Android and iOS devices are supported. Install the app and follow the steps inside the app to complete the process.



PREV



NEXT



Getting Started

06 - OTA firmware update

C30 is continuously updated with newer and better features. These improvements are easily updated Over-the-Air (OTA) via the app itself and you don't need any cables or additional docks or devices.

Check the app to see if you need an update. You will see an alert on the main dashboard if your device requires one.

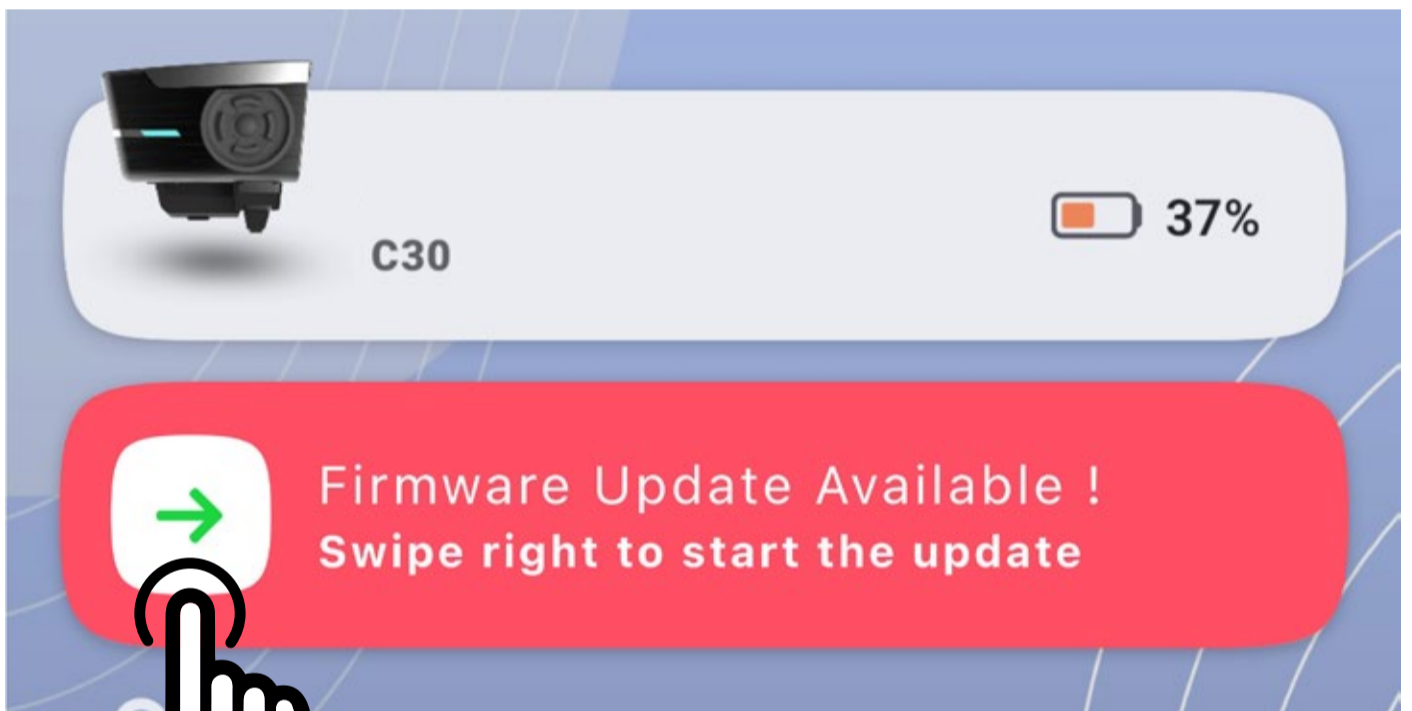

SWIPE

App Dashboard will prompt a firmware update alert.

Swipe right to initiate update.

Just tap and follow the steps, ensure your device is atleast 50% charged before you start the update and don't turn off the device during the process. The app will indicate the progress status.

PREV



NEXT



Getting Started

07 - Pairing to second phone

Once you are connected to your first phone, you have the option to connect your second phone too. This second connection will allow you to answer calls. To pair the second phone, use the app on the phone and tap on the “Connect Second Phone” button.

Tap on the settings icon on the top right of the app to find this menu.

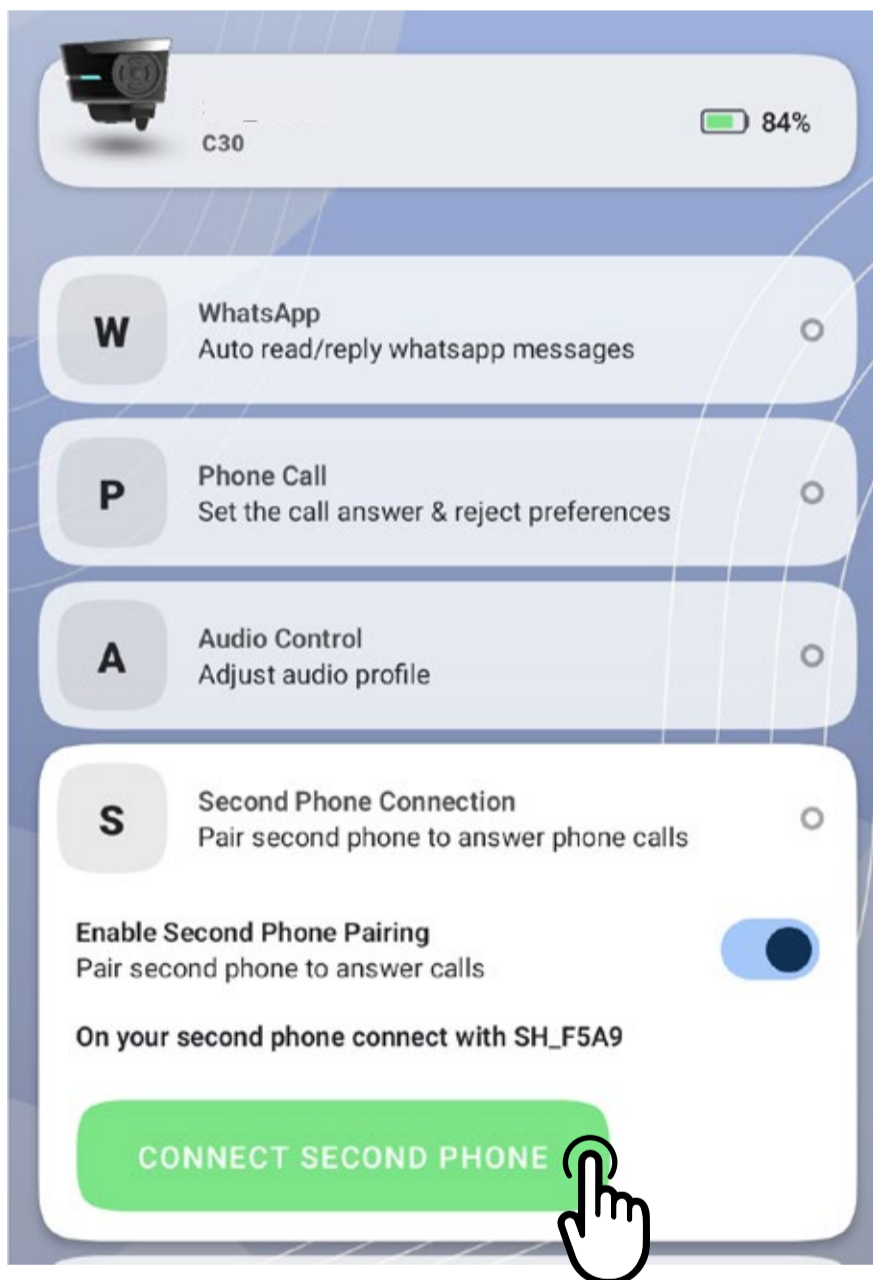

Once connected, phone calls received on the second phone can be answered via the C30 unit.

Note - You can either use the RIDELYNK intercom or connect your C30 unit to a second phone at any given time.

PREV



NEXT



MENU



Phone
Usage

Phone Usage

How to use your phone's features



01

Phone calls

02

Call volume controls

03

Auto-answer & settings

04

Music & audio

05

Music volume controls

06

Navigation

PREV



NEXT



MENU



Phone Usage

01 - Phone calls

You are now ready to start using the device. Let's start from the top.

Responding to incoming calls

To answer an incoming call, **single-click the O button**. You can terminate an active call with a **double-click of the O button**.

You can also reject incoming calls with a **double-click of the O button**.

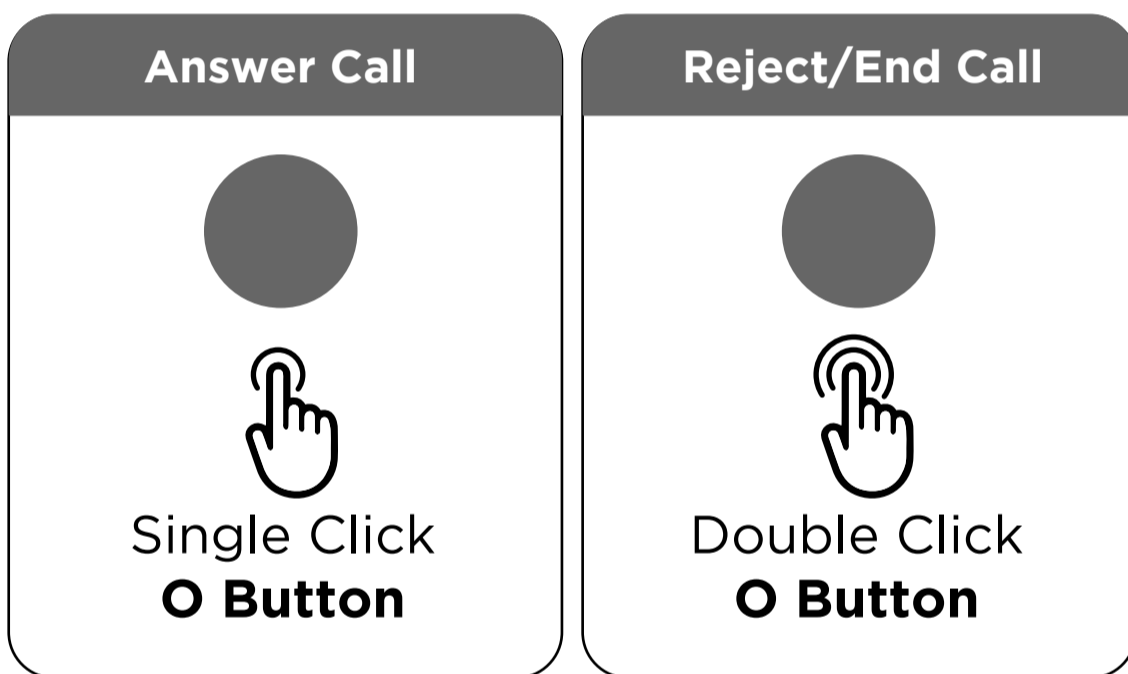

Making phone calls ^{*}(setup assistant on phone)

While riding, please use the voice assistant on your phone to initiate phone calls.

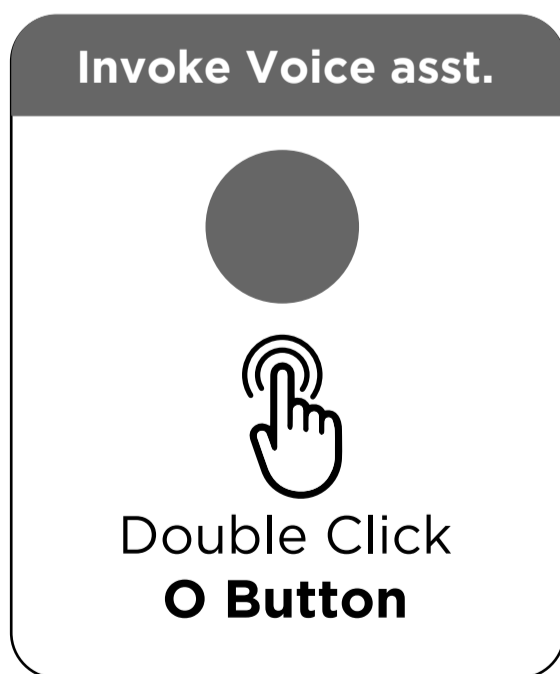

You can invoke the voice assistant with a **double-click of the O button**.

PREV



NEXT



MENU



Phone
Usage

02 - Call volume controls

During an active call you can increase or decrease the **device** volume by pressing the **+ or - buttons**.

Beeps are heard when volume is changed and also at max and min limit.

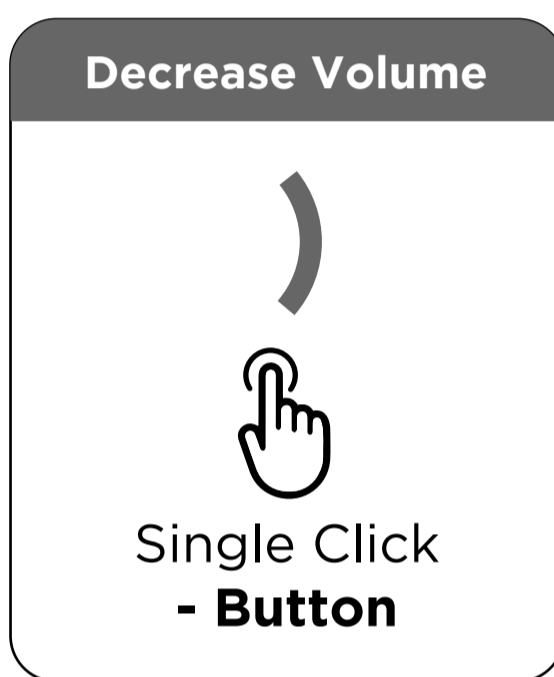
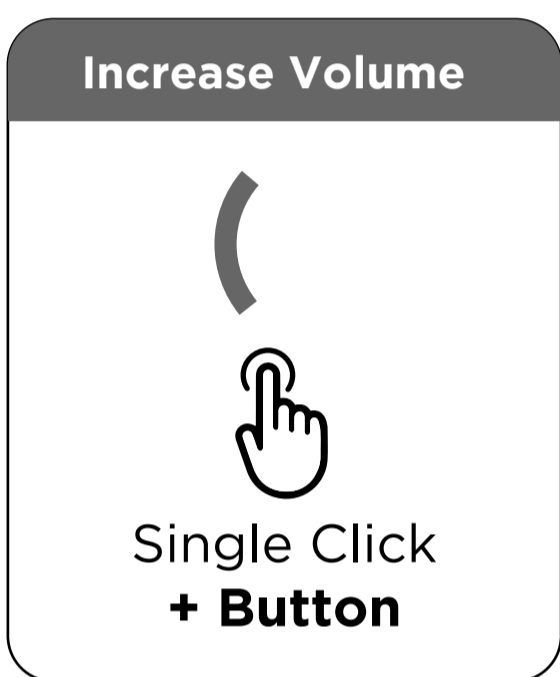

Use of Voice Asst for these controls

You can use the voice assistant (Siri or Google Assistant) to control volume. Note this is the **phone** volume.

You can invoke the voice-assistant with a **double click** on the **O button**.

Try saying **“Increase volume to 80%”**

PREV



NEXT



MENU



Phone Usage

03 - Auto-answer & settings

You can configure your phone-call preferences through the app. An array of auto-accept/auto-reject options are available - these can be set as desired.

Tap on the settings icon on the top right of the app to find this menu.

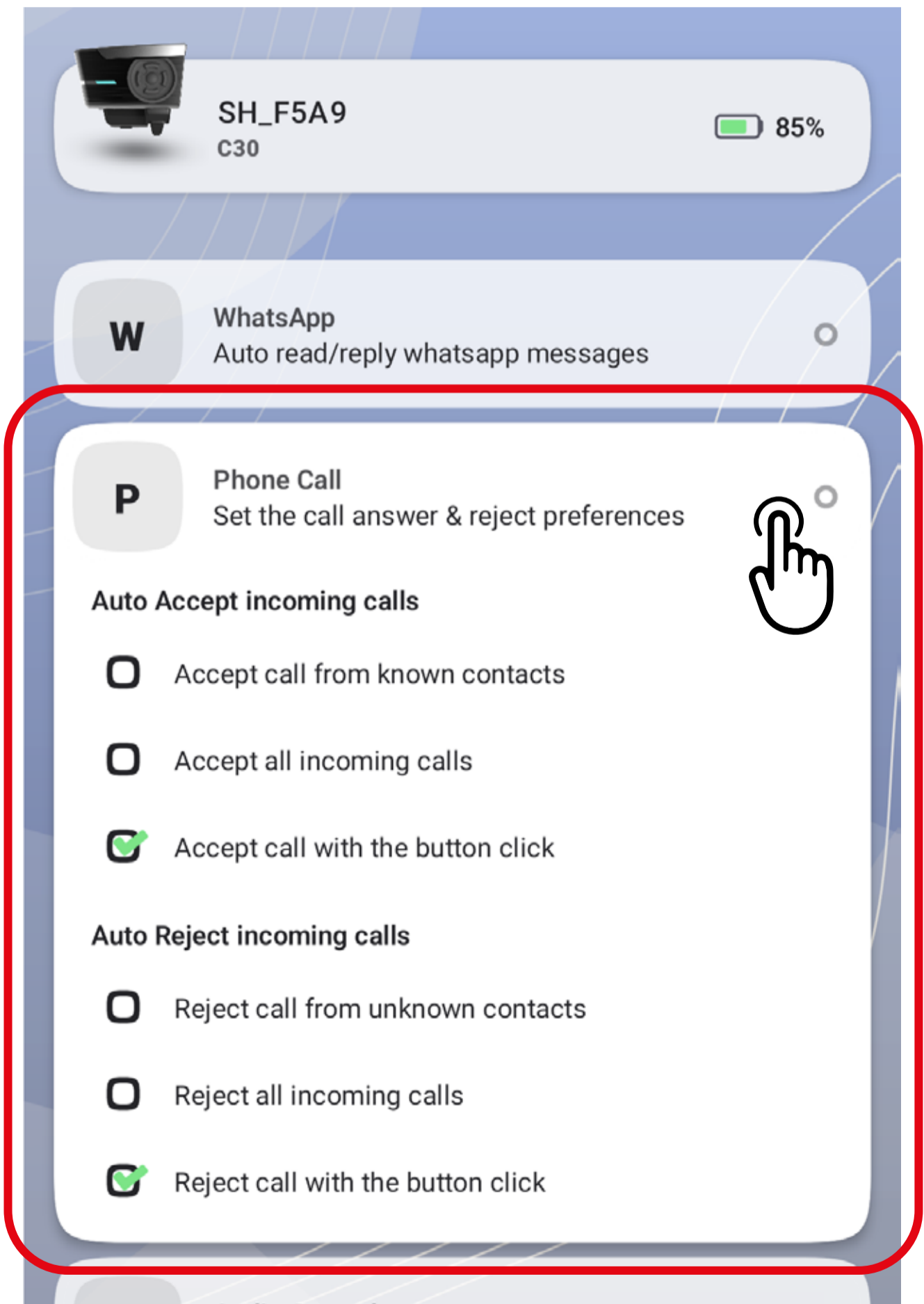

PREV



NEXT



Phone
Usage

04 - Music & audio

Choose a music/audiobook/podcast app of your choice and launch it on the phone.

You can control any of your favourite music or audio apps using the device. The device recognizes the current player/app that your phone is using and provides controls for the same via the device & app.

Note: The music app should support AVRCP (Audio Video Remote Control Profile)

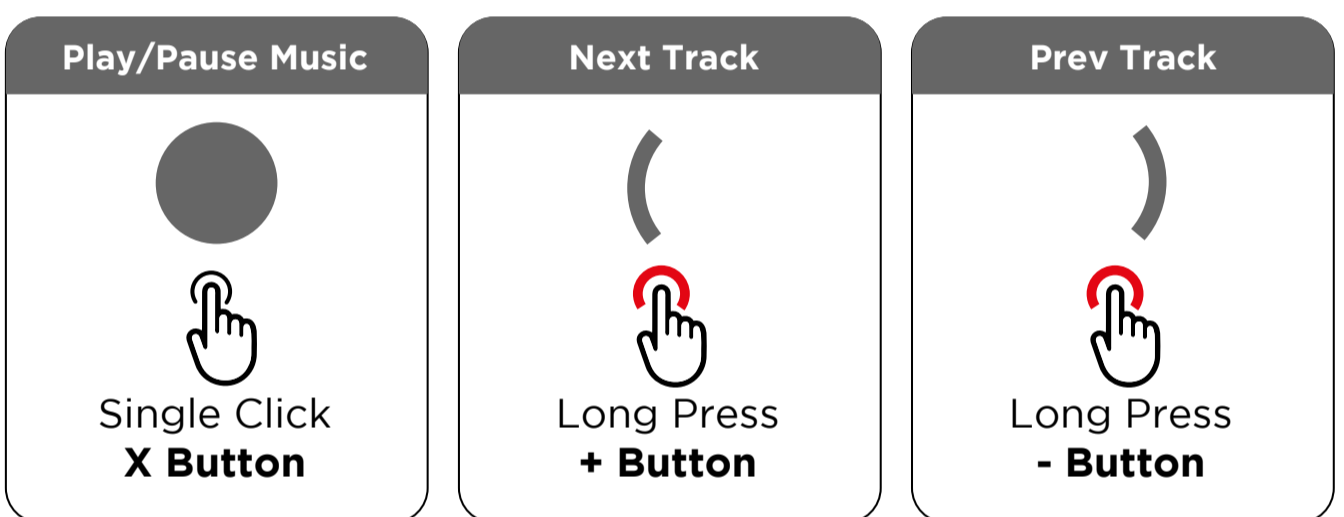

Play/Pause, Next & Prev controls

play/pause music - Single-click the O button

next track - Long press the + button

prev track - Long press the - button*

*Note - If you are listening to a track, the first Long press action on the - button will take you to the beginning of the current track. Long press the - button again to take you to the previous track.

PREV



NEXT



05 - Music volume controls

The +/(-) buttons can be used to increase /(decrease) the **device** volume. There are 15 possible volume levels between the minimum and maximum. A single-click action on the +/(-) button will increase/(decrease) the **device** volume by one level.

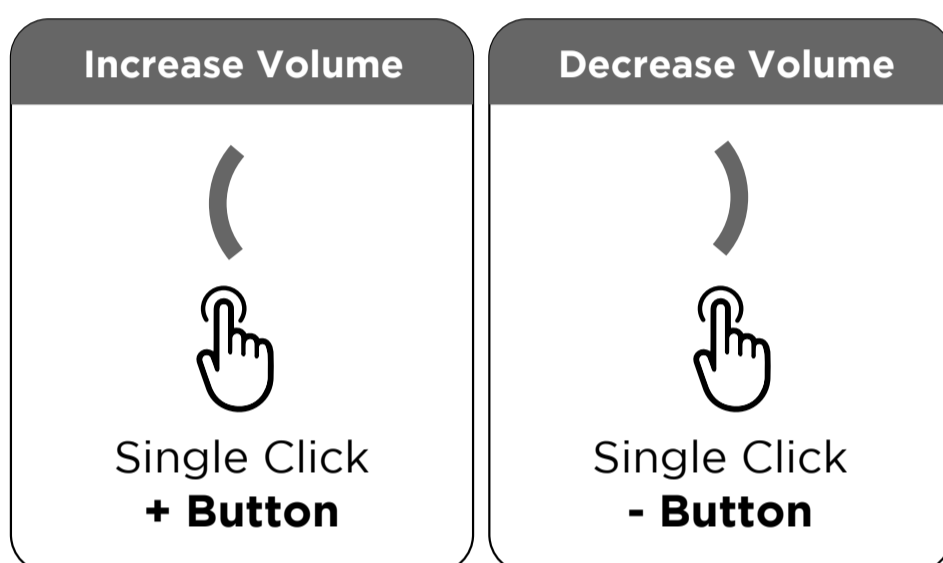

Use of Voice Asst. for these controls

You can change the music tracks or the phone's volume through the voice assistant.

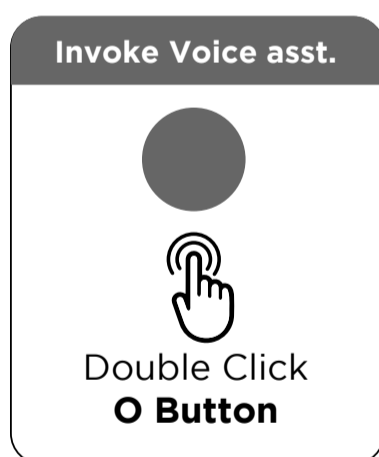

A **double-click** on the **O button** invokes the voice assistant. You can then issue the desired commands. Volume change here will affect the **phone** volume, not the device.

Examples:

"Go to next track"

"Increase volume to 80%"



MENU



Phone
Usage

06 - Navigation

Navigation instructions over voice

Navigation instructions from your mapping/navigation app will be announced over the headset.

Use of Voice Asst for these controls

You can ask the voice assistant for navigation assistance. The voice assistant is invoked through a **double-click action** on the **O button**.

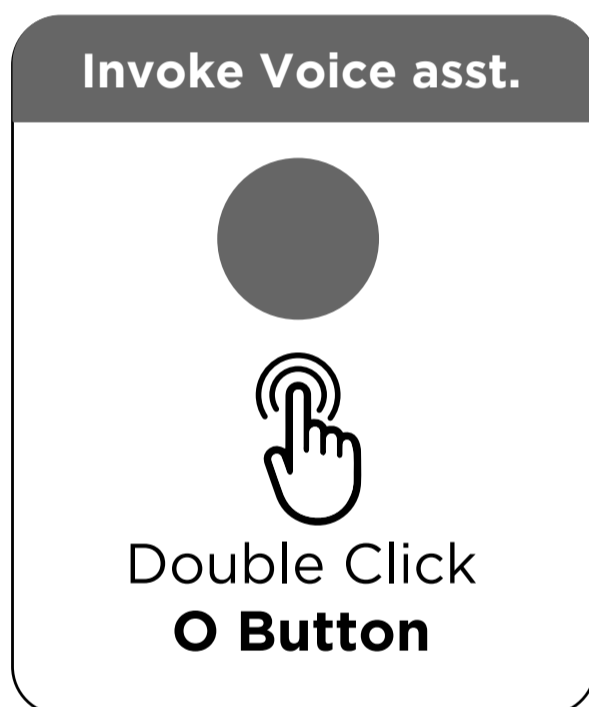

Example:

"Take me home"

"Take me to the closest petrol station"

PREV



NEXT



MENU



Intercom
Usage

Intercom Usage

RIDEGRID™ and RIDELYNK™



RIDE GRIDTM



RIDE LYNKTM

PREV



NEXT



MENU



Intercom
Usage



RIDEGRID™ - Mesh Intercom

RIDEGRID™ is an intercom mesh technology that uses its advanced algorithm to connect multiple C30 devices (upto 20 for optimal performance) together to form a flexible intercom network that allows riders to freely go out and come back into the large group call.

This self healing and clustering quality of RIDEGRID™ makes it extremely user-friendly and easy to use in the real world situations that you ride in.

RIDEGRID™ range between 2 riders is 1.1 Km.
(2 Users maintaining LOS on an open highway)

PREV



NEXT



MENU



Intercom
Usage

RIDEGRID™ Feature overview

Out of the box, the devices are set to RIDEGRID™ public mode, which will allow them to join automatically.

It is also possible to create private groups using the app. There are multiple methods to invite other users or join private groups. (Invite friends & scan QR code)

The maximum number of groups that a user can be part of is 5.

Any member of the riding group can invite new members in.

A member can freely choose to leave the group.

Clustering: While on a RIDEGRID™ call, users who are within range of each other but collectively out of range from other riders in the same group will be able to talk to each other.

Self-healing: Riders automatically rejoin the call as they come back into range.

PREV



NEXT



MENU



Intercom
Usage

Public Group

To start a call in public mode, **Long press UP button** on the devices.



They will join the mesh and the call will start automatically.

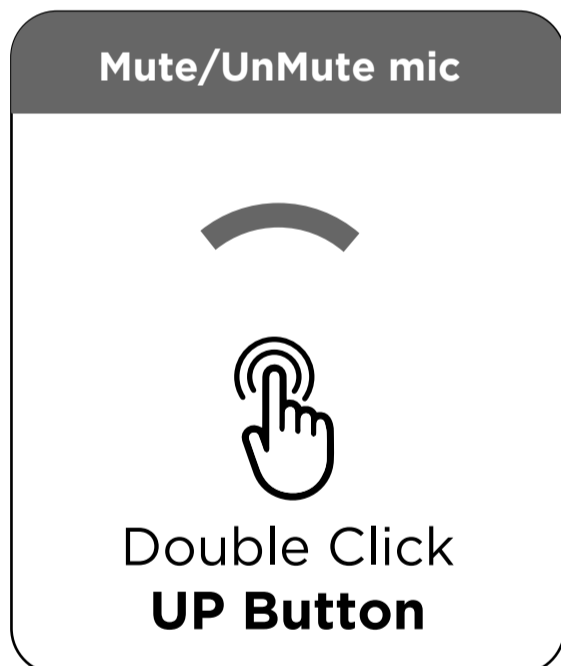

Once call is active, you can exit / re-enter the call with a **single click UP button**.

You can also Mute/Unmute your mic by **double clicking UP button**.

PREV



NEXT



Private Group creation via app

It's mandatory that the app is used for the creation and management of RIDEGRID™ private groups.

To create and manage groups tap the RIDEGRID™ module. The first time you open this module, it will automatically take you through the setup and group creation steps.

Tap on (+ New group), you will then be taken through the steps to create the private group. Once setup, you will then have an option to invite others via a QR code. Ask your buddies to scan the code via their app with the QR scanner option inside the RIDEGRID™ screen.

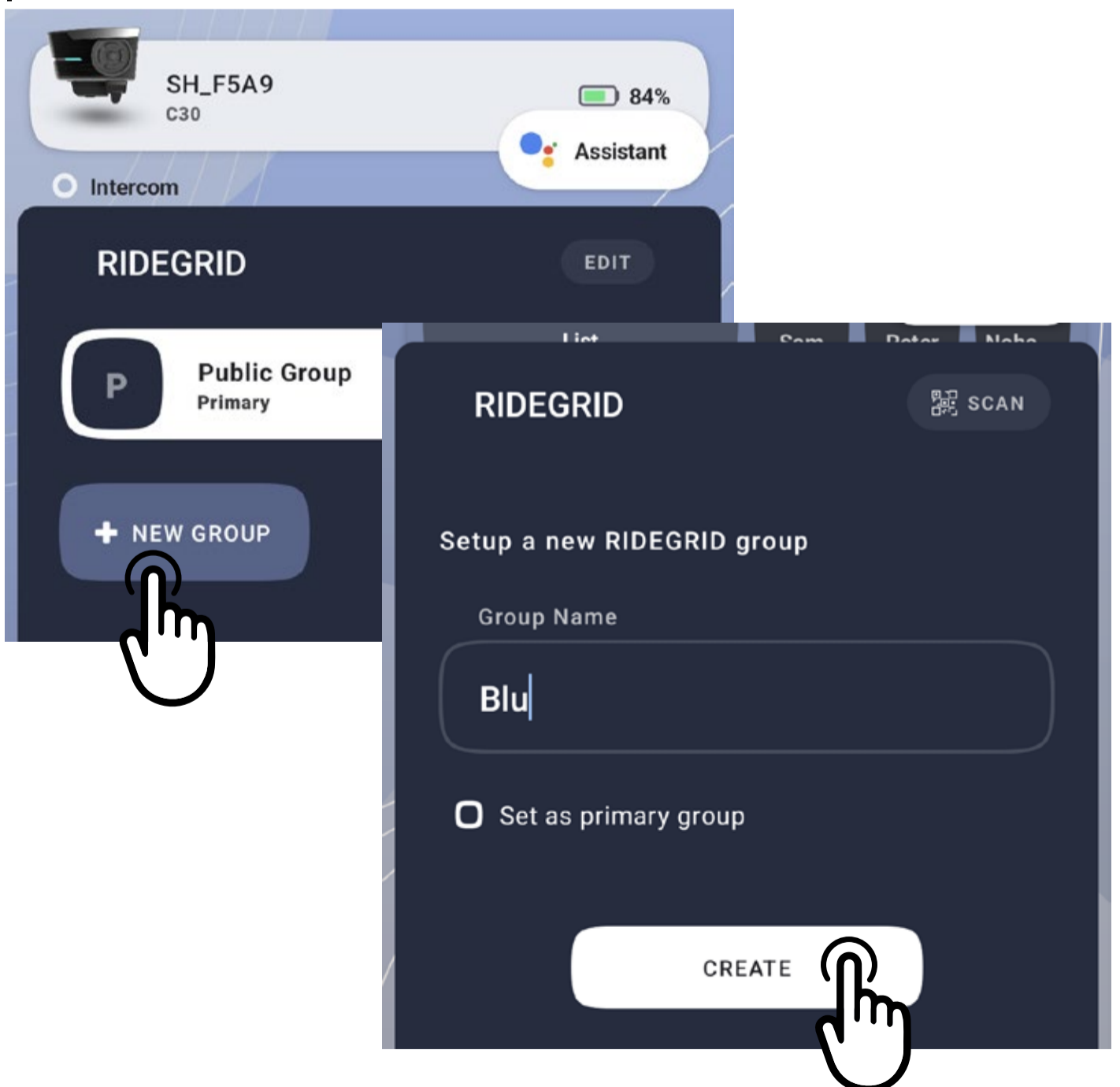



MENU



Intercom
Usage

Merging active phone call with on going RIDEGRID™ call

While on a RIDEGRID™ call, if you receive an incoming phone call and answer it, you get disconnected from the RIDEGRID™ call.

You can keep the phone call private and you will be automatically placed back in the RIDEGRID™ call once you terminate the phone call

If you wish to merge the RIDEGRID™ call with the phone call, **double click Up button.**

To unmerge the call, **double click Up button** again.

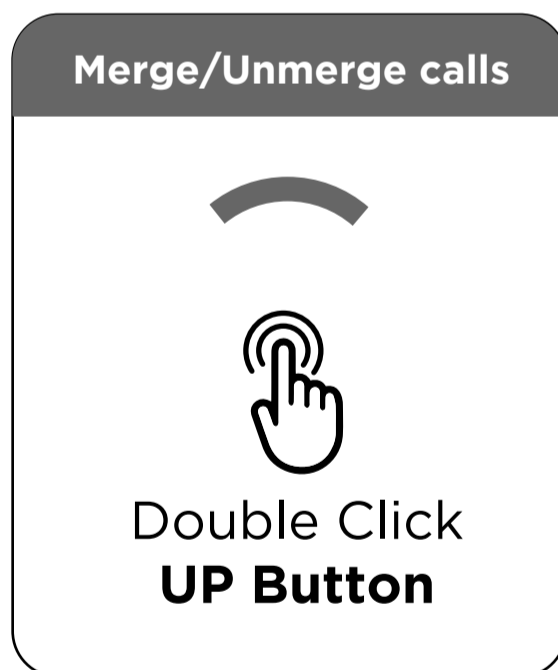

PREV



NEXT



MENU



Intercom
Usage



RIDELYNK™ - 2-way Classic intercom

What is RIDELYNK™ (2-way intercom)?

RIDELYNK™ is an intercom between two C30 devices.

C30 device is also capable of connecting to other bluetooth headsets via the **Universal Intercom** feature that is a part of this RIDELYNK™ intercom protocol.

Note: This is not the Mesh intercom feature to connect multiple riders.

RIDELYNK™ range is recommended between Rider and Pillion only. Maximum range in ideal conditions is 50m

PREV



NEXT



Intercom
Usage

Pairing via app

On the App's dashboard, tap on RIDELYNK™. The device will start to search for others in range. Your riding buddy/pillion must be in range with his/her device in RIDELYNK™ pairing mode via the app too.

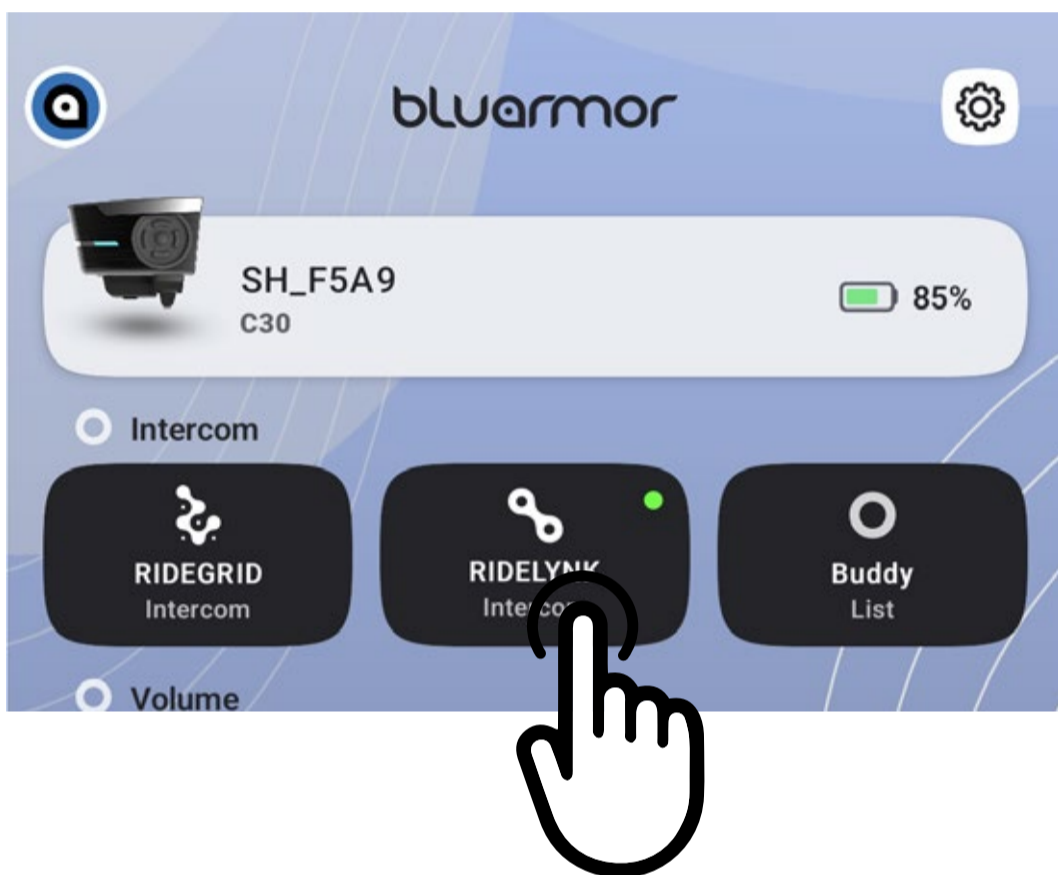

The app will display all the users who are in range and are available for pairing. You can select the user you want to connect to and initiate the pairing process. Once paired the call will start automatically.

You can repeat this process and add more riding buddies to your device. They will show up as a list on the app. You can now choose 5 of them out of this list for the speed-dial feature. Adding them to speed-dial makes it easier for you to connect to them while riding.

PREV



NEXT



MENU



Intercom
Usage

Pairing via device

To pair with a buddy using the device, you can **long press the Down button** to start pairing. The same needs to be done by the buddy who is seeking to connect with you. Keep the devices close to each other (around a feet apart). Allow a few seconds and the devices will find each other and pair automatically.

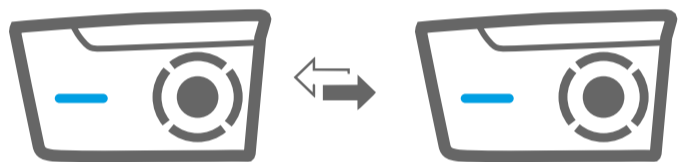

Once paired, the **RIDELYNK™ call will start automatically.**

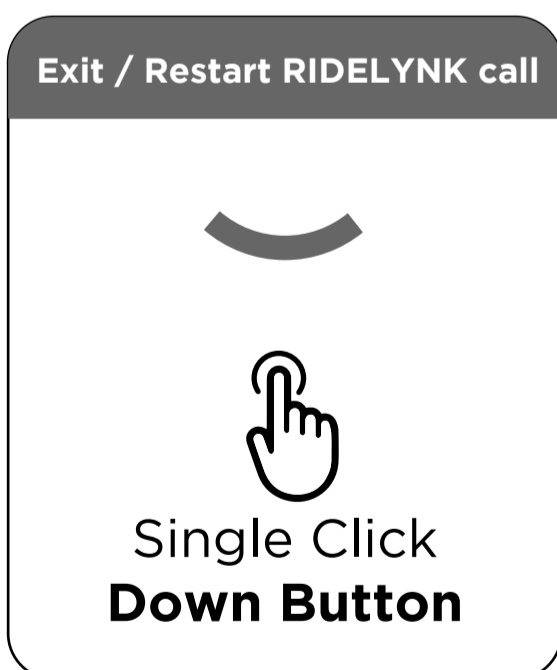

Once RIDELYNK™ call is ON you can Exit and Restart the call with a **single click** of the **Down button**. You can also increase / decrease vol with + and (-) buttons.

PREV



NEXT



MENU



Intercom
Usage

Universal Intercom

Universal intercom is the ability to connect with other non C30 devices that support Universal Intercom including generic bluetooth headsets. To do this, you use the same steps as before via app or device.



Open RIDELYNK™ on the app or **long press the down button** to start advertising and ask your buddy to also initiate the pairing process on his/her device by initiating advertising mode. The devices should find and pair up automatically in 10 to 20 seconds.

Note: Universal intercom cannot be set up for Speed-dial.

PREV



NEXT



MENU



Intercom
Usage

Add other brand model or any other Universal Intercom device as guest to RIDEGRID™ call

It is possible to add guests into a RIDEGRID™ call who don't have a C30 device. Though limited, it's possible to connect a pillion or a ride buddy on a motorcycle to your C30 device and merge them into the larger RIDEGRID™ call.

First ensure that two or more C30 devices are connected via RIDEGRID™.

Next, turn the Bluetooth Intercom device to Bluetooth pairing mode. On your C30 device, turn on RIDELYNK™ and start discovery on the app.

Click on the Bluetooth Intercom device on the list. The RIDELYNK™ call will automatically be established.

The RIDEGRID™ call will be placed on hold for the C30 device initiating the RIDELYNK™ call.

Finally, merge the RIDEGRID™ call with the RIDELYNK™ call by double clicking the top button

Note: RIDELYNK™ (Universal Intercom) usable-range will be lower than it is between two C30 devices on RIDEGRID™. Recommended for Rider-Pillion use cases, max range in ideal conditions is 50m.

PREV



NEXT



Intercom
Usage

Speed-dial Intercom feature

Speed-dial is a feature that allows you to initiate calls with buddies who are saved on the list. To do this you need to first select buddies in your list and add them as speed-dial contacts. You can do this on the app and can have up to 5 speed-dial buddies.

Note : Speed dial **will not work while** you are on a RIDELYNK™ call. You will need to end the active RIDELYNK™ call and then turn off RIDELYNK™ too.

To initiate speed-dial using the device, **single click Down button.** This will initiate the speed dial feature and start with last called rider. To choose, **single click O** or select the next rider with **single click +** to go to the next slot, you can **press +** again to toggle down to the next rider.

Note : You can toggle between your saved speed dial list from 1 to 5 and choose to call the desired rider by **pressing O once.**

You can also use the app if you have mounted it on your motorcycle by tapping on the the speed-dial icons.

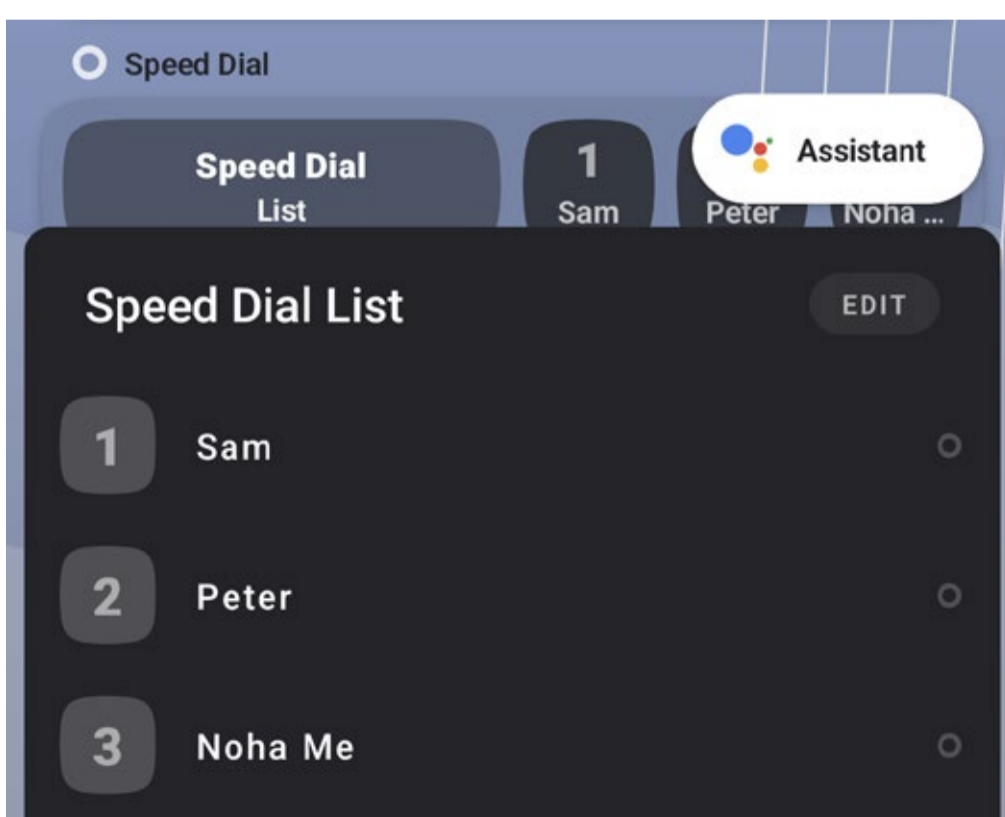

PREV



NEXT



MENU



Audio/Voice
Experience

Audio/Voice Experience

Controls for sound



01

Audio controls

02

Volume controls

03

EQ controls for music

04

Dynamic volume control

05

Active noise control

06

AudioWeave™

PREV



NEXT



MENU



Audio/Voice
Experience

01 - Audio controls

Play/Pause, Next & Prev controls

play/pause music - Single-click the O button

next track - Long press the + button

prev track - Long press the - button*

*Note: If you are listening to a track, the first long press action on the (-) button will take you to the beginning of the current track. Long press the (-) button again to take you to the previous track.

Play/Pause Music

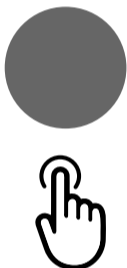

Single Click
X Button

Next Track



Long Press
+ Button

Prev Track



Long Press
- Button

PREV



NEXT



02 - Volume controls

Volume control

Volume control is possible either through the device or the app. The + and - buttons can be pressed once increase or decrease the volume while listening to music or attending calls.

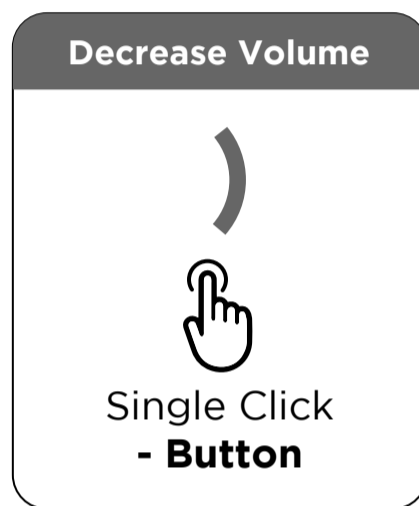
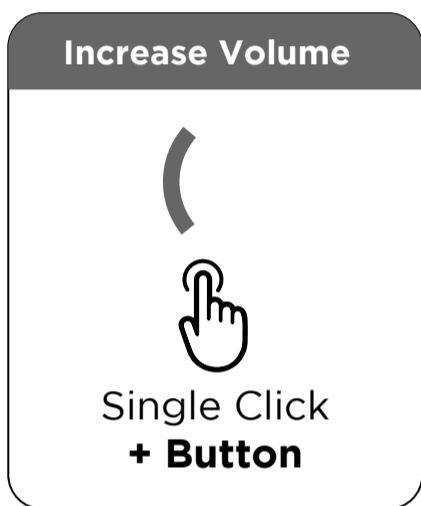

On the app, there is a dedicated volume slider that allows you to set the desired volume.

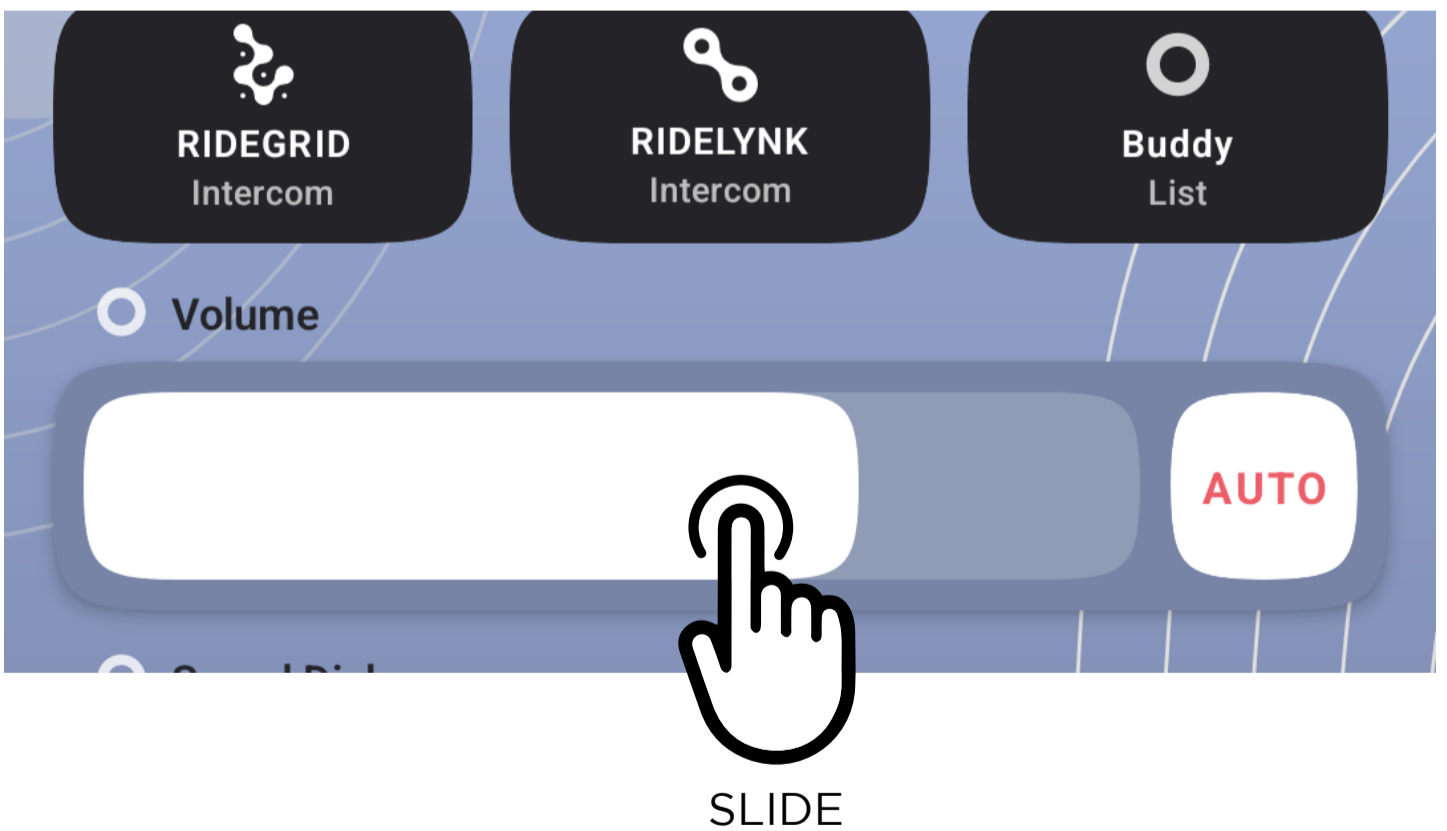



MENU



Audio/Voice Experience

03 - EQ controls for music

In the menu you can access the audio presets that allow you to control Volume boost and Equaliser preferences.

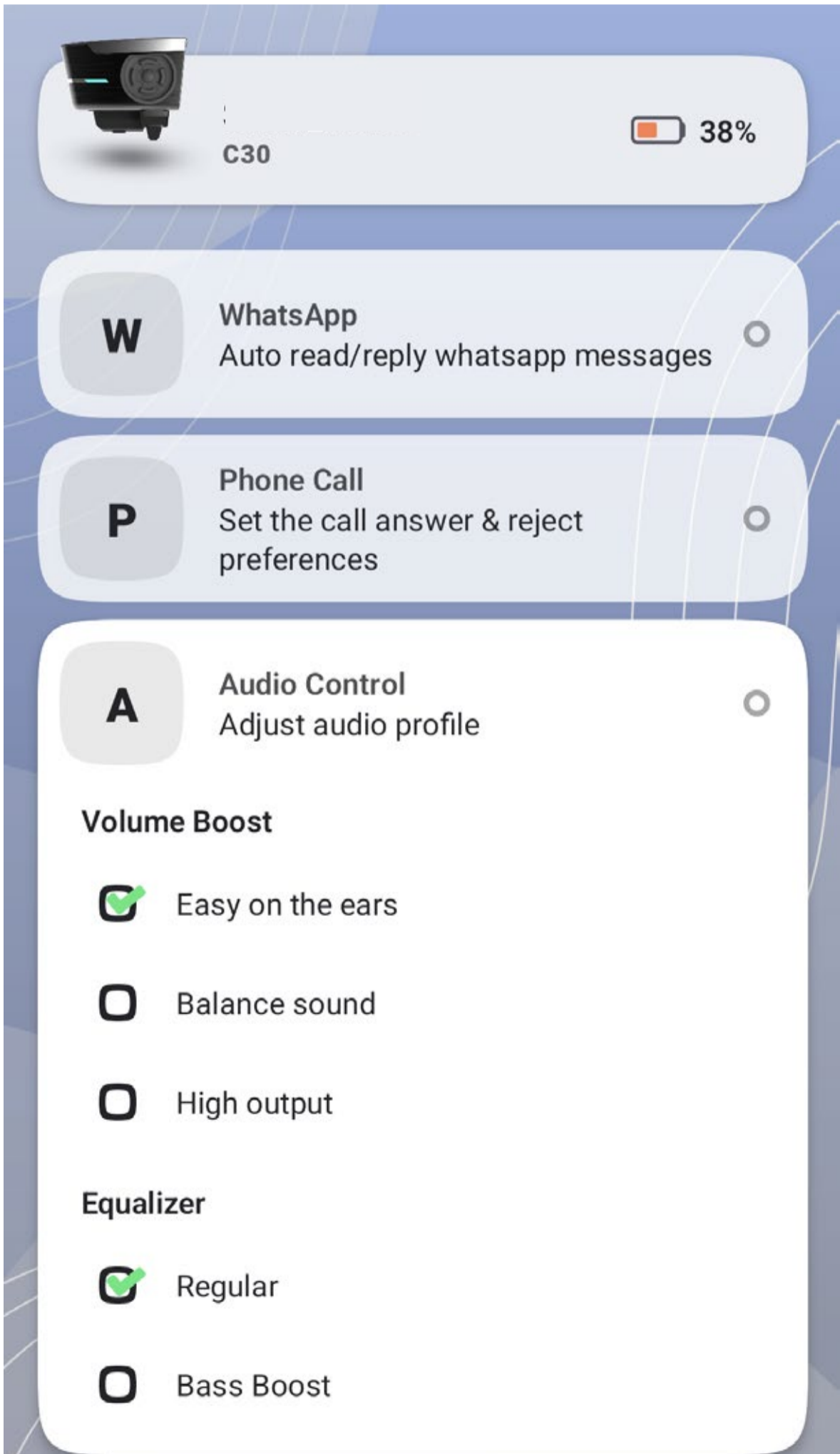

PREV



NEXT



04 - Dynamic volume control

This additional toggle, also seen on the volume slider module, allows you to set up volume level controls that increase or decrease based on your speed. This feature is useful if your helmet allows a larger amount of wind noise through at higher speeds.

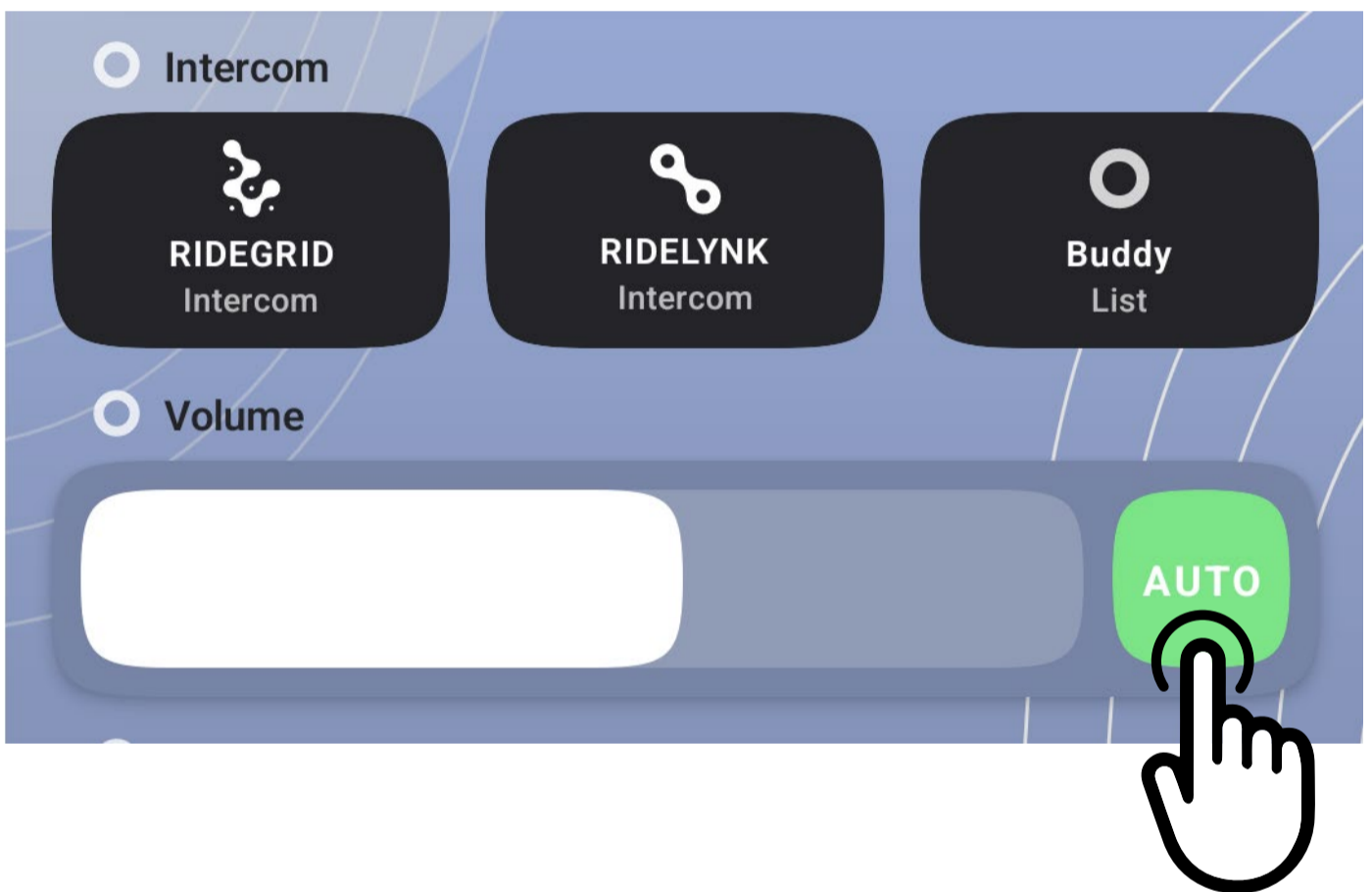



MENU



Audio/Voice
Experience

05 - Active noise control

Quality of voice conversations is improved through active noise control. The algorithm suppresses wind noise in the microphone path allowing other riders to hear you clearly.

This filter is active through out, you don't have to change any settings.

PREV



NEXT



06 - AUDIOWEAVE™

Audio Weaving explained

Through AudioWeave™ technology, you can

1. Continue listening to music while on a RIDEGRID™ intercom call
2. Use the voice assistant while on a RIDEGRID™ intercom call
3. Mix/merge audio from a RIDEGRID™ call with audio from a RIDELYNK™ call

When the user invokes the assistant, the microphone will automatically be muted for RIDEGRID™.

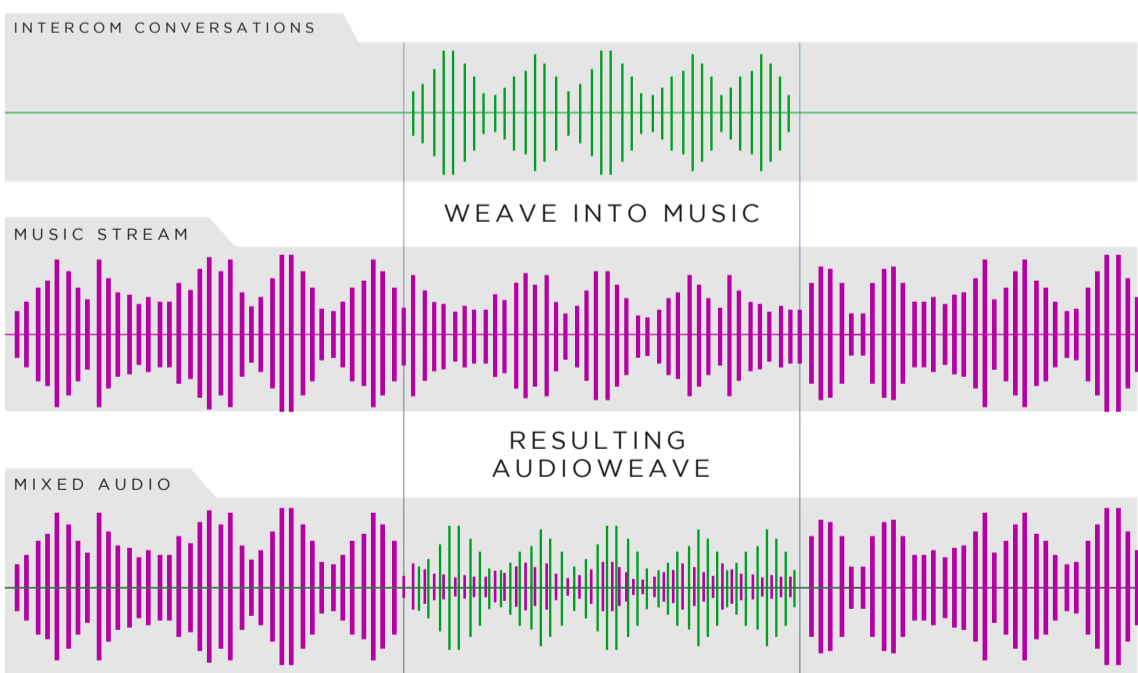

Music volume auto reduces during Intercom conversations





MENU



Audio/Voice
Experience

06 - AUDIOWEAVE™

Audio Weaving controls

An audio-overlay flag that is setup on the app will determine how the user regulates the volume between music and group intercom. If the audio-overlay flag is OFF, then the music volume is not dependent on the activity on the RIDEGRID™ group intercom. The music will stream at a volume determined by both the phone volume and the device volume while the RIDEGRID™ intercom will operate at the device volume.

If the audio-overlay flag is ON, then the music volume is dependent on the activity on the RIDEGRID™ group intercom. When there is no activity, the music will stream at a volume determined by both the phone volume and the device volume. When there is activity on the RIDEGRID™ group intercom, the music will play at 20% of the volume setting to allow the user to clearly hear the RIDEGRID™ conversations.

PREV



NEXT



MENU



Settings &
FAQs

Settings & FAQs

Technical help



PREV



NEXT



MENU



Settings & FAQs

Factory Reset

To reset the device back to factory settings Long-Press the + & - Buttons for 10 secs.

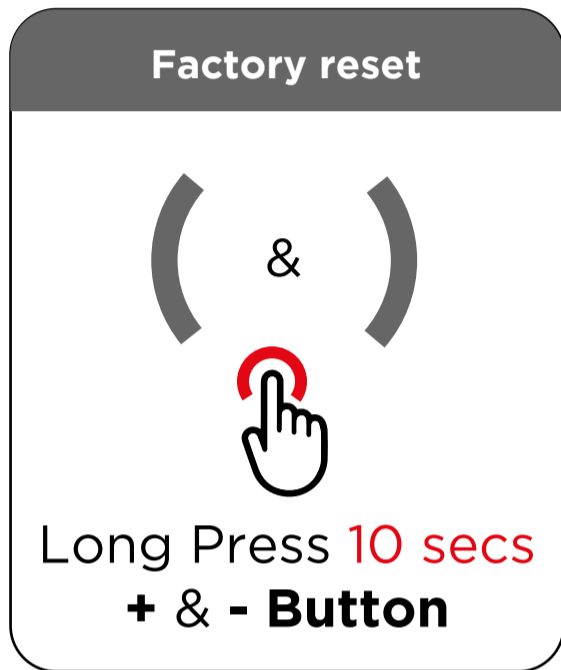
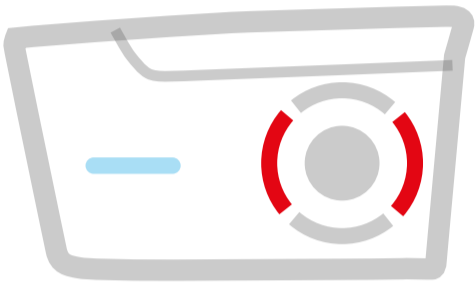

Reboot

To reboot the device press all three buttons together.

