

WAVEFILE X CPM

6000X

Setup and Operating Manual



OrthoAgility™

Table of Contents

CPM Device Information	2
Indications	2
Application	2
Clinical Advantages	2
Patient Setup Instructions	3-8
Step 1: Attaching the Splint	3
Step 2: Attaching Finger Clips and Finger Actuators	3
Step 3: Attaching and Positioning the CPM Actuator	4
Replacing/Changing Finger Actuators	4
Right to Left Hand Setup	4
Silipos Digital Cap Directions for Use	5
Thumb Application	6
MP Block (Intrinsic Minus Position)	7
Glove Directions for Use.....	8
Special Attention Warning	8
Programming Instructions	9-11
Before Programming.	9
Programming Range of Motion.	10
Programming Speed.	10
Programming Pause.	10
Warm Up Feature.	10
Hidden Features.	11
Symbols, Specifications and Ordering Information	12
Cautions and Warnings	13
Maintenance	14
Warranty	15

CPM Device Information

Indications

Immediate post-operative management after the following where indicated:

- Capsulotomy, arthrolysis and tenolysis for post-traumatic stiffness of MP and PIP joints;
- Open reduction and rigid internal fixation of intra-articular, diaphyseal and metaphyseal fracture of the phalanges and metacarpals;
- Flexor and extensor tendon tenolysis;
- Flexor and extensor tendon synovectomies, following arthrotomy and drainage of acute septic arthritis;
- Prosthetic replacement of MP and PIP joints;
- Stable fractures;
- Crush injuries of hand without fractures or dislocations;
- Hand or digit reattachment;
- Dupuytren's Contracture Release;
- Burn injuries; and,
- Reflex Sympathy Dystrophy (RSD).

Application

Continuous Passive Motion (CPM) is best applied immediately post-operative and continued, uninterrupted, for an average of four to six weeks or as prescribed by the Physician.

Clinical Advantages

Maintenance of a good range of motion.

Prevention of intra-articular adhesions.

Prevention of extra-articular contractures.

Reduction of post-operative pain.

Prevention of negative effects of immobilization.

Note:

Allow device to reach room temperature for a minimum of one hour prior to use.

Patient Setup Instructions

STEP 1: Attaching the Splint

Place the splint on the forearm with the distal end of the splint extending to the middle of the MP joints (figure 1). Next, form the sides of the Splint to contour to the forearm and hand. Tighten the splint onto the forearm and hand with the Velcro straps (figure 2).

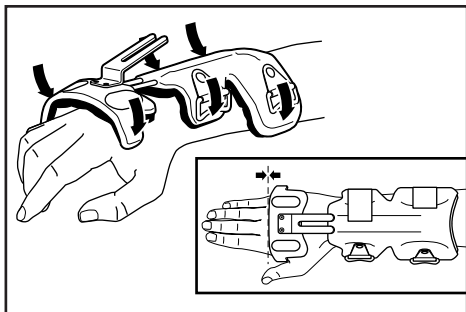

Figure 1

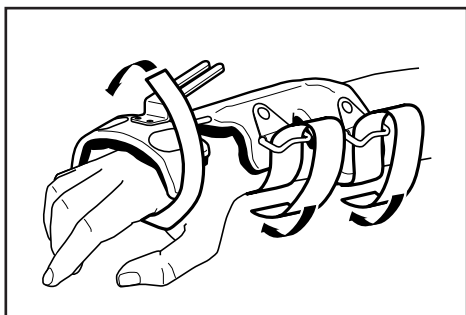

Figure 2

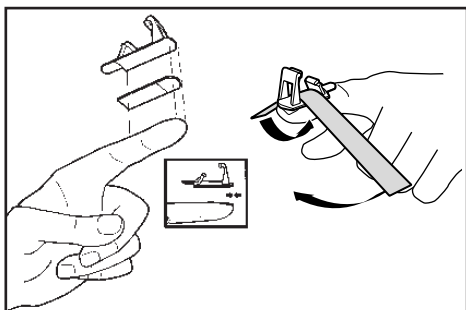

Figure 3

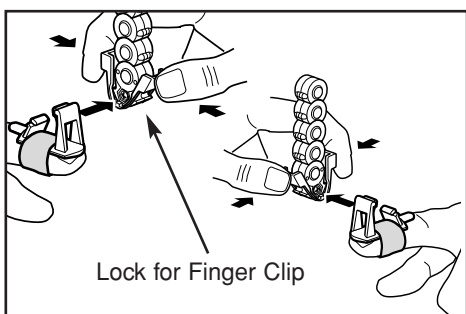

Figure 4

STEP 2: Attaching Finger Clips and Finger Actuators

First, apply the fully-adhesive side of the VHB Pad to the underside of the Finger Clip. Next, peel the label off the adhesive portion of VHB Pad and place the adhesive portion onto the finger nail while positioning the Finger Clip to align with the end of the finger (figure 3). Gently apply pressure to secure the adhesive bond between the nail and Finger Clip.

Peel and wrap a Finger Strip around the finger and Finger Clip to complete the attachment (figure 3).

The Finger Actuators are designed to easily clip in and out of the Finger Clips. To attach the Finger Actuators, roll the end of the Finger Actuator (Lock for Finger Clip) into the Finger Clip until you hear it engage (figure 4). Ensure Lock for Finger Clips are secure.

To detach the Finger Actuator, pinch together the lock for finger clip and laterally slide the lock for finger clip out of the Finger Clip (figure 4).

Important: *Attaching the Finger Actuators to the Finger Clips is best done after the CPM Actuator is attached to the splint and positioned correctly. (Please see the instructions "STEP 3: Attaching and Positioning the CPM Actuator.")*

Patient Setup Instructions (cont'd)

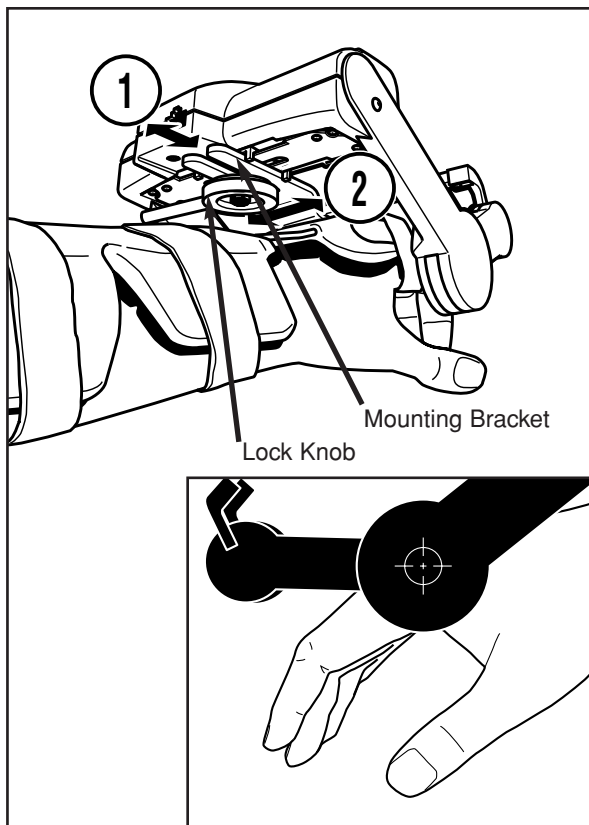

STEP 3: Attaching and Positioning the CPM Actuator

Slide the CPM Actuator onto the Splint's Mounting Bracket. (In order to slide the Actuator onto the Mounting Bracket it may be necessary to loosen the Lock Knob by turning it several times.)

Correctly position the Actuator so that the center of the large round hinge aligns with the center of the MP joints. Do this by loosening the Locking Knob and adjusting the CPM Actuator distally or proximally along the Mounting Bracket.

Note: To accommodate various patient sizes, the CPM Actuator adjusts proximally and distally (1), and laterally and medially (2).

Replacing/Changing Finger Actuators

The WaveFlex comes equipped with three medium Finger Actuators (black) and one small Finger Actuator (blue). Additional Finger Actuators in small, medium or large size may be ordered separately. See the Ordering Information chart for details.

To replace Finger Actuators, detach the black bar containing the Finger Actuators by removing both fastening screws with a Phillips screwdriver. With the bar detached, slide the Finger Actuator(s) off the bar and replace or rearrange them for left or right hand set up.

Right to Left Hand Setup

When changing from right to left hand, or vice versa, remove the Finger Actuators (see above instructions) and rearrange them so that the short Finger Actuator (blue) is always in position to attachment to the smallest finger.

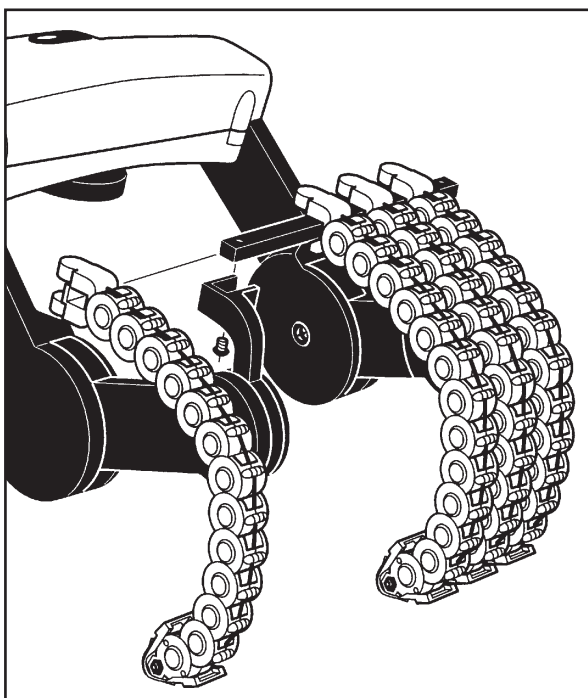

Patient Setup Instructions (cont'd)

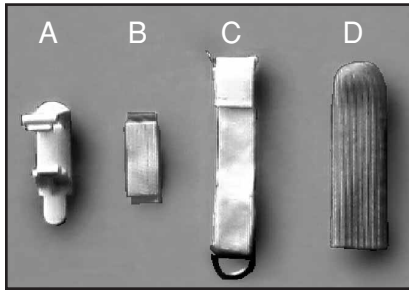

Figure 1



Figure 2



Figure 3



Figure 4



Figure 5

Silipos Digital Cap

A soft, comfortable and stretchable fabric fully coated with polymer gel which slowly releases a medical grade mineral oil (USP) to soften and moisturize the skin. Product is dermatologist tested, washable and reusable.

Indications:

Helps relieve pressure and friction on the affected digit. Also helps to reduce scar tissue.

For hammertoes, over/under lapping digits, keratotic lesions, or partially amputated digits. Also may be used for skin or nail problems due to dryness.

Parts needed (figure 1):

- A. WaveFlex clip
- B. Adhesive-backed Velcro hook
- C. Accessory D-Ring strap
- D. Silipos Digital Cap

Directions for Use:

1. Secure the Silipos Cap on the affected finger(s) by rolling the cap back and inserting tip of finger. Roll cap back and insert tip of finger (figure 2)
2. Roll cap onto finger and make any adjustments (figure 3). Reverse procedure to remove.
3. Preparing clip for use with Silipos Digital Cap. Remove adhesive backing from Velcro hook rectangle strip (figure 4). Apply Velcro strip to underside of WaveFlex finger clip.
4. Apply finger clip with Velcro hook to finger. Use D-ring accessory strap to secure finger clip onto Silipos Digital Cap (figure 5).

Note: Remove product at least 3 to 4 hours daily to allow skin to breathe.

Recommended Care:

We recommend that you hand wash product. Air dry and lightly dust product with talcum powder after drying.

WARNING:

Do not place product on an open wound. If irritation, discomfort or poor circulation occurs, discontinue use and notify your physician immediately.
KEEP OUT OF REACH OF CHILDREN.

Patient Setup Instructions (cont'd)

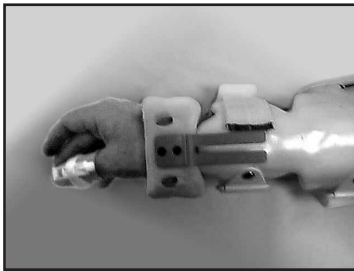

Figure 1

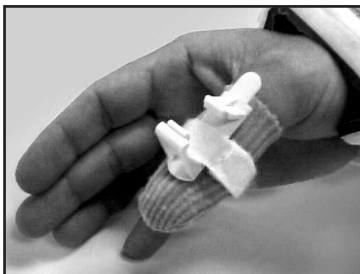

Figure 2



Figure 3



Figure 4

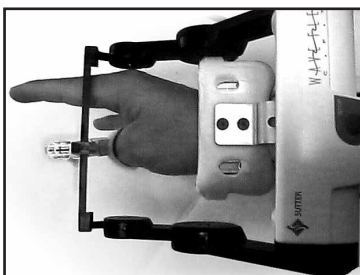

Figure 5

Thumb Application

1. Apply WaveFlex splint by rotating it from the dorsal forearm to the radial side as shown (figure 1).
2. Apply the WaveFlex finger clip to the thumb. Important: the center of the clip should straddle the DIP of the thumb as shown. This clip position allows for more opposition motion to occur (figure 2).
3. a) Apply the WaveFlex motor to the splint aligning the device with the CMC joint. The blue actuator provides good motion to the average sized hand. Other sizes of actuators should be considered depending on the size of the hand (figure 3).
b) The patient may have the tendency to move their wrist into ulnar deviation as the thumb flexes. To avoid this, the patient should place their hand on a flat surface such as a table, couch arm, or other comfortable surface.
4. This is what the device looks like in full opposition/flexion. It is important that the actuator bar does not hit the index finger when it reaches this position as this could cause irritation to the patients skin (figure 4).
5. This view gives you a look at alignment of the motor with the CMC joint as well as the unit in full flexion/opposition with the actuator bar near, but not touching, the index finger (figure 5).

Patient Setup Instructions (cont'd)

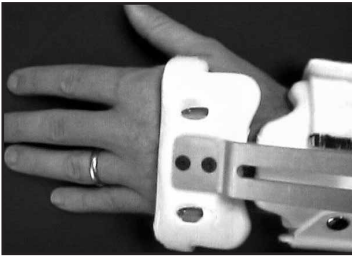

Figure 1

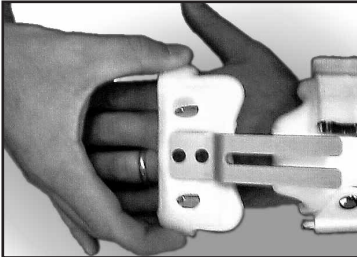

Figure 2

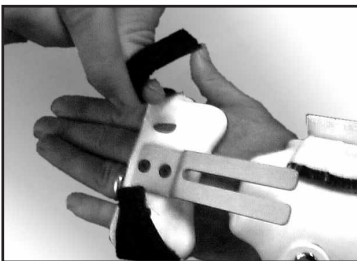

Figure 3

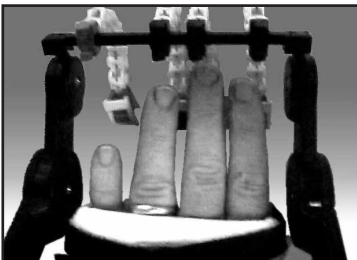

Figure 4

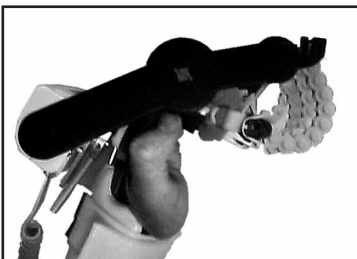

Figure 5

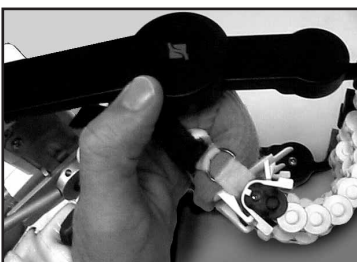

Figure 6

MP Block (Intrinsic Minus Position)

1. Apply WaveFlex splint as with typical setup with end of splint aligning with MP joints (figure 1).
2. Extend splint by pulling on distal and proximal ends. The end of the splint should be positioned in-between the MP and PIP joints (figure 2).
3. Next, apply the volar only block, part number 6416, by placing it under the fingers and attaching the long black Velcro straps to the splint (figure 3).
4. The MP joints are now blocked from both extension and flexion. Move the WaveFlex motor so that the axis point (large black circular area) is aligned with the PIP joints. This is critical, as the force of the motor needs to be concentrated on the PIP joints, not the MP joints (figure 4).
5. In flexion the device should look like this. The axis is on the PIP and the fingers are flexed at the DIP and PIP only. Make sure you adjust the flexion ROM on the controller to match this limited arc of motion (figure 5).
6. This setup can be accomplished by using all clip attachment methods including the Silipos digital cap (as shown) or to the preference of the clinician, patient or you (figure 6).

6000X CPM Setup and Operating Manual

Patient Setup Instructions (cont'd)

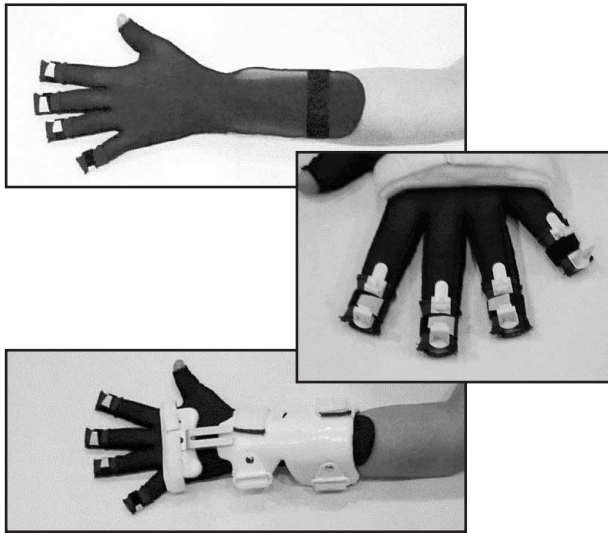

Glove Directions for Use

Select the correct glove size for the patient. Attach the Velcro pad on the underside of the four clips. Attach the clips to the fingertips on top of the nails and loosely secure with the Velcro strap. Ensure the large end of each clip is at the tip of the finger. Also ensure Velcro straps are even with the middle of each fingernail. Slip the glove onto the patient's hand. Make sure the tips are positioned so the clips are over the fingernails. Adjust the straps again to have the clips firmly secured. Attach the finger clips to the glove. Smooth out the glove wrist tab with the Velcro facing up. Attach the splint on top of the glove and adjust the splint shape in order to fit the patient's forearm before securing the Velcro straps on the splint.

(Gloves are available for the left and right hand in sizes small, medium and large)

SPECIAL ATTENTION WARNING:

Complying with the following instructions will help reduce unnecessary wear and damage to the Waveflex 6000X.



1. **ALWAYS** use the Hand Controller to run the device to adjust the position of the Drive Bar and Finger Actuators.



2. **DO NOT** force the actuator to move by hand by pushing on the Drive Bar. **This action breaks the gears in the transmission and requires the gear motor to be replaced.** This action also breaks the Arm Drive Gear Support Pins and requires that each damaged Bridge Arm assembly be replaced.

If damage occurs due to above actions, send the device in to be repaired and recalibrated.

6000X CPM Setup and Operating Manual

Programming Instructions

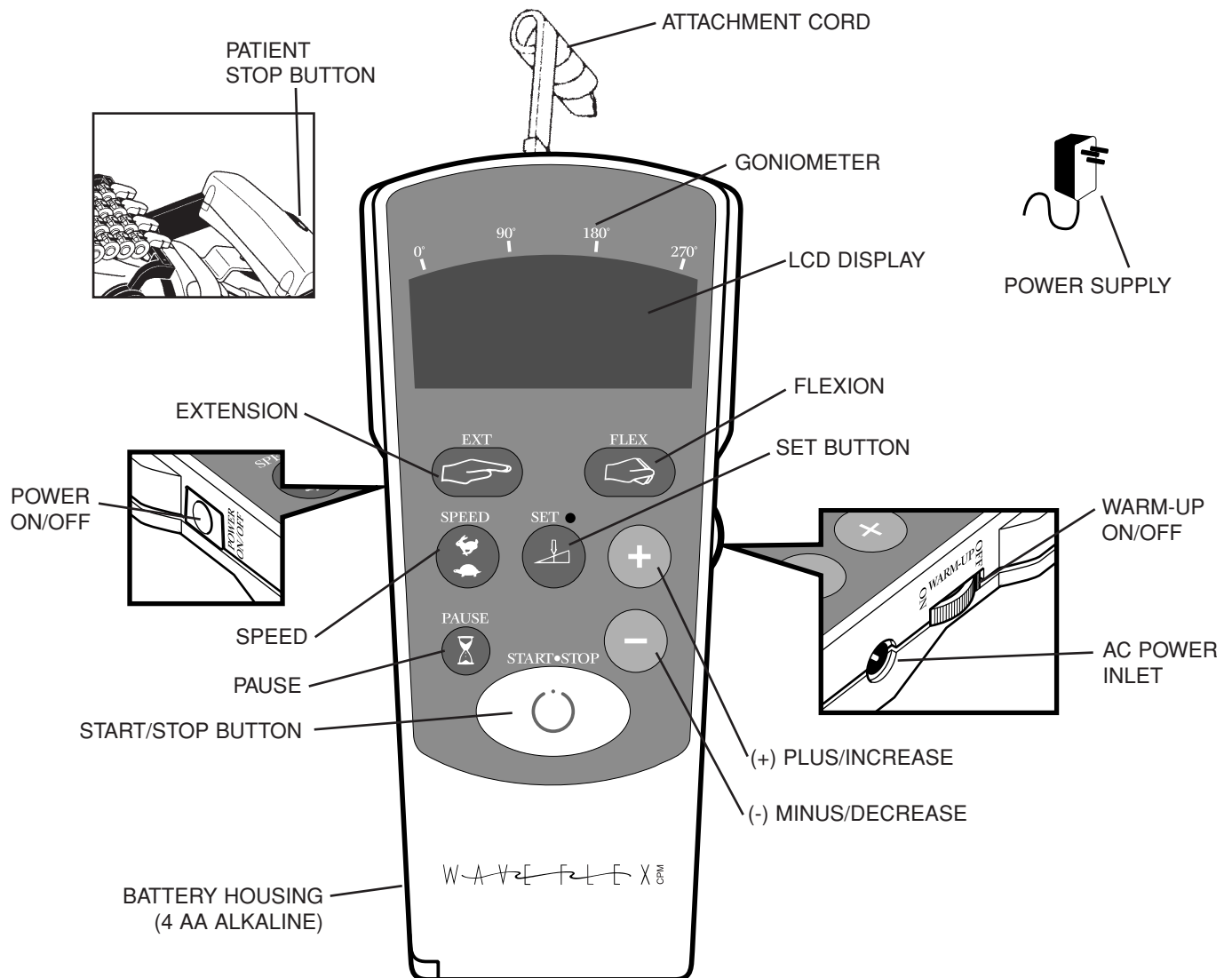

Before Programming

1. Ensure the device is completely assembled prior to operation.
2. Attach the cable from the Motion Controller to the CPM Actuator.
3. Install batteries, or plug the AC adapter into the Motion Controller and a grounded wall outlet.
4. Turn the device On and Off from the POWER ON/OFF button on the Motion Controller. The LCD window displays the current range of motion position of the device.
5. Before programming the CPM, ensure the device is not running. If it is, stop the device by pressing the START/STOP button on the Motion Controller.

Programming Instructions (cont'd)

Programming Range of Motion

Step 1: Turn the device on by pressing the POWER ON/OFF button on the hand controller. The Controller momentarily flashes all the system icons and then permanently displays the present range of motion.

Step 2: Press the SET button (system icons flash). The yellow SET light will appear indicating that the controller is ready to receive new programming.

Step 3: To program extension press the EXT button. The LCD will display the extension icon and the currently programmed extension setting.

Step 4: To program the desired amount of extension, press the + or - buttons to increase or decrease the range.

Step 5: To program flexion press the FLEX button. The flexion icon will appear in the LCD display.

Step 6: To program the desired amount of flexion press the + or - buttons to increase or decrease the range.

Step 7: Once programming is complete, press the SET button again to store the settings in the controller's memory (yellow light will go off). Or, continue setting other operating features.

Step 8: To begin treatment start the device by pressing the START/STOP button on the hand controller.

Programming Speed

Step 1: With power on, press the SET button. The yellow light will appear indicating that the controller is ready to receive new programming. The LCD will flash all the system icons.

Step 2: Press the SPEED button. The LCD now only displays the SPEED icon and the currently programmed speed setting. There are four Speed settings: 1 is the slowest, indicated by a tortoise, and 4 is the fastest, indicated by a hare.

Step 3: To increase or decrease speed, press the + or - buttons.

Step 4: When programming is complete, press the SET button again to store the settings in the controller's memory (yellow light will go off). Or, do not press the SET button but continue setting other operating features.

Programming Pause

Step 1: With power on, press the SET button. The yellow light will appear indicating that the controller is ready to receive new programming. The LCD will flash all the system icons.

Step 2: Press the PAUSE button. The LCD will only display the pause icon (hourglass) and the two EXT and FLEX hand icons.

Step 3: Select flexion or extension by depressing either the EXT or FLEX button. Press the + or - buttons to change the pause setting from 0 to 30 seconds. Pause may be set independently in flexion and/or extension.

Step 4: When programming is complete press the SET button again to store the settings in the controller's memory (yellow light will go off). Or, do not press the SET button but continue setting other operating features.

Warm Up Feature

The Warm Up feature starts the patient off with 50% less range of motion than programmed and gradually works up to the full range of motion over several cycles (i.e. if programmed range is 0 to 120° treatment would begin at half the range, 30 to 90°, and gradually work up to the full range.) While Warm Up feature is on Hand Controller, settings are locked out.

Step 1: Turn power off from the POWER ON/OFF button on the hand controller.

Step 2: Place the Warm Up feature switch in the ON position and then turn the power on from the POWER ON/OFF switch again. The thermometer Warm-Up feature icon will appear in the LCD display.

Step 3: When ready, start the device from the START/STOP button.

Programming Instructions (cont'd)

Hidden Features

WARNING: The Following are *NOT* for Patient Use

Reverse on Load, Lock-Out and Patient Compliance are features to be set by the medical care giver only. Use by the patient could result in injury.

Reverse on Load Force Settings

The Reverse on Load setting is programmed by the medical care giver to meet the treatment requirements of each patient. This feature is hidden from the patient for safety reasons.

Step 1: Turn power off from the POWER ON/OFF button.

Step 2: Simultaneously press and hold the SPEED button and POWER ON button. The Force icon will be displayed and the flexion and extension icons will blink. (1 is lowest force setting, 5 is highest force setting).

Step 3: Select which range you wish to set force in by choosing flexion or extension. Force may be set independently in both flexion and extension.

Step 4: With the + or - buttons increase or decrease Force setting.

Step 5: Press the SET button to program the new Force settings.

Lock-Out Feature

The Lock-Out feature allows the medical care giver to effectively lock out settings to prevent a patient from making adjustments. If any of the features are locked out, the Lock-Out icon is displayed at all times.

Step 1: Turn power off from the POWER ON/OFF button.

Step 2: Simultaneously press the SET button and POWER ON button. The Lock Out icon will flash.

Step 3: Select and press the button of the operating feature(s) you wish to lock out. The icon of each feature you lock out will appear. You may lock out one feature or all features.

Step 4: Press the SET button when finished to set lock outs.

Unlocking the Lock-Outs: Repeat Steps 1 and 2 on how to set the Lock Out feature. Select the operating feature(s) you wish to unlock and press the corresponding unlock and press the corresponding button(s). The feature's icon will disappear from the LCD. Press the SET button when finished.

Patient Compliance Meter

The Compliance Meter is used to monitor the number of treatment hours a patient receives.

Step 1: Turn power off from the POWER ON/OFF button.

Step 2: Press and hold the PAUSE button and the POWER ON button simultaneously. The display represents the number of hours the device has been used (to the closest hour). To reset the Meter to 0 hours for the next patient, press and hold the - key until 0 hours is displayed. The device will now begin counting usage hours from 0. The Meter counts to a maximum of 999 hours after which it must be reset.

6000X CPM Setup and Operating Manual

Symbols, Specifications and Ordering Information

Symbols



Extension



Speed



Battery Stop



Flexion



Plus/
Increase



Low
Battery



Start/Stop



Minus/
Decrease



Lock-Out



Setting



Force



Warm-Up



Pause



Attention:
Consult
accompanying
documents



For use with
indicated power
supply only



Type 'B'
applied part



Danger Explosive Risk:

If used with flammable anaesthetic



Caution: FDA Policy. Federal U.S. Law restricts this device to sale by or on the order of a licensed healthcare practitioner.



**This
Way Up**



Fragile



**Keep
Dry**

Ordering Information

VHB Tape	6304
Attachment Tape	FBA-006
Finger Clips	6305

Splints	
<i>Small</i>	6301
<i>Large</i>	6302

Finger Actuators	
<i>Small (blue)</i>	6508
<i>Medium (black)</i>	6507
<i>Large (white)</i>	6506
<i>Kit, Lock for Finger Clip</i>	H6KAC01

MP Block Kit	6417
--------------	------

Glove	
<i>Small Left</i>	6511
<i>Small Right</i>	6512
<i>Medium Left</i>	6513
<i>Medium Right</i>	6514
<i>Large Left</i>	6515
<i>Large Right</i>	6516

Silipos Digital	
Cap Kit (includes D-Ring Strap)	H6K-105
Silipos Digital Cap (2 per bag)	9105

*Alternative to using the glove or VHB pads.
Provides a soft silicone interface that reduces
pressure and diminishes scar tissue.*

Specifications

Device Weight

Drive Assembly	.45 kg (1 lb.)
Hand Controller	.20 kg (0.45 lb.)
Patient Kit	.21 kg (0.46 lb.)

Range of Motion (ROM)

MCP: 0° - 90° PIP: 0° - 110° DIP: 0° - 70°

Warm-Up Device cycles between 50% of last programmed limits to full limits, incrementally increasing ROM on each cycle

Speed (programmable) 30 to 120 seconds per cycle

Pause Independently programmable from 0 to 30 seconds in extension and/or flexion.

Reverse-on Load Force 1.6 kg (3.5 lbs.) low to 4.3 kg (9.5 lbs.) high

Lock-Out Programmable hidden feature keeps the patient from changing the settings.

User Compliance Hidden feature monitors patient therapy time. This can be cleared after each use.

Electrical

Power Rating: 5V, 1A

Power Supply: Battery 6V-4AA or use Power Supply WSA150M.
Input: 100-240VAC, 50/60Hz 40VA
Output: 5VDC, 2.5A

Fuse Rating: 1.5 A PTC resistor, non serviceable.
Reset by removing power.

Environmental

Storage/Shipping conditions:

Ambient Temperature	-40°C to +70°C (-40°F to 158°F)
Relative Humidity	10% to 100%
Atmospheric Pressure	500 hPa to 1060 hPa

Operating Conditions:

Ambient Temperature	10°C to 40°C (50°F to 104°F)
Relative Humidity	30% to 75%
Atmospheric Pressure	700 hPa to 1060 hPa

Cautions and Warnings

- Use the device only in accordance with the Physician prescription and Setup and Operating Manual. Failure to do so may result in damage to the device and/or personal injury.
- The device must not be used in the presence of flammable anesthetics.
- Use only manufacturer's supplied replacement components.
- Do not use the device if there are mental or physical conditions that preclude patient compliance.
- To prevent potential physical injury, such as strangulation and choking hazards, keep the device away from children or individuals with mental or physical conditions that preclude the safe use of the device.
- Position the device in a comfortable and secure position. Ensure that the device is stable through its full range of motion.
- Keep hair, loose clothing, fingers and all parts of body away from moving components of the device.
- Do not expose the device to water or extreme temperatures. See recommended Specifications: Environmental Conditions.
- Do not use the device near exposed flames, while smoking or near excessive heat.
- Disconnect the electrical supply before servicing or cleaning. Failure to do so could result in electrical shock or personal injury.
- Turn the power off before unplugging.
- Unplug the power supply by grasping the plug, not the cord.
- Unless using the device, turn the device off and unplug the power supply.
- Do not use the device power supply or controller if it appears damaged or if there are exposed wires.
- Do not pour cleaning solution directly onto the device. This may allow fluids to enter the device and cause electrical problems, or wash lubricants away from running components, reducing the life span of the device.
- Select a location for the device and device components (controller, straps, cables and power supply) to prevent a tripping hazard during use or storage.

Contraindications

Do not use the device if any of the following are present:

- Untreated or uncontrolled infection
- Unstable fractures
- Hemorrhage

Note: Upon using the device, if signs of infection such as hyperthermia, fever, redness, irritation, warmth, swelling, bleeding, and/or increased persistent pain are present, discontinue operation of the device and contact the patient's physician. Do not proceed with treatment until the physician has approved continued use of the device.

Maintenance

Maintenance by Patients

- Patients are responsible for using the device according to the Setup and Operating Manual. Do not wash softgoods.

Maintenance Between Patients

- Softgoods for the device are for single patient use only and cannot be washed for reuse.
- Check the entire device for any visible evidence of damaged such as bent components, cracked or broken covers, frayed or damaged wires, etc. If any signs of damage are found, the device must be repaired before use.
- Ensure that all knobs and/or levers are usable and in place.
- Ensure that all moving components move freely as required.
- Check all displays and electronic controls for proper operation.
- Check all mechanical pivot and linkage points for smooth operation and secure mechanical connection. Make sure all screws, nuts, bolts, rivets, pivot pins, and other fasteners are secure.
- Gently wipe clean all exposed surfaces with a soft cloth dampened with a mild soap solution or alcohol. Do not use abrasive cleansers. To disinfect, wipe all exposed surfaces with a 10% solution of bleach and water, or other suitable disinfectant.
- Ensure that all labels are present.
- Replace the patient softgoods kit.
- Verify that the device operates to its set limits over several complete cycles.
- For Range of Motion (ROM) settings verify device calibration by observing the ROM of the device while taking visual reading using a goniometer at the device's anatomic pivot points. Compare the ROM settings of the device with the goniometer readings. ROM readings should be within +/- 5° of the set parameters. If the readings do not fall within the set parameters, the device needs to be checked and recalibrated by a properly trained Service Technician.

Maintenance Every Six Months

- Repeat steps under "Maintenance Between Patients".

Maintenance Every Twelve Months

- Verify electrical ground continuity where applicable from the device frame to ground pin of the power supply, if so equipped, using a Safety Analyzer or appropriate device.
- Repeat "Maintenance Between Patients" procedures.

Maintenance Every Eighteen Months

- A full inspection of the device by a properly trained Service Technician is recommended every 18 months.
- Repeat steps "Maintenance Every Twelve months".
- Fully inspect all internal and external mechanical and drive components, and repair or replace as necessary.
- Fully inspect all internal and external electrical components (including wire connectors and solder joints), and repair or replace as necessary.
- Perform a complete recalibration and subsequent check of electronic and mechanical safety systems including Reverse-On-Load function and Range of Motion controls.
- Complete a final check of the device in accordance with OrthoAgility inspection criteria. (These are available through your OrthoAgility representative, OrthoAgility Customer Service, or your local distributor.)

Sterilization

- This device does not require sterilization for use.
- Exposing the device to sterilization conditions will damage the device and may result in a potential hazard.

6000X CPM Setup Operating Manual

Warranty

New Product Limited Warranty

To obtain warranty service, the product must be returned freight prepaid to the Company or the selling distributor with a clear indication as to the defect. Upon receipt of a product returned under warranty, the Company will inspect the product and will notify the buyer of the extent of repair or replacement which the Company will perform under warranty. If the product is received incomplete, missing parts will automatically be replaced at the buyer's expense. The Company also reserve the right, at its sole election and own cost, to upgrade or replace parts or sub-assemblies to the latest production standards. The Company will normally perform the repair and return the product, or provide a replacement, within (30) days from the day of receipt, freight collect.

THE COMPANY IS NOT RESPONSIBLE FOR LOSS OF USE, LOST PROFITS, OR SPECIAL, INCIDENTAL OR CONSEQUENTIAL DAMAGES RESULTING FROM THE BREACH OF THIS WARRANTY, THE FAILURE OF ANY PRODUCT OR THE NEGLIGENCE BY THE COMPANY IN THE PERFORMANCE OF ANY SERVICE, INCLUDING DAMAGES FOR PERSONAL INJURY. THE WARRANTY CONTAINED HEREIN IS IN LIEU OF ALL WARRANTIES, EXPRESSED OR IMPLIED, INCLUDING IMPLIED WARRANTIES OF MERCHANTABILITY AND FITNESS FOR A PARTICULAR PURPOSE. NO STATEMENT OF ANY REPRESENTATIVE SHALL EXTEND THE COMPANY'S LIABILITY AS HEREIN ESTABLISHED OR LIMITED. THIS WARRANTY IS PROVIDED TO THE ORIGINAL PURCHASER OF THE PRODUCT AND IS NON-TRANSFERRABLE.

Returning the Device for Service

Should the device require warranty repair, buyer must contact either the Customer Service department (outside the USA contact International Customer Service), or the authorized distributor from which the device was purchased for return instructions.

If any warranted product is found by the company to have a defect covered by this warranty, the company shall, at its option, either repair the defective item or install a replacement.

If the device needs to be returned for any repair, pack the components in the original shipping container and contact:

In the USA:

QAL Medical, LLC®
Attn: Technical Service
Tel: 715-735-4727; 888-430-1625
Website: www.qalmedical.com

International Customer Service:

QAL Medical, LLC®
Attn: Customer Service
3000 Woleske Road
Marinette, Wisconsin 54143 USA
Tel: 1-715-735-4727 Fax: 1-715-732-6402
E-mail: info@qalmedical.com

Note: Please enclose the following information when returning the device:

- Return Authorization Number
- Ship-to Address
- Purchase order for non-warranty repairs
- Name and phone number of a person to contact
- Brief description of the problem

Notes:

CUSTOMER CONTACTS:

In the USA:

QAL Medical, LLC®

Website: www.galmedical.com

Tel: 1.715.735.4727; 1.888.430.1625 Fax: 1.715.732.6402

International:

QAL Medical, LLC®

3000 Woleske Road, Marinette, Wisconsin 54143 USA

Tel: 1.715.735.4727 Fax: 1.715.732.6402



QAL Medical, LLC®

3000 Woleske Road, Marinette, Wisconsin 54143 USA

Tel: 1.715.735.4727; 1.888.430.1625 Fax: 1.715.732.6402

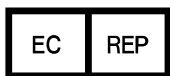

Russell Square Quality Representatives, Ltd.

Ludgate House, 107-111 Fleet Street, London EC4A 2AB

info@rsqr.co.uk www.rsqa.co.uk



QAL Medical is registered to ISO 13485 for Quality Assurance