

LED Full Cut-Off Wall Pack Series

Wattages: 45W, 70W / Tunable Wattages: 30W/45W/60W/70W

LED Full Cut-Off Wall Pack series can be widely used in indoor or outdoor lighting (wet location). Ideal for mechanical or electronic processing workshops, storage warehouses, steel mills, gas stations, toll booth, waiting rooms, the platforms of railway station, indoor stadiums.



WATT/CCT
FIELD-ADJUSTABLE

FEATURES

- Lumileds LED, high luminous efficiency and long working life.
- High efficiency LED Driver, the wide range input voltage AC120-277V/AC 347V.
- Excellent optics design, greatly improve the light utilization and evenness.
- Motion sensor control available (Optional)
- 1-10V Dimming.

Die-cast aluminum cooling design, high quality and better cooling for LED Tj < 85°C.



| SPECIFICATION | | | |
|---------------------|-------------------------|----------|------------------------------|
| WATTAGE | 45W | 70W | 30W/45W/60W/70W |
| LUMEN | 6756 lm | 10500 lm | 4216 / 6139 / 7882 / 8980 lm |
| EFFICACY | 150 lm/W | 150 lm/W | 130 lm/W |
| CCT | 4000K, 5000K | | 3000K/4000K/5000K |
| CRI | 70 | | 70 |
| INPUT VOLTAGE | 120-277V / 347V | 120-277V | 120-277V |
| POWER FACTOR | 0.95 | | 0.95 |
| DRIVER EFFICACY | 90% | | 90% |
| DIMMING | 1-10V Dimming | | 1-10V Dimming |
| LIGHT ANGLE | 82° X 102° | | |
| LIFE SPAN | 75,000 hrs | | |
| WORKING TEMPERATURE | -22°F ~ 113°F | | |
| STORAGE TEMPERATURE | -40°F ~ 176°F | | |
| OUTDOOR RATING | Wet location | | |
| CABLE | Input Connect, No cable | | |
| WARRANTY | 5 year limited | | |

LED Full Cut-Off Wall Pack Series

Wattages: 45W, 70W / Tunable Wattages: 30W/45W/60W/70W

DIMENSION

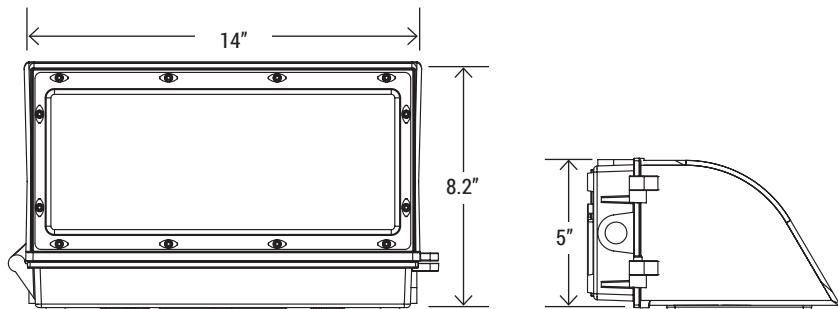

| | |
|------------|-----------------|
| WATTAGE | 45W |
| NT. WEIGHT | 6.4 lbs/carton |
| BOX DIM. | 14" x 8.2" x 5" |

| | |
|------------|-----------------|
| WATTAGE | 70W |
| NT. WEIGHT | 6.61 lbs/carton |
| BOX DIM. | 14" x 8.2" x 5" |

| | |
|------------|-----------------|
| WATTAGE | 30W/45W/60W/70W |
| NT. WEIGHT | 6.26 lbs/carton |
| BOX DIM. | 14" x 8.2" x 5" |

EMERGENCY BACK-UP (SOLD SEPARATELY)



BLD-CM20N-480800-8W
8W Emergency Backup Battery LED Driver

BLD-CM20N-480800-15W
15W Emergency Backup Battery LED Driver

BLD-CM20N-480800-20W
20W Emergency Backup Battery LED Driver

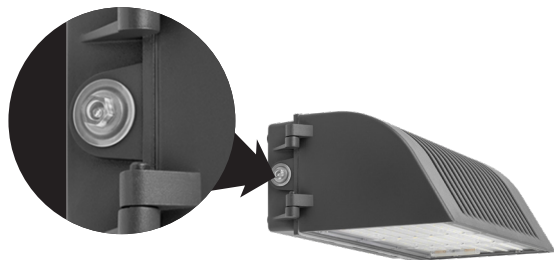

CONTROLS (SOLD SEPARATELY)

P (Photocell)



WATT/CCT
FIELD-ADJUSTABLE

ORDERING INFORMATION

EXAMPLE:

WSD-FWP-07W-27-50K-P

| WSD | FWP | 07W | 27 | 50K | D | P |
|-------------|----------------------------------|---|---|--|---|-----------------|
| COMPANY | PRODUCT | WATTAGE | VOLTAGE | CCT | FINISH | CONTROL |
| WSD LED INC | FWP Full Cut-Off Wall Pack | *45W - (45W) 07W - (70W) 34567W - (30W/45W/ 60W/70W) | 27 (AC120-277V) *347 (AC347V) | 40K - (4000K) 50K - (5000K) 345K - (3000K/4000K/5000K) | D - (Dark Bronze) W - (White) B - (Black) S - (Silver) | P - (Photocell) |

LED Full Cut-Off Wall Pack Series

Wattages: 45W, 70W / Tunable Wattages: 30W/45W/60W/70W

PHOTOMETRICS

For complete IES files, please visit our website.

WSD-FWP-45W-50K

LUMINOUS INTENSITY DISTRIBUTION DIAGRAM

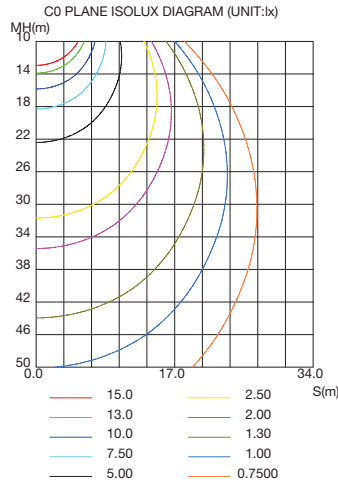
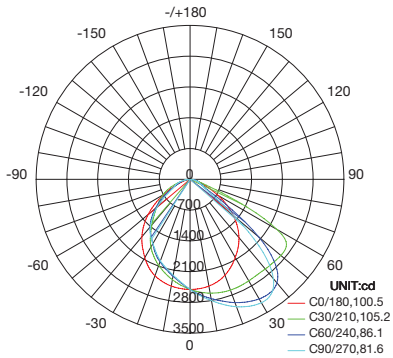

ISOLUX DIAGRAM

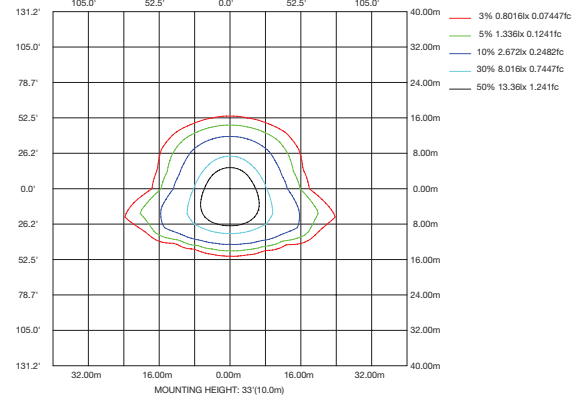

WSD-FWP-70W-50K

LUMINOUS INTENSITY DISTRIBUTION DIAGRAM

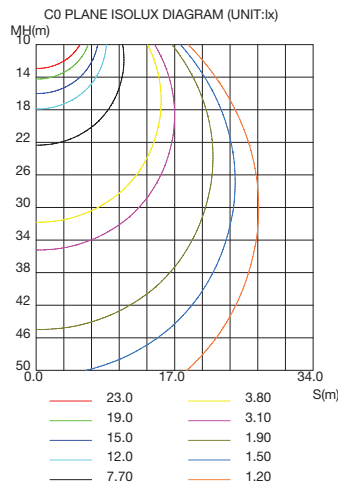
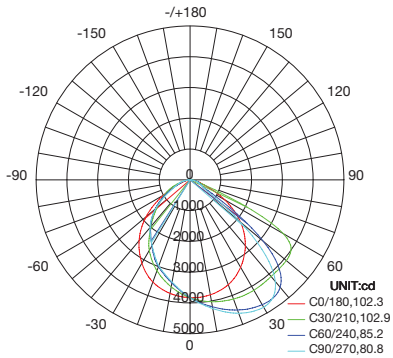

ISOLUX DIAGRAM

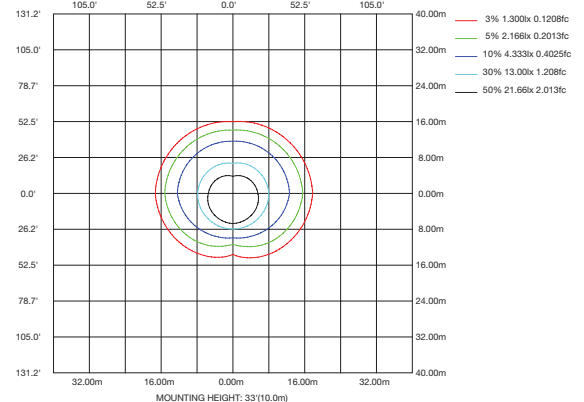

WSD-FWP-34567W-50K (SHOWN IS 70W@5000K)

LUMINOUS INTENSITY DISTRIBUTION DIAGRAM

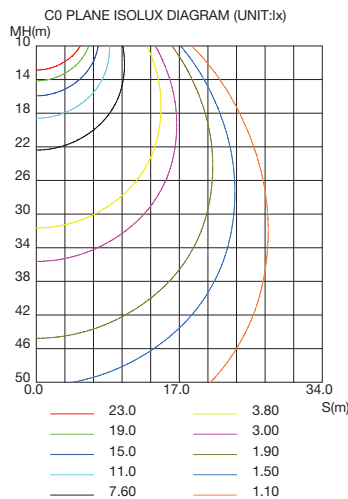
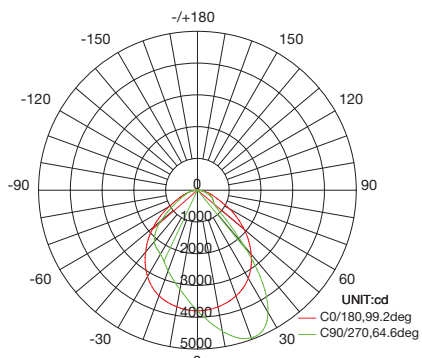

ISOLUX DIAGRAM

