

Instructions for Use

Edition USA



CE
0297

implantmed^{PLUS}

SI-1010 / SI-1015 / SI-1023

Contents

Symbols	4
1. Introduction	8
2. Electromagnetic compatibility (EMC)	10
3. Unpacking	11
4. Scope of delivery	12
5. Safety notes	13
6. Description	20
of front panel.....	20
of rear panel	21
of foot control S-N2/S-NW	22
of motor with cable	24
7. Start-up	25
8. Control unit	26
9. Starting operation	27
10. Control unit operation	28
Main menu.....	28
Menue Navigation	31
Factory settings.....	36
Documentation with USB stick.....	42
ioDent® platform	44
Beacon	46
11. Error messages	47

Contents

12. Hygiene and maintenance	50
General notes	50
Limitations on processing.....	51
Initial treatment at the point of use	52
Manual cleaning	53
Manual disinfection	54
Automated cleaning and disinfection	55
Drying.....	56
Inspection, maintenance and testing	57
Packaging.....	58
Sterilization	59
Storage	61
13. Servicing	62
14. W&H accessories and spare parts	64
15. Technical data	67
16. Disposal	69
W&H course certificate	70
Explanation of warranty terms	73
Authorized W&H service partners	74
Manufacturer's declaration	75

Symbols

in the Instructions for Use



WARNING!
(if persons could be injured)



ATTENTION!
(if property could be damaged)



General explanations,
without risk to persons or property



Thermo washer disinfectable

















Sterilizable
up to the stated temperature



Type B applied part (not suitable for
intracardiac application)

Symbols

on the control unit

	Follow Instructions for Use		Class II equipment		Catalogue number
	Date of manufacture		Foot control		Serial number
	Do not dispose of with domestic waste		On / Off	V	Supply voltage of the control unit
	DataMatrix code for product information including UDI (Unique Device Identification)		Electric fuse	AC	Alternating current
	CE marking with identification number of the Notified Body		Medical Device	VA	Power consumption of the control unit
	MEDICAL – General medical equipment as to electrical shock, fire and mechanical hazards only in accordance with ANSI/AAMI ES 60601-1:2005, ANSI/AAMI ES60601-1: A1:2012 + C1:2009/(R)2012 + A2:2010/(R)2012, CAN/CSA-C22.2 No. 60601-1:2008, CSA CAN/CSA-C22.2 NO. 60601-1:2014. 25UX – Control No.		Earth	A	Supply current
				Hz	Frequency of the alternating current
				rpm	Revolutions per minute (= rpm)

Symbols

on the packaging

 CE marking
with identification number
of the Notified Body

 This way up

 Fragile, handle with care

 Keep dry

 »Der Grüne Punkt« [The Green
Dot] trademark of Duales System
Deutschland GmbH

 Trademark of RESY OfW GmbH
for identification of recyclable
transport and outer packaging
of paper and cardboard

 DataMatrix code
for product information including UDI
(Unique Device Identification)

 Data structure in accordance with
Health Industry Bar Code

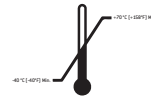
 Temperature limitation

 Humidity,
limitation

 Caution! According to Federal law restricts this
device to sale by or on the order of a physician,
dentist, veterinarian or with the descriptive
designation of any other practitioner licensed
by the law of the State in which the practitioner
practices to use or order the use of the device.

Symbols

on the irrigation tubing set

	CE marking with identification number of the Notified Body		Not for re-use		Latex-free
	Batch code		Use by		Sterilization with ethylene oxide
	Catalogue number		Manufacturer		Keep away from heat
	Do not re-sterilize		Do not use when package is damaged		DataMatrix Code for product information including UDI (Unique Device Identification)
	Caution! According to Federal law restricts this device to sale by or on the order of a physician, dentist, veterinarian or with the descriptive designation of any other practitioner licensed by the law of the State in which the practitioner practices to use or order the use of the device.				Data structure in accordance with Health Industry Bar Code

1. Introduction



For your safety and the safety of your patients

These Instructions for Use explain how to use your product. However, we must also warn against possible hazardous situations. Your safety, the safety of your team and, of course, the safety of your patients, are of paramount importance to us.



Observe the safety notes.

Intended use

Mechanical drive unit with coolant supply for transmission instruments with ISO 3964 (DIN 13940) compatible coupling system, for use in dental surgery, implantology and maxillofacial surgery (CMF) for treatment of dental hard tissue.



Misuse may damage the medical device and hence cause risks and hazards for patients, users and third parties.

Qualifications of the user

Only suitably qualified medical, technical and specialist trained staff may use the medical device.

We have based our developed and design of the medical device on the »physician« target group.

Introduction



Production according to EU Directive

The medical device complies with the regulations of Directive 93/42/EEC.

Responsibility of the manufacturer

The manufacturer can only accept responsibility for the safety, reliability and performance of the medical device when compliance with the following instructions is ensured:

- > The medical device must be used in accordance with these Instructions for Use.
- > The medical device has no components that can be repaired by the user.
- > Modifications or repairs must only be undertaken by an authorized W&H service partner (see page 74).
- > The electrical installation at the premises must comply with the regulations laid out in IEC 60364-7-710 (“Installation of electrical equipment in rooms used for medical purposes”) or with the regulations applicable in your country.
- > Unauthorized opening of the control unit invalidates all claims under warranty and any other claims.

In addition to unauthorized assembly, installation, modification of or repairs to the control unit, motor with cable, transmission instrument and non-compliance with our instructions, improper use will void the warranty and release us from all other claims.



Any serious incident that has occurred in relation to the medical device should be reported to the manufacturer and the competent authority!

2. Electromagnetic compatibility (EMC)



Medical electrical device is subject to particular precautions with regards to EMC and must be installed and put into operation in accordance with the EMC notes included.

W&H only guarantees compliance of the device with the EMC Directives when it is used with original W&H accessories and spare parts. The use of accessories and spare parts that have not been approved by W&H may lead to increased emission of electromagnetic interference or to reduced resistance to electromagnetic interference.

HF communication equipment

Portable HF communications equipment (including peripherals such as antenna cables and external antennas) should be used no closer than 30 cm (12 inches) to the medical device. Otherwise, degradation of the performance of this medical device could result.

The medical device may be interfered by other equipment, even if these other devices comply with CISPR (International special committee on radio interference) emission requirements.

Use of this medical device adjacent to or stacked with other equipment should be avoided because it could result in improper operation. If such use is necessary, this medical device and the other equipment should be observed to verify that they are operating normally.

The medical device is not intended for use in the vicinity of HF surgical devices.

3. Unpacking

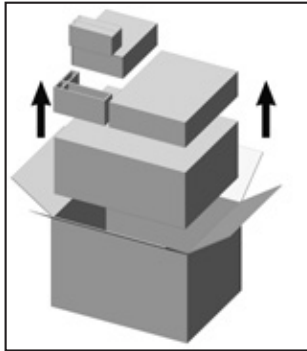

❶ Remove the packaging.

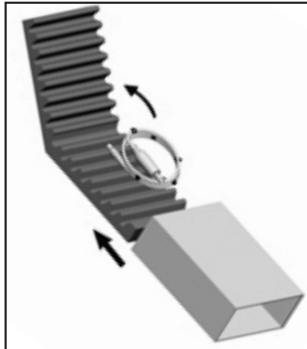

❷ Remove the motor with cable.

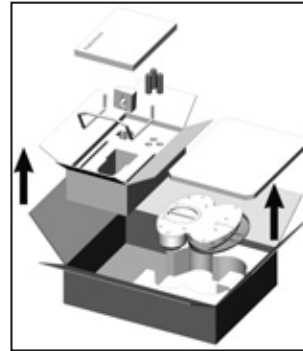

❸ Remove the foot control, Instructions for Use and accessories.

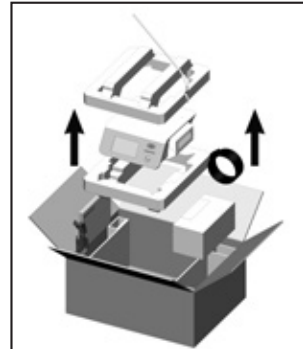

❹ Lift out the insert with the control unit. Remove the mains cable, irrigant support, universal support, irrigation tubing set and Instructions for Use.

W&H packaging is environmentally friendly and can be disposed of by industrial recycling companies. However, we recommend that you keep the original packaging.

4. Scope of delivery

Control unit		SI-1023 (230V) 30288000	SI-1015 (120V) 30289000	SI-1010 (100V) 30290000
REF 436360	Irrigation tubing set 2.2 m (3 pcs, disposable)		X	
REF 07721800	Universal support		X	
REF 04005900	Irrigant support		X	
Mains cable country-specific			X	

Optional included in set

REF 30281000	EM-19 LC motor with electrical contacts and 1.8 m cable
REF 30185000	EM-19 motor without electrical contacts with 1.8 m cable
REF 30264000	Foot control S-NW
REF 30285000	Foot control S-N2
REF 07759700	SPI dongle



- > Before using the medical device for the first time, store it at room temperature for 24 hours
- > Check the medical device and the motor with cable for damage and loose parts every time before use.
- > Do not operate the medical device and the motor with cable if it is damaged.
- > Check the parameter settings every time the device is restarted.
- > Perform a test run prior to every treatment.
- > The responsibility for the use and timely shutdown of the system lies with the user.
- > Ensure that it is possible to complete the operation safely should the units or instruments fail.



The medical device is not approved for operation in potentially explosive atmospheres.



Do not twist or kink the motor cable! Do not coil it too tightly!
Moisture in the motor with cable may cause a malfunction! (Risk of short circuit)



- > Use only original W&H fuses.
- > Never touch the patient and the electrical connections on the control unit simultaneously.
- > Make sure that no computer viruses are transferred to the control unit by an external data medium (USB stick).



The connection of a USB hard drive with an external power source is not permitted.



The control unit is classed as »conventional equipment« (closed equipment without protection against the ingress of water).



Use the WS-75 and WI-75 (20:1) ratios exclusively with the contra-angle handpieces approved by W&H. Use of other contra-angle handpieces may result in deviation from the indicated torque. The user alone is therefore responsible for the above. The manufacturer does not accept any liability.



Power failure

In the event of a power failure, if the control unit is switched off, or when switching between programs, the last values set are saved and re-activated on power-up.

System failure

A total system failure does not constitute a critical fault.



Mains cable / Power switch

- > Only use the mains cable supplied.
- > Plug the mains cable only into an earthed power socket.
- > Set up the control unit so the power switch and the socket are easily accessible at all times.



Disconnect the control unit from the power supply in case of danger.

- > Turn off the control unit at the power switch.
- > Pull the power plug out of the socket.



Rotational energy

Deceleration of the bur can, cause the selected torque to be temporarily exceeded, compared to the value set, as a result of the rotational energy stored in the drive system.



Observe the manufacturer's speed and torque specifications for retaining screws for superstructures. Adjusting these retaining screws with an electric motor presents a potential risk as described above.

Note that when using or setting low speeds, the operation or run-down of rotary instruments is more difficult to detect.

-  **Risks due to electromagnetic fields**
The functionality of implantable systems, such as cardiac pacemakers and implantable cardioverter defibrillator (ICD), can be affected by electric, magnetic and electromagnetic fields.
- > Find out if patient and user have implanted systems before using the medical device and consider the application.
 - > Weigh the risks and benefits.
 - > Keep the medical device away from implanted systems.
 - > Do not place the motor on the patient's body.
 - > Make appropriate emergency provisions and take immediate action on any signs of ill-health.
 - > Symptoms such as raised heartbeat, irregular pulse and dizziness can be signs of a problem with a cardiac pacemaker or ICD.

Foot control

-  Follow the directions and safety notes in the Instructions for Use of the foot control.

Foot control S-NW

-  Keep the ORANGE button depressed to switch between the control units



The medical device is designed for use with physiological saline solution.



- > Always ensure correct operating conditions and that sufficient and adequate coolant is delivered.
- > Always provide sufficient coolant and ensure the appropriate suction.
- > Use only suitable coolants and follow the manufacturer's medical data and instructions.
- > Use the W&H irrigation tubing set or accessories approved by W&H.

Irrigation tubing set



Sterile disposable irrigation tubing sets are supplied with the equipment.



- > Note the expiration date and only use disposable irrigation tubing with undamaged packaging.
- > Replace the disposable irrigation tubing immediately after every treatment.
- > Follow your local and country-specific laws, directives, standards and guidelines for disposal.

Safety notes



Transmission instrument

- > Follow the directions and safety notes in the Instructions for Use of the transmission instrument.
- > Only use transmission instruments with an ISO 3964 (DIN 13940) compatible coupling system and manufacturer approved transmission instruments.
- > Follow the directions of the manufacturer of transmission instrument with reference to transmission ratio, maximum speed and maximum torque.

Safety notes

Hygiene and maintenance prior to initial use



- > Clean and disinfect the control unit, the motor with cable, the universal support and the irrigant support.
- > Sterilize the motor with cable and the universal support.

Test run



Do not hold the motor with transmission instrument at eye level.

- > Connect the transmission instrument to the motor. Point the transmission instrument with the head facing downwards.
- > Operate the motor with the foot control.



- > In the event of operating malfunctions (e.g. vibrations, unusual noises or overheating), stop the motor immediately and contact an authorized W&H service partner.

6. Description

of front panel

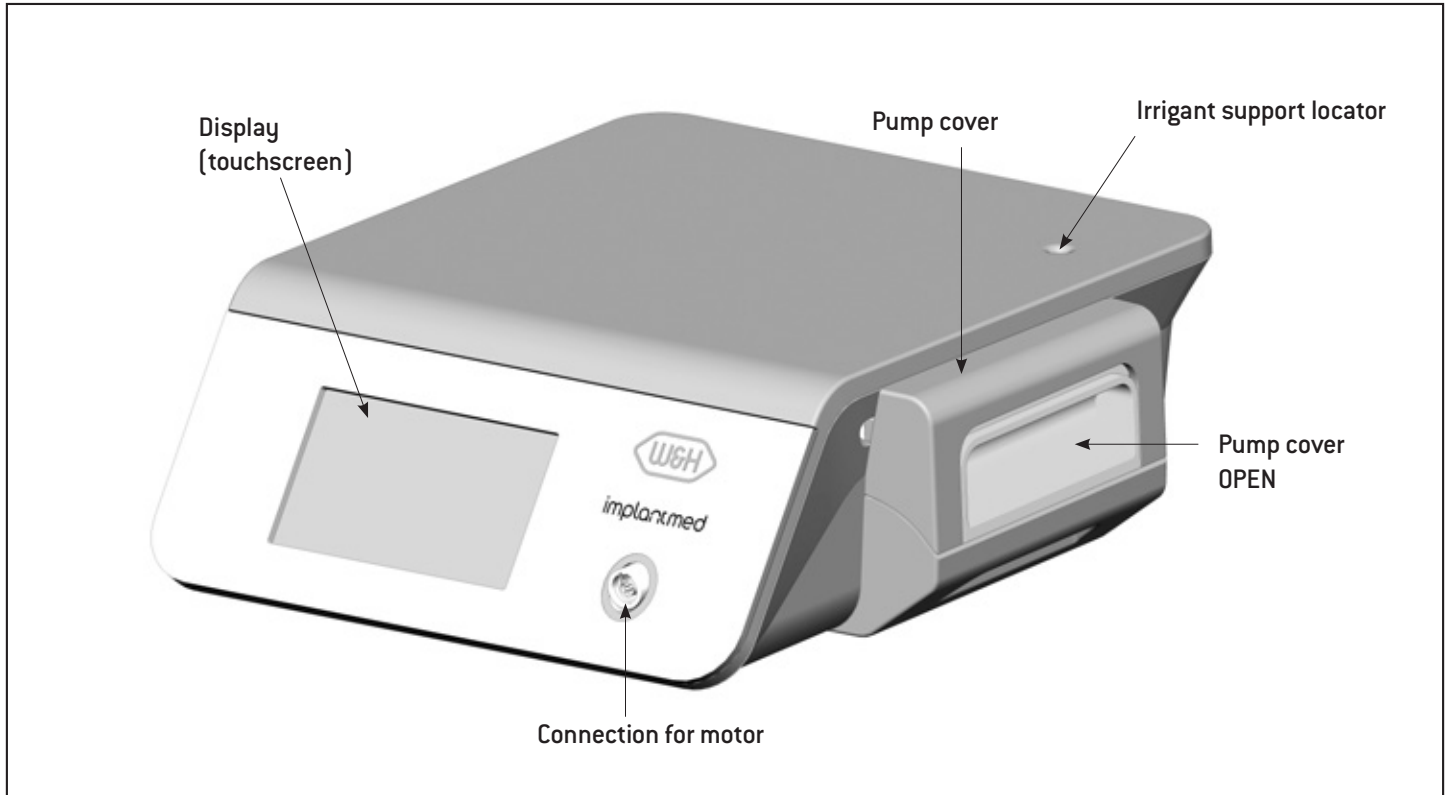

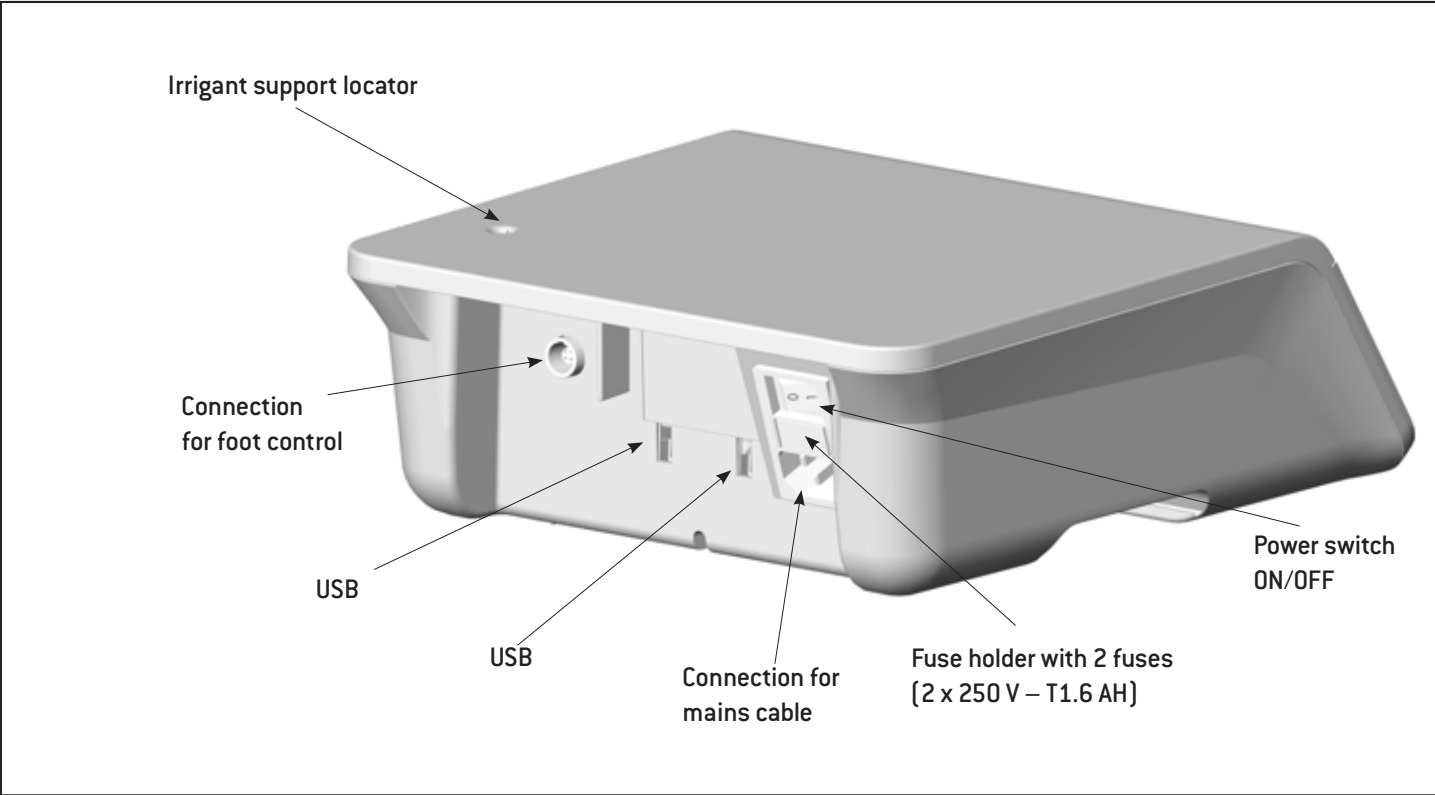

Description

of foot control S-N2/S-NW

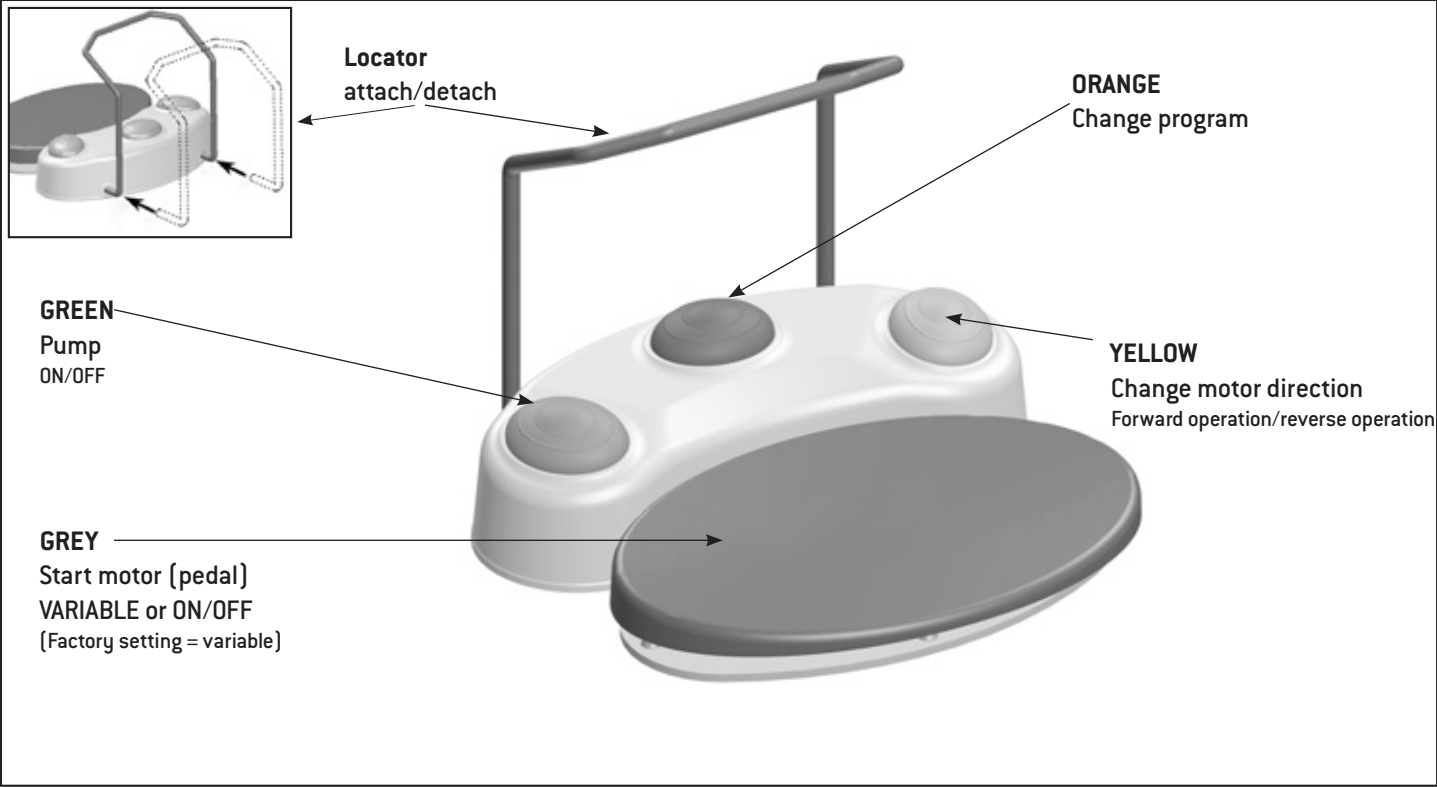

Description

of foot control S-N2/S-NW

ORANGE

S-N2 / S-NW: Change program

Press the ORANGE button to change programs in ascending order. The motor direction is automatically set to forward operation every time the program is changed.



When changing from the last program to the first program a longer acoustic signal sounds (risk of injury).

ORANGE

S-NW: Switching between multiple control units

Press the ORANGE button for 3 seconds

GREEN – pump ON/OFF

Only when the motor is stationary can the pump be switched on or off by pressing the GREEN button of the foot control.

YELLOW – change motor direction

Forward operation/reverse operation

Press the YELLOW button to change from forward operation to reverse operation. A signal sounds on selection and the “Forward/reverse operation mode” symbol flashes. Before the motor starts in reverse operation, 3 audible signals are given.

Description

of motor with cable



The motor with cable must not be disassembled!

The motor with cable must not be oiled (pre-oiled for entire service life)!

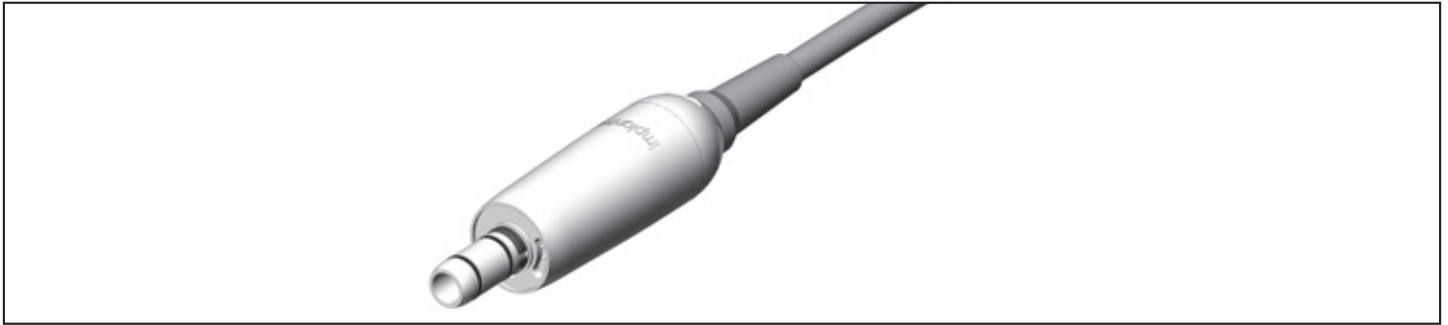

The motor with cable is a type B applied part (not suitable for intracardiac application).



Temperature information

Temperature of the motor on the operator side: max. 55°C (131°F)

7. Start-up



Place the medical device on a flat level surface.



Ensure that the medical device can be disconnected from the power supply at any time.

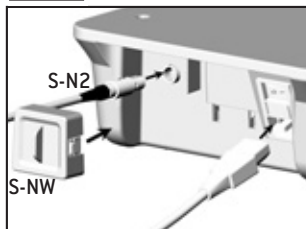

- 1** Connect the mains cable and foot control.

 Pay attention to the positioning!



- 2** Connect motor cable.

 Pay attention to the positioning!

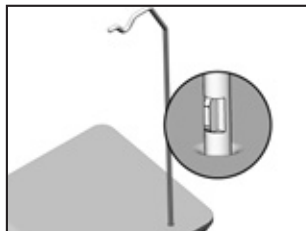

- 3** Insert the irrigant support.

 Pay attention to the positioning!
(Maximum load capacity 1.5 kg)



- 4** Attach the universal support and lock it.

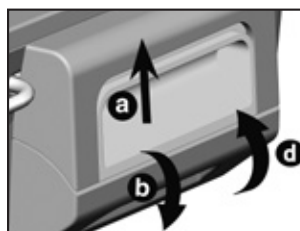

- 5** Insert the irrigation tubing.

> Open the pump cover (a,b).
> Insert the irrigation tubing (c).

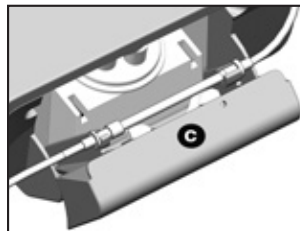

> Close the pump cover (d).

8. Control unit

switching on and off



Switching on the control unit

- 1 Plug the mains cable into an earthed power socket.



- 2 Switch on the control unit at the power switch.



Switching off the control unit

- 1 Switch off the control unit at the power switch.



- 2 Pull the power plug out of the socket.



The touch screen must only be touched using fingers.

Using hard objects on the touch screen may scratch or damage the surface.

Setting up Implantmed

Switch on your control unit and follow the directions of the setup wizard.

The set-up wizard guides you through the various set-up stages up to the main menu:

> **Language selection**

> **Set Up Medical Device:**

Customized: Create a user

Standard: Default settings

10. Control unit operation

Main menu

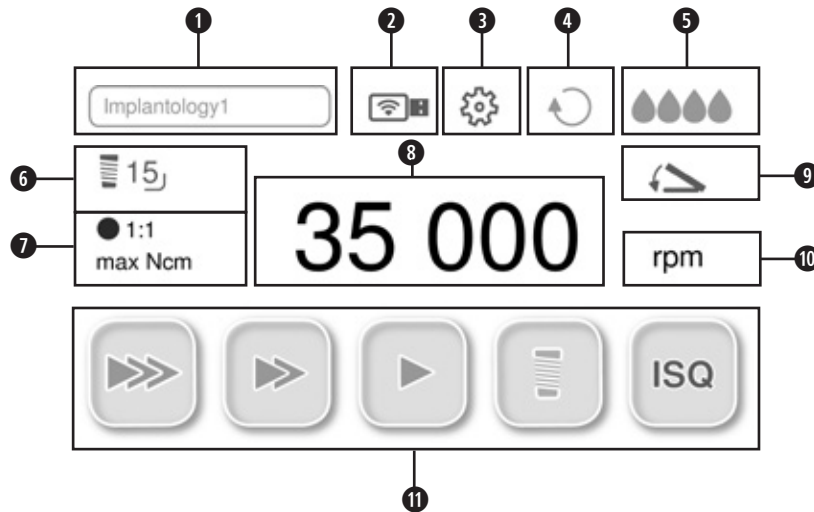

①	My favorites	⑦	Set program
②	Documentation / Wi-Fi Pairing	⑧	Set speed / torque
③	Setup	⑨	Foot control
④	Forward/reverse operation mode	⑩	Progress display mode
⑤	Set coolant volume	⑪	Programs
⑥	Tooth position		

Control unit operation

My favorites



Select drill protocol group

An activated drill protocol cannot be deleted



Edit

> Adjust factory setting of drill protocol groups.

> Create drill protocol



Copy



Rename



Activate



Delete

Control unit operation

16
● 1:1
max. 50 Ncm

Set program



Transmission

rpm Speed

At 40,000 rpm the accuracy of the set speed is $\pm 10\%$.

Ncm Torque

Adjustment range 5 – 80 Ncm with WI-75 and WS-75 only.

The motor switches off automatically when the set torque is reached in forward and reverse operation modes.

The accuracy of the set torque in the 20 – 50 Ncm range for the W&H WI-75 and WS-75 contra-angle handpieces is $\pm 10\%$. Greater deviations may be encountered with other contra-angle handpieces.



Documentation

DOCU only appears once the documentation has been started.

rpm
{Ncm}

Progress display mode



Bar





Percent

100

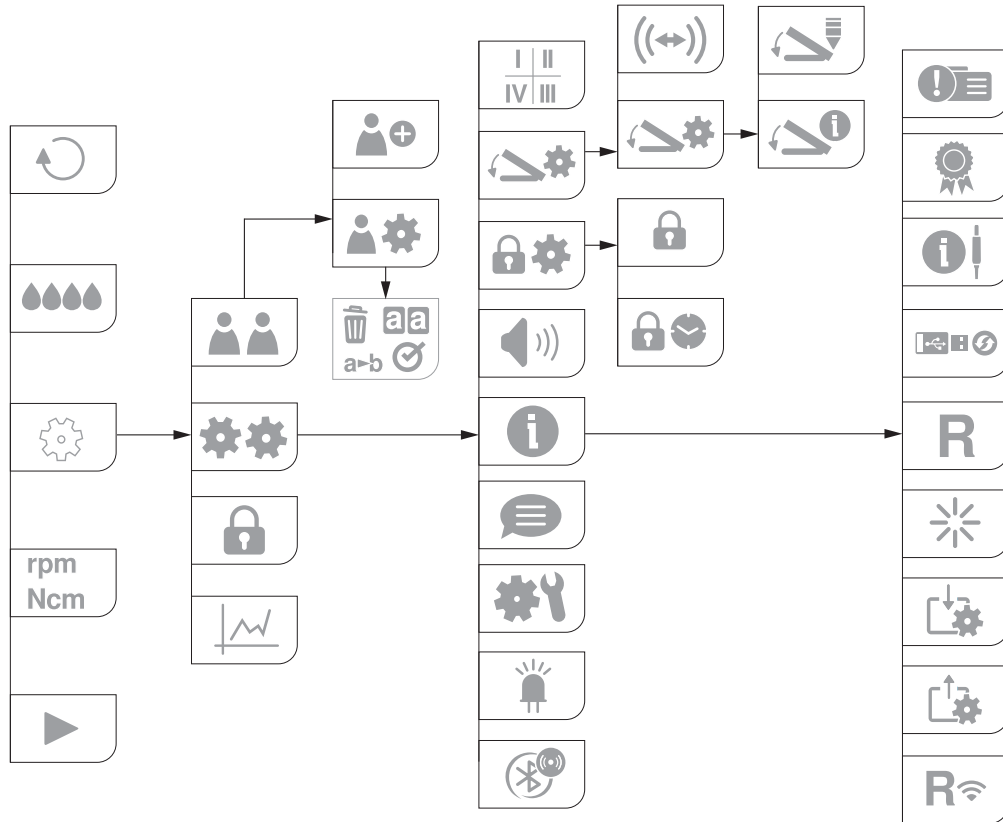
Total



Control unit operation

 **User**
 An activated user cannot be deleted

 **Add user**

 **Manage user**
User settings: Copy, Rename, Activate, Delete

 **Foot control**

 **Pairing – S-NW**

 **Variable**

 **ON/OFF**

 **System**

 **Torque curve**

 **Set screen lock**
Activating / deactivating screen lock

 **Screen lock**

 **Interval**
Interval: Select time

 **LED**
Activating / deactivating LED

 **Fade-out time**
Select time

 **SOUND**
Activating/deactivating

 **Language**
Select language

Control unit operation



System check

Test run



Dental numbering system

Select dental numbering system: FDI / UNS

I–IV

FDI (Fédération Dentaire Internationale = International dental numbering system)

1–32

UNS (Universal Numbering System = American dental numbering system)



Switch between selected tooth positions (green)



Selected tooth position (black)



New position



New docu



Complete docu



Wi-Fi-dongle



Device info



Service



Licenes

GPL: GNU General Public License

LGPL: GNU Lesser General Public License



Module info



Osstell



User interface



Motor control unit

Control unit operation

 **Foot control**

 **Software update**

R  **Reset Wi-Fi pairing**

R **Reset**
Restore factory settings

 **Restart**
Control unit restarts automatically













 **Import user settings**

 **Export user settings**

 **Beacon**



 **Beacon Pairing**

Control unit operation

-  Confirm/save
-  Favorite selected
-  black = information
green = Information with selection option
-  red = error message, work cannot be continued
orange = error message, work can be continued
-  red = replace batteries
-  Foot control S-NW
-  Foot control S-N2
-  Drill function
-  Drill function
-  Drill function
-  Thread-cutter function
-  Implant insertion
-  ISQ Implant stability quotient measurement



Control unit operation

Factory settings

Implantology 1			
Transmission	1:1	WS-75 (20:1)	WS-75 (20:1)
Speed rpm	35,000	1,200	800
Setting range rpm	200 – 40,000	10 – 2,000	10 – 2,000
Motor direction of rotation	forward/reverse	forward/reverse	forward/reverse
Pump	on	on	on
Torque Ncm	100 %	100 %	100 %



Control unit operation

Factory settings

Implantology 1		
Transmission	WS-75 (20:1)	WS-75 (20:1)
Speed rpm	15	15
Setting range rpm	10 – 50	10 – 50
Motor direction of rotation	forward	reverse
Pump	off	off
Torque Ncm	20	50
Setting range Ncm	5 – 80	5 – 80





Control unit operation

Factory settings

Implantology 2			
Transmission	1:1	WS-75 (20:1)	WS-75 (20:1)
Speed rpm	35,000	1,200	800
Setting range rpm	200 – 40,000	10 – 2,000	10 – 2,000
Motor direction of rotation	forward/reverse	forward/reverse	forward/reverse
Pump	on	on	on
Torque Ncm	100 %	100 %	100 %



Control unit operation

Factory settings

Implantology 2				
Transmission	WS-75 (20:1)	WS-75 (20:1)	WS-75 (20:1)	WS-75 (20:1)
Speed rpm	20	20	15	15
Setting range rpm	10 – 50	10 – 50	10 – 50	10 – 50
Motor direction of rotation	forward	reverse	forward	reverse
Pump	on	on	off	off
Torque Ncm	20	60	20	50
Setting range Ncm	5 – 80	5 – 80	5 – 80	5 – 80

Control unit operation

Factory settings

Oral Surgery			
Transmission	1:1	1:1	1:2.7
Speed rpm	35,000	10,000	108,000
Setting range rpm	200 – 40,000	200 – 40,000	540 – 108,000
Motor direction of rotation	forward/reverse	forward/reverse	forward/reverse
Pump	on	on	on
Torque Ncm	100 %	100 %	100 %

Thread-cutter function (chip breaker mode)



When the pedal (grey) on the foot control is pressed, the thread cutter rotates inwards until the set torque is reached. The control unit automatically switches to reverse operation when the set torque is reached. Disengaging and then re-engaging the pedal will switch the control unit back to forward operation.



If the thread cutter function is in reverse operation mode, the control unit can also start with the maximum torque.

 Drill protocols, torque curves and ISQ values can only be documented in the thread-tapping function, implant insertion or ISQ measurement.

Documentation must be activated or deactivated for each program.

A USB stick is required to save the documentation.



> Never remove the USB stick while the motor is running.

> Never remove the USB stick during the measurement.

Record documentation

> Connect USB stick



Icon appears

> Enter ID

> Enter date

> Select tooth quadrant

> Select tooth

> Confirm selection



Documentation starts when the motor starts.

Further documentation

-  > Add new position
- > Start new docu
- > Complete docu



When the motor stops, a diagram appears, which is automatically saved to the USB stick.

Edit documentation

A text file (csv) and a PDF file are saved on the USB stick.
The text file can be opened in Microsoft® Excel®* for editing.
The pdf file can be opened in Adobe® Reader®**.

* Microsoft® Excel® is a registered trademark of the Microsoft® Corporation in the United States of America and/or other countries.

** Adobe® Reader® is a registered trademark of Adobe Systems Incorporated in the United States of America and/or other countries.



Follow the directions and safety notes in the Instructions for Use of the ioDent® platform.

Check the data exchange between the ioDent® platform and the medical device.



> Check the transferred data for completeness and correctness.

Establishing a connection to the ioDent® platform

- > Insert the ioDent® Wi-Fi dongle
- > The connection is established



The icon appears

If the icon is green: The documentation is active

If the icon is grey: The system is connected

If the icon is yellow: There is a connection problem



When the motor stops, a diagram appears, which is automatically saved to the ioDent® platform.

 Connecting the medical device to an IT network or changing an IT network can lead to previously unidentified risks to patients, operators or third parties. The operator of the IT network is responsible for identification, analyzing, evaluating and controlling these risks. Changes to the IT-Network include changes in the IT-network configuration, connection of additional items to the IT-Network, disconnecting items from the IT- Network, update of equipment connected to the IT-Network, and upgrade of equipment connected to the IT-Network.

	Not paired device	Paired device
Device IP-address	192.168.10.1	192.168.10.x (from Gateway DHCP-Server)
Device communication port	443 (TLS/SSL)	443 (TLS/SSL)
Device subnet	255.255.255.0	255.255.255.0
Device hostname	Implantmed	Implantmed
Gateway IP	192.168.10.x	192.168.10.1

Used network layers/protocols		
Application	Application layer	https
Transport	Transport layer	SSL/TLS TCP
	Network layer	IPv4
	Data link layer	Wi-Fi (IEEE 802.11)



Follow the directions and safety notes in the Instructions for Use for the Beacon.

Establishing a connection to the Beacon

- > Insert the Osstell dongle.

Beacon pairing (standard)

- > Only possible in the ISQ program.
- > All Beacons connect to the medical device automatically.

Beacon pairing using the serial number



- > Enter the serial number in the system settings.
- > Only the Beacon with the entered serial number can connect to the medical device.

Deleting Beacon pairing

- > Enter 0 to delete the stored serial number.





11. Error messages









The error message disappears when it is clocked or when the pedal (grey) on the foot control is released.

Icon	Description of error	Solution
	WARNING FOOT CONTROL	<ul style="list-style-type: none">> Check plug contacts of foot control> Check the plug contacts of the dongle
	WARNING MOTOR	<ul style="list-style-type: none">> Check the plug contacts of the motor> Allow motor to cool for at least 10 minutes
	WARNING STORAGE DEVICE <ul style="list-style-type: none">> Insufficient memory available> Unknown file system> The write protection is active> Unknown storage device	<ul style="list-style-type: none">> Plug in a USB stick with sufficient memory
	WARNING OVERHEATING	<ul style="list-style-type: none">> Switch off the control unit> Allow the control unit to cool for at least 10 minutes> Switch on the control unit

Error messages

Icon	Description of error	Solution
	WARNING TIME-OUT	<ul style="list-style-type: none"> > Release the pedal (grey) on the foot control > Allow motor to cool for at least 10 minutes
	SYSTEM ERROR	<ul style="list-style-type: none"> > Switch the control unit off and back on again <p data-bbox="730 464 805 509"></p> <p data-bbox="821 442 1444 509">If the error message appears again, contact an authorized W&H service partner immediately.</p>
	SYSTEM NOT PAIRED	<ul style="list-style-type: none"> > System is not paired with the gateway. > Please wait and if it occurs repeatedly contact an authorised service partner.
	WARNING OSSTELL	<ul style="list-style-type: none"> > Remove the ISQ module and then assembly or > Connect probe > Remove probe from a source of electromagnetic interference > Maintain a distance between the probe and the SmartPeg (3-5 mm) or > Switch the control unit off and back on again
	WARNING Wi-Fi CONNECTION	<ul style="list-style-type: none"> > Press the ioDent® Wi-Fi dongle symbol > Attempt to establish a connection with the Wi-Fi gateway again.

Error messages

Icon	Description of error	Solution
	WARNING CONNECTION	<ul style="list-style-type: none"> > Press the ioDent® Wi-Fi dongle symbol > Attempt to establish a connection with the ioDent® platform again.
	WARNING DATA RECEPTION	<ul style="list-style-type: none"> > Restart the data transfer on the ioDent® platform.
	WARNING TIME SYNCHRONISATION	<ul style="list-style-type: none"> > Restart the gateway > Insert the ioDent® Wi-Fi dongle again
	WARNING SYSTEM MONITORING	<ul style="list-style-type: none"> > Release the pedal (grey) on the foot control and press it again. > If the error occurs again, restart the device.
	WARNING IMPLANT DOCUMENTATION	<ul style="list-style-type: none"> > Maximum number of implants (8) for the active documentation has been reached.
	WARNING DOCUMENTATION ACTIVE	<ul style="list-style-type: none"> > Finish the current documentation on the device before starting a new one.
	WARNING SOFTWARE UPDATE FAILED	<ul style="list-style-type: none"> > Check the update files and copy the data to the USB stick again. > Insert the USB stick again. Restart the update.

- > If the described problem cannot be resolved, the unit will need to be inspected by an authorized W&H service partner.
- > In case of a total system failure, switch the control unit off and on again.



Follow your local and national laws, directives, standards and guidelines for cleaning, disinfection and sterilization.



> Wear protective clothing, safety glasses, face mask and gloves.



> Use only oil-free, filtered compressed air with a maximum operating pressure of 3 bar for manual drying.



Cleaning agents and disinfectants

- > Read the notes, follow the instructions and heed the warnings provided by the manufacturers of cleaning agents and/or disinfectants.
- > Use only detergents which are intended for cleaning and/or disinfecting medical devices made of metal and plastic.
- > It is imperative to comply with the concentrations and exposure times specified by the manufacturer of the disinfectant.
- > Use disinfectants which have been tested and found effective by the Verbund für Angewandte Hygiene e.V. (VAH = Association for Applied Hygiene), the Österreichischen Gesellschaft für Hygiene, Mikrobiologie und Präventivmedizin (ÖGHMP = Austrian Society for Hygiene, Microbiology and Preventive Medicine), the Food and Drug Administration (FDA) and the U.S. Environmental Protection Agency (EPA).
- > The user is responsible for validating its process if the specified cleaning agents and disinfectants are not available.



The product lifetime and the medical device's ability to operate correctly are mainly determined by mechanical stress during use and chemical influences due to processing.

- > Send worn or damaged medical devices and/or medical devices with material changes to an authorized W&H service partner.



Processing cycles

- > We recommend a regular service for the W&H motor with cable after 500 processing cycles or one year.
- > We recommend a regular service for the W&H universal support after 250 processing cycles.



- > Clean and disinfect the medical device immediately after every treatment.
- > Wipe the control unit, the motor with cable, the universal support and the irrigant support with disinfectant.



Note that the disinfectant used during pre-treatment is only for personal protection and cannot replace the disinfectant step after cleaning.

Motor with cable / Universal support / Irrigant support

-  > Do not immerse the motor with cable, the universal support or the irrigant support in liquid disinfectant or in an ultrasonic bath.

Motor with cable / Universal support / Irrigant support

- > Clean the motor with cable, the universal support and the irrigant support under running tap water (< 35°C / < 95°F).
- > Rinse and brush off all internal and external surfaces.
- > Remove any liquid residues using compressed air.



Control unit



- > Do not immerse the control unit in water or clean it under running water.



Foot control

- > The ESD spring contact on the bottom of the foot control must be cleaned regularly.

Motor with cable / Universal support / Irrigant support

-  > W&H recommends wipe-down disinfection.
-  Evidence of the basic suitability of the motor with cable, the universal support and the irrigant support for effective manual disinfection was provided by an independent test laboratory using the “mikrozyd® AF wipes” (Schülke & Mayr GmbH, Norderstedt) and “CaviWipes™” (Metrex).

Motor with cable / Universal support / Irrigant support



W&H recommends automated cleaning and disinfection using a washer-disinfector (WD).
Read the notes, follow the instructions and heed the warnings provided by the manufacturers of washer-disinfectors, cleaning agents and/or disinfectants.



> The control unit and foot control are not approved for automated cleaning and disinfection.



Evidence of the basic suitability of the motor with cable, the universal support and the irrigant support for effective automated disinfection was provided by an independent test laboratory using the “Miele PG 8582 CD” washer-disinfector (Miele & Cie. KG, Gütersloh) and the “Dr. Weigert neodisher® MediClean forte” cleaning agent (Dr. Weigert GmbH & Co. KG, Hamburg) according to ISO 15883.

- > Cleaning at 55°C (131°F) – 5 minutes
- > Disinfection at 93°C (200°F) – 5 minutes



Motor with cable / Universal support / Irrigant support

- > Ensure that the motor with cable, the universal support and the irrigant support are completely dry internally and externally after cleaning and disinfection.
- > Remove any liquid residues using compressed air.

Inspection – Motor with cable / Universal support / Irrigant support



- > Check the motor with cable, the universal support and the irrigant support after cleaning and disinfection for damage, visible residual soiling and surface changes.
- > Reprocess any motor with cable, universal support and irrigant support that are still soiled.
- > Sterilize the motor with cable and the universal support following cleaning and disinfection.

Motor with cable / Universal support



Wrap the motor with cable and the universal support in sterilization packages that meet the following requirements:

- > The sterilization package must meet the applicable standards in respect of quality and use and must be suitable for the sterilization procedure.
- > The sterilization package must be large enough for the sterilization goods.
- > The loading sterilization package must not be under tension.

Motor with cable / Universal support



W&H recommends sterilization according to EN 13060, EN 285 or ANSI/AAMI ST55.



- > Read the notes, follow the instructions and heed the warnings provided by the manufacturers of steam sterilizers.
- > The program selected must be suitable for the motor with cable and the universal support.

Recommended sterilization procedures

- > “Dynamic-air-removal prevacuum cycle” (type B) / “Steam-flush pressure-pulse cycle” (type S)*/**
134°C (273°F) for at least 3 minutes, 132°C (270°F) for at least 4 minutes
- > “Gravity-displacement cycle” (type N)**
121°C (250°F) for at least 30 minutes
- > Maximum sterilization temperature 135°C (275°F)

 Evidence of the basic suitability of the motor with cable and the universal support for effective sterilization was provided by an independent test laboratory using the LISA 517 B17L* steam sterilizer (W&H Sterilization S.r.l., Brusaporto (BG)), the Systec VE-150* steam sterilizer (Systec) and the CertoClav MultiControl MC2-S09S273** steam sterilizer (CertoClav GmbH, Traun).

“Dynamic-air-removal prevacuum cycle” (type B): 134°C (273°F) – 3 minutes*, 132°C (270 °F) – 4 minutes*/**
“Steam-flush pressure-pulse cycle” (type S): 134°C (273°F) – 3 minutes*, 132°C (270 °F) – 4 minutes*/**
“Gravity-displacement cycle” (type N): 121°C (250°F) – 30 minutes**

Drying times:

“Dynamic-air-removal prevacuum cycle” (type B): 132°C (270°F) – 30 minutes**
“Steam-flush pressure-pulse cycle” (type S): 132°C (270°F) – 30 minutes**
“Gravity-displacement cycle” (type N): 121°C (250°F) – 30 minutes**

* EN 13060, EN 285, ISO 17665

** ANSI/AAMI ST55, ANSI/AAMI ST79

Motor with cable / Universal support



- > Store sterile goods dust-free and dry.
- > The shelf life of the sterile goods depends on the storage conditions and type of packaging.

13. Servicing



Periodic inspection

Regular periodic inspection of the function and safety of the medical device is necessary and should be carried out at least once every three years, unless shorter intervals are prescribed by law.

The periodic inspection covers the complete medical device and must only be performed by an authorized service partner.

Servicing

Repairs and returns

In the event of operating malfunctions immediately contact an authorized W&H service partner.
Repairs and maintenance work must only be undertaken by an authorized W&H service partner.



> Ensure that the medical device has been completely processed before returning it.



- > Always return equipment in the original packaging.
- > Do not coil the cable around the motor and do not twist or kink the motor cable. (Risk of damage)
- > Foot control S-NW: Remove the batteries.

14. W&H accessories and spare parts



Use only original W&H accessories and spare parts or accessories approved by W&H.

Suppliers: W&H partners (Link: <https://www.wh.com>)

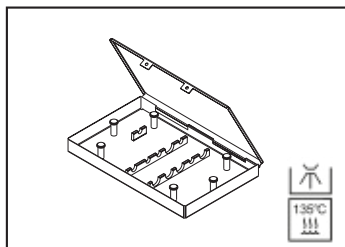

04013500

Sterilization cassette

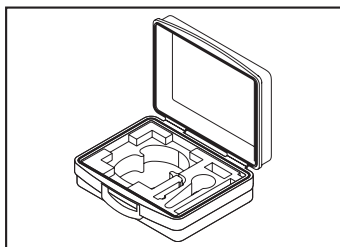

07962790

Transportation case



07721800

Universal support

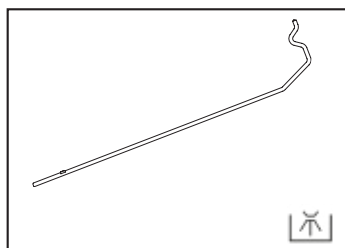

04005900

Irrigant support

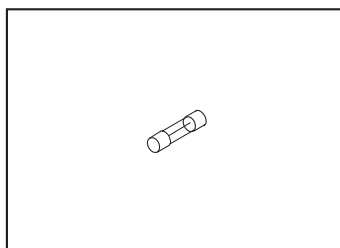

06352200

Fuse (250 V - T1.6AH)

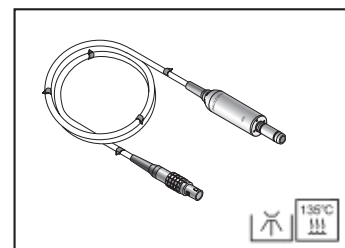

30281000

EM-19 LC motor with
electrical contacts
and 1.8 m cable

W&H accessories and spare parts

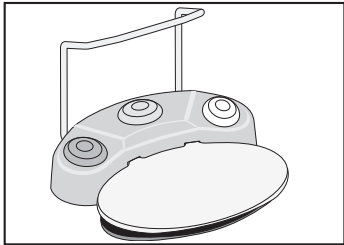

30285000

Foot control S-N2

30264000

Foot control S-NW

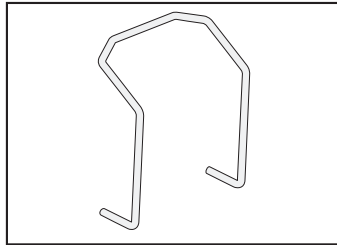

04653500

Locator for foot control

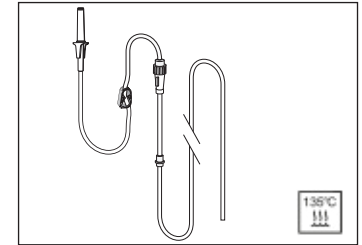

04719400

Irrigation tubing set 2,2 m

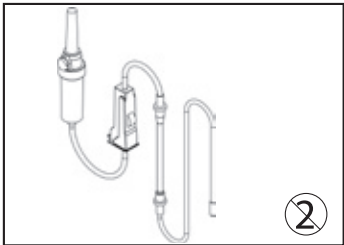

04363600

Irrigation tubing set 2.2 m (6 pcs)

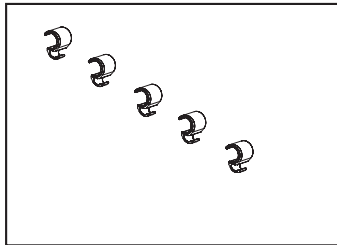

06290600

Hose clips (5 pcs)

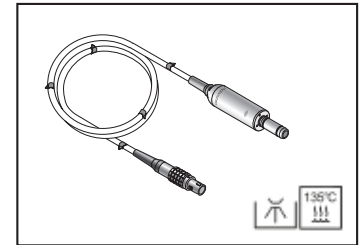

30185000

EM-19 motor without
electrical contacts
and 1.8 m cable

W&H accessories and spare parts



08026120

ioDent® Wi-Fi dongle



08026150

ioDent® gateway mini

15. Technical data

Control unit	SI-1023	SI-1015	SI-1010
Mains voltage:	230 V	120 V	100 V
Permissible voltage fluctuation:	220 – 240 V	110 – 130 V	90 – 110 V
Rated current:	0.3 – 0.8 A	0.3 – 1.6 A	0.3 – 1.4 A
Maximum power consumption:	170 VA		140 VA
Frequency:	50 – 60 Hz		
Mains fuse (2 pcs):	250 V – T1.6 AH		
Maximum power output:	80 W		
Maximum torque at motor:	6.2 Ncm		
Motor speed range in the rated voltage range:	200 – 40,000 rpm		
Coolant flow rate at 100%:	min. 90 ml/min		
Dimensions in mm (height x width x depth):	100 x 262 x 291		
Weight in kg:	3.5		

Ambient conditions

Temperature during storage and transport:	-40°C to +70°C (-40°F to +158°F)
Humidity for storage and transport:	8 % to 80 % (relative), non-condensing
Temperature in operation:	+10°C to +35°C (+50°F to +95°F)
Humidity in operation:	15 % to 80 % (relative), non-condensing

Technical data

Classification according to Paragraph 6 of the General Specifications for the Safety of Medical Electrical Device according to IEC 60601-1/ANSI/AAMI ES 60601-1



Class II medical electrical device (protective earth conductor used for functional earth connection only!)



Type B applied part (not suitable for intracardiac application)



S-N2 / S-NW are approved for operation in potentially explosive atmospheres.



S-N2 / S-NW are waterproof according to IPX8, 1 m depth of immersion, 1 hour (water-tight in accordance with IEC 60529)

Pollution level:	2
Overvoltage category:	II
Altitude:	up to 3,000 m above sea level

16. Disposal



Ensure that the parts are not contaminated on disposal.



Follow your local and country-specific laws, directives, standards and guidelines for disposal.

- > Medical device
- > Waste electrical equipment
- > Packaging

W&H course certificate

for the user

The user has been trained to use the medical device correctly in accordance with the legal regulations (medical devices marketing regulations, medical devices act). Particular attention has been paid to the chapters on safety notes, start-up, operation, hygiene and maintenance, and service (regular inspections).

Product name	Serial number (SN)
Manufacturer with address	
Distributor with address	

Name of the user	Date of birth and/or personnel number
Hospital/dental practice/department with address	
Signature of the user	
The signature confirms that the user has been trained to use the medical device and has understood the content.	

Name of the instructor	Date of instruction
Address of the instructor	
Signature of the instructor	



W&H course certificate

for the instructor

The user has been trained to use the medical device correctly in accordance with the legal regulations (medical devices marketing regulations, medical devices act). Particular attention has been paid to the chapters on safety notes, start-up, operation, hygiene and maintenance, and service (regular inspections).

Product name	Serial number (SN)
Manufacturer with address	
Distributor with address	



Name of the user	Date of birth and/or personnel number
Hospital/dental practice/department with address	
Signature of the user	
The signature confirms that the user has been trained to use the medical device and has understood the content.	



Name of the instructor	Date of instruction
Address of the instructor	
Signature of the instructor	

Explanation of warranty terms

This W&H product has been manufactured with great care by highly qualified specialists. A wide variety of tests and controls guarantees faultless operation. Please note that claims under warranty can only be validated when all the directions in the Instructions for Use have been followed.

As the manufacturer, W&H is liable for material or manufacturing defects within a warranty period of 24 months from the date of purchase. Accessories and consumables (universal support, coolant hose, irrigant support, fuse, locator for foot control, hose clips, mains cable, sterilization cassette) are not covered by the warranty.

We accept no responsibility for damage caused by incorrect handling or by repairs carried out by third parties not authorized to do so by W&H!

Claims under warranty – accompanied by proof of purchase, must be sent to the vendor or to an authorized W&H service partner. The provision of service under warranty extends neither the warranty period nor any other guarantee period.

24 months warranty

Authorized W&H service partners

Find your nearest authorized W&H service partner at <http://wh.com>
Simply go to the menu option “Service” for full details.

Or simply scan the QR code.



Manufacturer's declaration

Manufacturer's declaration

Electromagnetic compatibility (EMC)

WARNING: The use of cables, power supplies, accessories other than those specified by the manufacturer may result in increased emission and/or decreased immunity. Only use original W&H accessories.

cables and accessories country list	length	reference
Country specific mains cable according to W&H	2.5 to 3.1 m	Manufacturer: Feller GmbH
Motor with cable EM-19	1.8 m	Manufacturer: W&H REF 30185xxx
Motor with alternative cable EM-19	3.5 m	Manufacturer: W&H REF 30185xxx
Motor with cable (with LED) EM-19 LC	1.8 m	Manufacturer: W&H REF 30281xxx
Motor with alternative cable (with LED) EM-19 LC	3.5 m	Manufacturer: W&H REF 30281xxx
Foot controller S-N2	2.85 m	Manufacturer: W&H REF 30285xxx
Foot controller S-NW	Wireless transmission	Manufacturer: W&H REF 30284xxx
CAN Dongle	Wireless transmission	Manufacturer: W&H REF 07759700

Operate the product in a place with a maximum distance to electrical and magnetic interfering transmitters. If operation of the product close to other devices or together in a stack is necessary, observe the correct function of the system.

Electromagnetic immunity | Table 2, IEC 60601-1-2:2007

The product is suitable for use in a specific electromagnetic environment. The customer and/or the user of the product should assure that it is used in an electromagnetic environment as described below.

Immunity Test	IEC 60601-1 Level (3rd Ed.)	IEC 60601-1 Level (4th Ed.)	Compliance Level	Electromagnetic Environment Guidance
Electrostatic discharge (ESD) IEC 61000-4-2	± 8 kV contact ± 8 kV air	± 8 kV contact ± 15 kV air	± 8 kV contact ± 15 kV air	Floor should be wood, concrete or ceramic tile. If floors are covered with synthetic material, the relative humidity should be at least 30 %
Electrical fast transient/bursts IEC 61000-4-4	± 2 kV for power supply lines ± 1 kV for input/output lines 100kHz repetition rate	± 2 kV for power supply lines ± 1 kV for input/output lines 100kHz repetition rate	± 2 kV for power supply lines ± 1 kV for input/output lines Both repetition rates	Mains power quality should be that of a typical commercial and/or hospital environment
Surge IEC61000-4-5	± 1 kV line(s) to line(s) ± 2 kV line(s) to earth	± 1 kV line(s) to line(s) ± 2 kV line(s) to earth	± 1 kV line(s) to line(s) ± 2 kV line(s) to earth	Mains power quality should be that of a typical commercial and/or hospital environment
Voltage dips, short interruptions and voltage variations on power supply input lines IEC61000-4-11	<-5% U _r (>95% dip in U _r) for 0.5 cycle 40% U _r (60% dip in U _r) for 5 cycles 70% U _r (30% dip in U _r) for 25 cycles <-5% U _r (>95% dip in U _r) for 5 sec	0% U _r : 0.5 cycle @ 0°; 45°; 90°; 135°; 180°; 225°; 270° & 315° 0% U _r : 1 cycle and 70% U _r : 25/30* cycles @ 0° for 25 cycles 0% U _r : 250/300* cycle	Complies to both editions requirements	Mains power quality should be that of a typical commercial and/or hospital environment. If the user of the product requires continued operation during power mains interruptions, it is recommended that the product be powered from an uninterruptible power supply or a battery.
Power frequency(50/60 Hz) magnetic field IEC 61000-4-9	3A/m	30A/m	30A/m	Power frequency magnetic fields should be at levels characteristic of a typical location in a typical commercial or hospital environment.

* Note: U_r is the mains (AC) voltage before apply test levels
* 25/30 (250/300) means cycles at 50/60Hz

Manufacturer's declaration

Electromagnetic Immunity II (Table 4, IEC 60601-1-2:2007)

The product is suitable for use in a specific electromagnetic environment. The customer and/or the user of the product should assure that it is used in an electromagnetic environment as described below.

Immunity Test	IEC 60601-1-Level (3rd Ed.)	IEC 60601-1-Level (4th Ed.)	Compliance Level	Electromagnetic Environment Guidance
Conducted RF IEC 61000-4-6	3 V _{rms} 150 kHz to 80 MHz	3 V _{rms} 150 kHz to 80 MHz and amateur radio bands*	6 V _{rms}	Portable and mobile RF communications equipment should be used no closer to any part of the product, including cables, than the recommended separation distance calculated from the equation applicable to the frequency of the transmitter. Recommended separation distance: $d = 1,2 \sqrt{P}$
Radiated RF IEC 61000-4-3	3 V/m 80 MHz to 2.5 GHz	10 V/m 80 MHz to 2.7 GHz	10 V/m	$d = 1,2 \sqrt{P}$ for 80 MHz to 800 MHz $d = 2,3 \sqrt{P}$ for 800 MHz to 2.5 GHz where P is the maximum output power rating of the transmitter in Watt (W) according to the transmitter manufacturer and d is the recommended separation distance in meters (m) Field strengths from fixed RF transmitters, as determined by an electromagnetic site survey ^a , should be less than the compliance level ^b in each frequency range



Interference may occur in the vicinity of equipment marked with the symbol described lateral.

Note 1: At 80 MHz and 800MHz, the higher frequency range applies.

Note 2: These guidelines may not apply in all situations. Electromagnetic propagation is affected by absorption and reflection from structures, objects, people and animals.

* The ISM (industrial, scientific and medical) bands between 0,15 MHz and 80 MHz are 6,765 MHz to 6,795 MHz, 13,563 MHz to 13,567 MHz; 26,957 MHz to 27,283 MHz; and 40,66 MHz to 40,70 MHz. The amateur radio bands between 0,15 MHz and 80 MHz are 1,8 MHz to 2,0 MHz; 3,5 MHz to 4,0 MHz; 5,3 MHz to 5,4 MHz; 7 MHz to 7,3 MHz; 10,1 MHz to 10,15 MHz; 14 MHz to 14,2 MHz; 18,07 MHz to 18,17 MHz; 21,0 MHz to 21,4 MHz; 24,89 MHz to 24,99 MHz; 28,0 MHz to 29,7 MHz and 50,0 MHz to 54,0 MHz.

^a Field strengths from fixed transmitters, such as base stations for radio (cellular/cordless) telephones and land mobile radios, amateur radio, AM and FM radio broadcast and TV broadcast cannot be predicted theoretically with accuracy. To assess the electromagnetic environment due to fixed RF transmitters, an electromagnetic site survey should be considered, if the measured field strength in the location in which the product is used exceeds the applicable RF compliance level above, the product should be observed, additional measures may be necessary, such as reorienting or relocating the product.

^b Over the frequency range 150 kHz to 80 MHz, field strengths should be less than 3 V/m.

Manufacturer's declaration

Immunity level of RF fields from wireless communication devices (Table 9, IEC 60601-1-2:2014)						
Test frequency (MHz)	Band ^{a)} (MHz)	Service ^{a)}	Modulation ^{b)}	Maximum power (W)	Distance (m)	IMMUNITY TEST LEVEL (V/m)
450	430 – 470	GMRS 460, FRS 460	FM ^{c)} ± 5 kHz deviation 1 kHz sine	2	0.3	28
710	704 – 787	LTE Band 13, 17	Pulse modulation ^{b)} 217 Hz	0.2	0.3	9
745						
780						
810	800 – 960	GSM 800/900, TETRA 800, iDEN 820, CDMA 850, LTE Band 5	Pulse modulation ^{b)} 18 Hz	2	0.3	28
870						
930						
1720	1700 – 1990	GSM 1800; CDMA 1900; GSM 1900; DECT; LTE Band 1, 3, 4, 25;	Pulse modulation ^{b)} 217 Hz	2	0.3	28
1845						
1970						
2450	2400 – 2570	Bluetooth, WLAN, 802.11 b/g/n, RFID 2450, LTE Band 7	Pulse modulation ^{b)} 217 Hz	2	0.3	28
5240	5100 – 5800	WLAN 802.11 a/n	Pulse modulation ^{b)} 217 Hz	0.2	0.3	9
5500						
5785						

NOTE: If necessary to achieve the IMMUNITY TEST LEVEL, the distance between the transmitting antenna and the product may be reduced to 1 m. The 1 m test distance is permitted by IEC 61000-4-3.

a) For some services, only the uplink frequencies are included.
b) The carrier shall be modulated using a 50 % duty cycle square wave signal.
c) As an alternative to FM modulation, 50 % pulse modulation at 18 Hz may be used because while it does not represent actual modulation, it would be worst case.

Manufacturer's declaration

Recommended Separation Distances between portable and mobile HF- communications equipment and the product (Table 6, IEC 60601-1-2:2007)

The product is intended for use in an electromagnetic environment in which radiated RF disturbances are controlled. The customer or the user of the product can help prevent electromagnetic interference by maintaining a minimum distance between portable and mobile RF communications equipment (transmitters) and the product – according to output power and frequency of the communications equipment – as recommended in the following table.

Rated maximum output power of transmitter in watts (W)	Separation distance according to the frequency of transmitter in meter (m)		
	150 kHz to 80 MHz d = 1.2*P	80 MHz to 800 MHz d = 1.2*P	800 MHz to 2.5 GHz d = 2.3*P
0.01	0.12	0.12	0.23
0.1	0.38	0.38	0.73
1	1.2	1.2	2.3
10	3.8	3.8	7.3
100	12	12	23

For transmitters rated at a maximum output power not listed above, the recommended separation distance d in meters (m) can be estimated using the equation applicable to the frequency of the transmitter, where P is the maximum output power rating of the transmitter in watts (W) according to the transmitter manufacturer.

Note 1: At 80 MHz and 800MHz, the higher frequency range applies.

Note 2: These guidelines may not apply in all situations. Electromagnetic propagation is affected by absorption and reflection from structures, objects, people and animals.

Electromagnetic Emission (Table 1, IEC 60601-1-2:2007)

The product is suitable for use in a specific electromagnetic environment. The customer and/or the user of the product should assure that it is used in an electromagnetic environment as described below.

Emission Test	Compliance	Electromagnetic Environment Guidance
RF-emission CISPR 11	Group 1	The product use RF energy only for its internal function. Therefore, its RF emissions are very low and not likely to cause any interference in nearby electronic equipment. However, a separation distance of 30 cm shall be maintained.
RF-emission CISPR 11	Class B	The product is suitable for use in all establishments, including domestic establishments and those directly connected to the public low-voltage power supply network that supplies buildings used for domestic purpose.
Harmonic emissions IEC 61000-3-2 (*)	Class A	
Voltage fluctuations/ flicker emissions IEC 61000-3-3 (*)	complies	

(*) Remark: for devices with power consumption of 75 W to 1000 W only

Manufacturer

W&H Dentalwerk Bürmoos GmbH
Ignaz-Glaser-Straße 53, 5111 Bürmoos, **Austria**

t +43 6274 6236-0, **f** +43 6274 6236-55
office@wh.com **wh.com**

Form Nr. 50873 AAE
Rev. 005 / 13.01.2021
Subject to alterations