



IMPLANTOLOGY

product catalogue



2015

eighth Italian edition
seventh English edition



LEONE S.p.a.

ORTHODONTICS and IMPLANTOLOGY

Via P. a Quaracchi, 50
50019 Sesto Fiorentino
Firenze Italy
Phone +39.055.30.44.620
Fax +39.055.30.44.05
info@leone.it
www.leone.it



LEONE COMPANY

In 1934 the history of Leone originated from a small handcraft activity and today it is an industrial reality of high technological and commercial level. The productive and industrial area spreads out over a surface of around 10.000 sq. m., where 125 people operate.



RESEARCH

Most of the remarkable investments of the company are reserved to the Centre for Biotechnological Research “Marco Pozzi”, which is located inside the company. Studies on materials, surfaces and technical analysis for new products are carried out here. The collaboration with either Italian or foreign Universities and the Faculties of Engineering and Medicine and Surgery in Florence is very close. Training stages and scientific research are developed for the preparation of graduation thesis.



PRODUCTION

Engineers, mechanical and technical experts are making part of the manufacturing staff. Working side by side with the Centre for Biotechnological Research “Marco Pozzi” and making use of the most advanced technology, they are able to carry out the components of the two product ranges: orthodontics and implantology. All the innovations introduced in the production steps and the features of finished products are the result of consistent and in-depth studies as well as of remarkable investments.

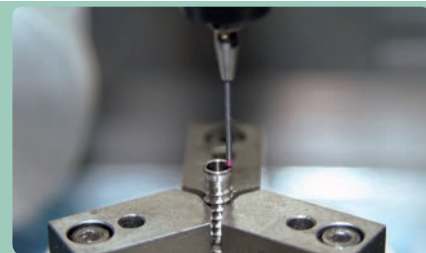

QUALITY PRODUCT CONTROL

The high quality of the Leone products is the result of sophisticated manufacturing techniques and accurate quality control conforming to UNI EN ISO 9001, ISO 13485, USA-FDA 21 CFR Part 820 rules and Japanese Ministerial Ordinance MHLW no. 169.



TECHNICAL AND COMMERCIAL ASSISTANCE

Contact your dealer in your country as a reference. You will find the comprehensive list under the section “distributors” in our website www.leone.it



LEONE S.p.a.

ORTHODONTICS and IMPLANTOLOGY



CUSTOMER SERVICE

LEONE is working non stop to satisfy the customer's expectations and is represented with dealers in 60 countries. A careful pre-sale and post-sale customer assistance is provided by qualified technical and commercial staff to meet any requirement.



WAREHOUSE

Finished and semi-finished products are stocked and organized by vertical lift automatic cabinets allowing a rationalization of the space and a fully computer based processing of the orders. Standard orders are shipped within 24 hours in Italy and 5-6 working days in the foreign country.



EDUCATION, TRAINING UPGRADING

Equipped with every multimedia device, the facility of 1000 sq.m is entirely dedicated to lectures and to the spreading of new therapeutic techniques. Training course, live demonstrations and cultural events are being held for either Italian or foreign specialists.

COMPETENCE AND RELIABILITY

The Leone dealers worldwide are under constant professional improvement thanks to the technical assistance received by engineers and technical experts at Leone to get specific information on the products and solve any eventual problems from the customers.



LEONE IMPLANT SYSTEM



PRODUCT CATALOGUE

6..50

ALPHABETICAL INDEX

122-123



SURGICAL PROCEDURE

DISCLAIMER AND TREATMENT PLANNING

52-53

IMPLANT PACKAGING

54



LEONE IMPLANTS Ø 3,3, Ø 4,1 AND Ø 4,8:

- 1. preparation of the implant site 55..57
- 2. placement of the implant 58..60



LEONE 6.5 SHORT IMPLANT:

- 3. preparation of the implant site 61-62
- 4. placement of the implant 63-64

TWO-STAGE SURGICAL PROCEDURE:

- 5. first stage 65
- 6. second stage 66

CONDITIONING OF THE SOFT TISSUES:

- 7. for standard and large platform 66-67
- 8. for slim platform 67-68

ONE-STAGE SURGICAL PROCEDURE:

- 9. for standard and large platform 68-69

LOW SELF-LOCKING CAP:

- 10. instructions for use and procedure 70-71

OVERDENTURE:

- 11. two-stage surgical procedure for standard platform 71-72



LEONE MAX STABILITY IMPLANTS Ø 3,75 AND Ø 4,5:

- selection of the Max Stability implant 73
- 1. preparation of the implant site 74..77
- 2. placement of the implant 78..80

MULTIMEDIA

In the following pages you can find QR codes storing multimedia contents of the LEONE Implant System which can be downloaded directly on your smartphone and through the online version of our product catalogue. You can download free QR reader applications (e.g. www.i-nigma.com). Videos are also available on our web-site: www.leone.it/english/implantology/qr-code/

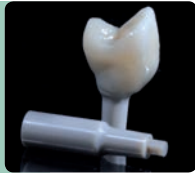

PROSTHETIC PROCEDURE

DISCLAIMER AND PREMISE

82

INDIRECT TECHNIQUE:

- | | |
|--|--------|
| 1. impression taking | 83 |
| 2. preparation of the dental cast | 84-85 |
| 3. preparation of the abutment | 85..87 |
| 4. selection, use and positioning of LEONE 360° anatomical abutments | 87..89 |
| 5. final positioning for standard and large platform | 90-91 |
| 6. final positioning for slim platform | 91 |

DIRECT TECHNIQUE:

- | | |
|--|-------|
| 7. positioning and preparation of the abutment,
impression taking for standard and large platform | 92-93 |
|--|-------|

OTHER PROSTHETIC SOLUTIONS:

- | | |
|---|----------|
| 8. ball head abutments for overdenture | 93..97 |
| 9. bar-retained overdenture and screw-retained prosthesis | 98..102 |
| 10. MultiTech abutments: directions for use | 103-104 |
| 11. intraoral scanning and use of Ti-Base abutments (CAD-CAM solutions) | 105 |
| 12. temporary abutments: application procedure | 106..108 |

Instructions for the removal of LEONE abutments	109-110
---	---------



LEONE MONOIMPLANTS FOR OVERDENTURE O-RING



SURGICAL AND PROSTHETIC PROCEDURE

DISCLAIMER AND TREATMENT PLANNING

112-113

- | | |
|--|---------|
| 1. Preparation of the implant site | 114-115 |
| 2. Monoimplant packaging | 116 |
| 3. Insertion of the monoimplant | 117-118 |
| 4. Preparation of the removable prosthesis | 119-120 |

Photos courtesy of:

- Dr. Salvatore Belcastro, Gubbio, Perugia, Italy
- Dr. Irene Frezzato and Dr. Alberto Frezzato, Rovigo, Italy
- Dr. Roberto Meli, Firenze, Italy

- Mr. Massimiliano Pisa, Firenze, Italy
- Dr. Leonardo Targetti, Firenze, Italy
- Dr. Renato Turrini, Lucca, Italy

LEONE DENTAL IMPLANT SYSTEM

The **LEONE** implant system offers a wide range of products that allows to choose the most adequate solution for the planned rehabilitation depending on the clinical situation and the prosthetic requirements.

The distinctive feature of the system is the **LEONE** implant-abutment connection, a combination of two geometries: self-locking Morse taper and internal hexagon.

The Morse taper ensures a remarkable mechanical stability, total absence of micro movements, a perfect bacterial seal and optimal distribution of masticatory loading. The hexagon enhances the resistance to torsional loading and guarantees the precise transfer of the angular position of the abutment between the dental office and the laboratory.

The **LEONE** Implant System is characterized by Platform Switching as a natural consequence of the taper connection.

Regarding the implant macro-design, the **LEONE** implant system includes three different types of fixtures: the **LEONE** implants, featuring a cylindrical geometry, with a thread design in accordance with ISO standard and a hemispherical apex; the **Max Stability** implants, having a root-form geometry, a more aggressive thread design and a conical apex, suitable for poor bone density and fresh extraction sockets; the **LEONE 6.5** short implant, with a minimised length, a thread with an even increased height and a flat apex, ideal for cases with limited vertical bone availability.

All **LEONE** implants are manufactured from medical grade 5 titanium and feature the **HRS** (High Rutile Surface) surface, obtained through an exclusive sandblasting process which produces a roughness $R_a = 2.5 \mu\text{m}$ on the implant, favouring the activity of osteoblasts and ensuring a rapid osseointegration.

Due to the Morse taper implant-abutment connection, the **LEONE** abutments do not need a retaining screw, they are solid, with no cavities. This feature, combined with the particular quality of the titanium used, allows the abutment to be easily customized either in the laboratory or directly in the oral cavity of the patient.

A colour code is associated with each implant diameter and helps the user choose the relevant accessories and necessary tools for the following work phases.



LASER MARKED
to guarantee
the original product

HRS surface

KEY TO DENTAL IMPLANTS



For implant:
Ø 3,3 mm



For implant:
Ø 4,1 mm



For implant:
Ø 4,8 mm



For implant:
Max Stability Ø 3,75 mm



For implant:
Max Stability Ø 4,5 mm



For implant:
short 6.5



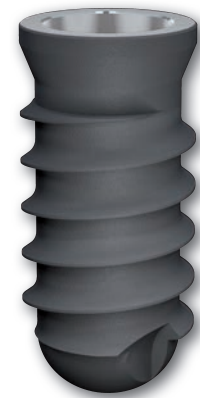

LEONE IMPLANTS

Made of medical grade 5 titanium, cylindrical screw shaped. **HRS** surface and **LEONE** connection. Mounted on a carrier, with an included biopolymer sealing cover cap, and packed in gamma-ray sterile glass vial. Cap removal from the inner holder and placement into the implant requires instrument Cat. 156-1003-00.





Pack content: 1 implant and 1 cover cap







LEONE IMPLANT Ø 3.3 mm with cover cap

				
Ø 3,3 mm				
length	8 mm	10 mm	12 mm	14 mm
	110-3308-02	110-3310-02	110-3312-02	110-3314-02

LEONE IMPLANT Ø 4.1 mm with cover cap

				
Ø 4,1 mm				
length	8 mm	10 mm	12 mm	14 mm
	110-4108-02	110-4110-02	110-4112-02	110-4114-02

LEONE IMPLANT Ø 4.8 mm with cover cap

				
Ø 4,8 mm				
length	8 mm	10 mm	12 mm	14 mm
	110-4808-02	110-4810-02	110-4812-02	110-4814-02



TOP LID



SEALING CAP



CARRIER

IMPLANT

INNER HOLDER

COVER CAP



GLASS VIAL

LEONE 6.5 SHORT IMPLANT



- Ideal for cases with limited vertical bone availability
- To avoid complex bone grafting procedures
- To minimize advanced surgical interventions (sinus lift, inferior alveolar nerve transposition)
- To avoid sensitive anatomical structures with a high degree of safety
- To increase patient's acceptance due to reduced treatment time and costs



LEONE 6.5 SHORT IMPLANT with cover cap

Made of medical grade 5 titanium, cylindrical screw shaped. **HRS** surface and **LEONE** connection. Mounted on a carrier, with an included biopolymer sealing cover cap, and packed in gamma-ray sterile glass vial. Cap removal from the inner holder and placement into the implant requires instrument Cat. 156-1003-00.

Pack content: 1 implant and 1 cover cap

	
Ø 5 mm	
length	6,5 mm
110-5065-02	

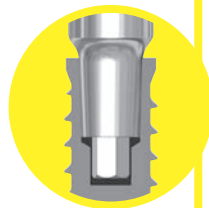

The cover cap supplied with the implant is yellow since **it has the same internal connection as the standard 4,1 mm-diameter LEONE implant**. This ensures absolute stability and mechanical resistance: extremely important issues in this particular case as the crown-implant ratio results to be increased. There is no need for special accessories: healing caps, transfers and abutments for the 4.1 mm connection with yellow colour code are to be used.

- **LENGTH** reduced to 6.5 mm
- **INCREMENTAL THREADS** with diameter up to 5 mm
- **FLAT APEX** for additional decrease of the implant's length
- **IMPLANT THREAD** in comparison to **LEONE** standard implants the height of the implant thread is increased by 125%, the bone contact surface is comparable to the surface of an implant 4,1 mm in diameter and 8 mm long.

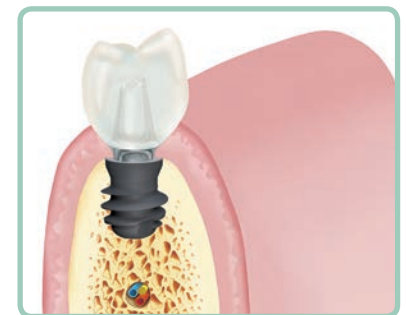

The **LEONE 6.5** short implant and the whole range of specific surgical instruments are featured by a **FUCHSIA COLOUR-CODE**.

LEONE MAX STABILITY IMPLANTS

Max Stability implants feature an innovative external macro-design, formulated to obtain a high primary stability in cases where the implant site offers poor stability for fixtures with a classical design. The implant primary stability is evaluated by measuring the insertion torque values. In medium to poor bone quality they have over 50% higher insertion torque values compared to cylindrical implants with the same length and connection size.

Max Stability implants $\varnothing 3,75$ and $\varnothing 4,5$ mm have the same internal connection as the $\varnothing 3,3$ and $\varnothing 4,1$ mm implants. The surgical procedure for the preparation of the implant site is also the same. Accordingly, the colour codes are also identical: GREEN for the $\varnothing 3,75$ implants - YELLOW for the $\varnothing 4,5$ implants.





Made of medical grade 5 titanium. HRS surface and LEONE connection. Mounted on a carrier, with an included biopolymer sealing cover cap, and packed in gamma-ray sterile glass vial. Cap removal from the inner holder and placement into the implant requires instrument Cat. 156-1003-00.

Pack content: 1 implant and 1 cover cap

MAX
STABILITY







LEONE MAX STABILITY IMPLANT $\varnothing 3,75$ mm with cover cap

				
$\varnothing 3,75$ mm				
length	8 mm	10 mm	12 mm	14 mm
	110-3808-02	110-3810-02	110-3812-02	110-3814-02



The cover cap supplied with the implant is green since it has the same internal connection as the standard 3.3 mm-diameter LEONE implant. Healing caps, transfers, and abutments for the 3.3 mm connection with green colour code are to be used.

LEONE MAX STABILITY IMPLANT $\varnothing 4,5$ mm with cover cap

				
$\varnothing 4,5$ mm				
length	8 mm	10 mm	12 mm	14 mm
	110-4508-02	110-4510-02	110-4512-02	110-4514-02

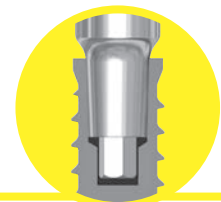

The cover cap supplied with the implant is yellow since it has the same internal connection as the standard 4.1 mm-diameter LEONE implant. Healing caps, transfers, and abutments for the 4.1 mm connection with yellow colour code are to be used.

- **ROOT-FORM**
with conical apex facilitating the insertion process
- **INCREMENTAL APICAL THREADS**
with increasing height
- **THREAD DESIGN**
results in an over a 50% increase in thread height compared to cylindrical implants, leading to a considerable increase in primary stability as well as a gain in bone-implant contact surface area compared to cylindrical implants with the same length and connection size

WHEN TO USE A LEONE MAX STABILITY IMPLANT

- ▶ **In case of implant placement with poor bone quality**
The thread design and the apex profile allow good anchorage, even in the presence of reduced bone density.
- NOT FOR INSERTION IN D1 BONE**
- ▶ **In case of implant placement into fresh extraction sockets**
The geometry of the implant is ideal for the insertion in post-extraction sockets.
- ▶ **In case of some advanced surgical interventions**
The implant apex, featuring a conical profile and incremental threads, facilitates the insertion process by reducing the risk of fractures and fenestrations.

PLATFORM SWITCHING

The emergence profile of the **LEONE** abutments features a smaller diameter than the maximum diameter of the implant neck. The “Platform Switching” concept involves several advantages like the shift of the area of the inflammatory infiltrate inwards (away from the crestal bone), a reduced perimeter to protect against the external agents, a larger amount of periimplant gingival soft tissue and therefore a better mucosa seal to protect the crestal bone.

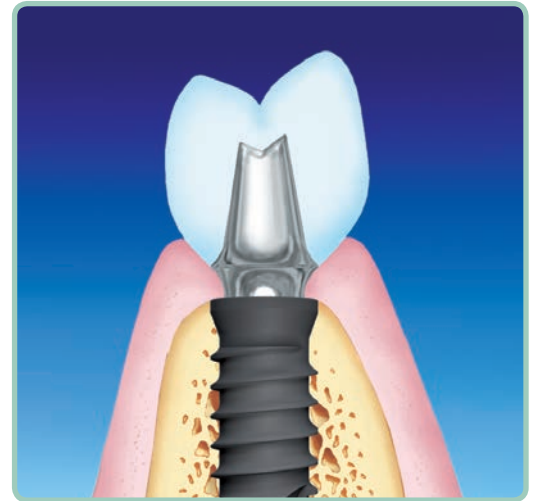

THE MEANING OF PROSTHETIC PLATFORM

After the placement of the implant, thanks to the Platform Switching concept, the **LEONE** Implant System offers the possibility to select the diameter of the most appropriate abutment to the clinical situation. Specific healing caps and transfer are available for each platform that allow the achievement of excellent results in the conditioning of the soft tissues and impression taking.

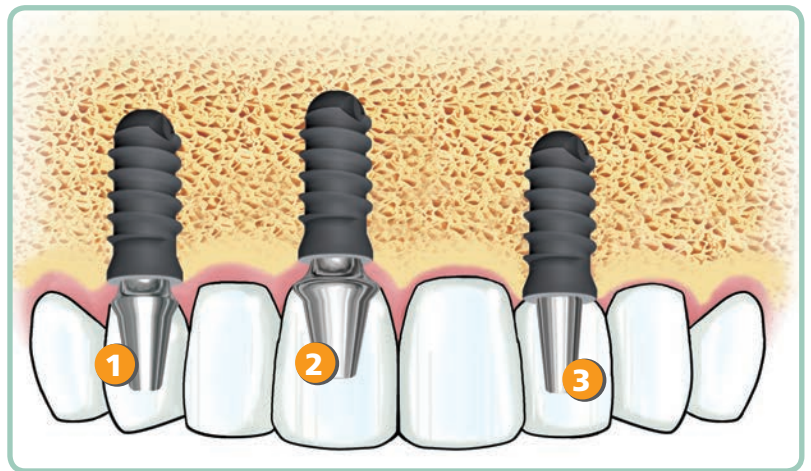

STANDARD PLATFORM

The diameter is the **SAME** as the diameter of the implant neck. Indicated for standard treatments. Featured by Platform Switching.

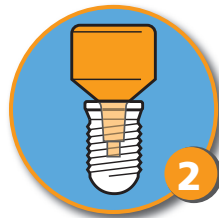

LARGE PLATFORM

The diameter is **LARGER** than the diameter of the implant neck. Indicated when the tooth to be replaced is noticeably larger in comparison to the inserted implant. The aim is to enhance functionality and aesthetics. Featured by Platform Switching.



SLIM PLATFORM

The diameter is **SMALLER** than the diameter of the implant neck. Indicated in aesthetic areas with low gingival thickness. It allows the manufacture of a crown closing on the implant neck.

KEY TO PROSTHETIC PRODUCTS

Since the following groups of implants have the same implant-abutment connection size, the colour code for the choice of the prosthetic products is the following:



for implants:
 \varnothing 3,3 mm
 Max Stability \varnothing 3,75 mm







for implants:
 \varnothing 4,1 mm
 Max Stability \varnothing 4,5 mm
 short 6.5



for implants:
 \varnothing 4,8 mm





SELF-LOCKING CAPS, LOW





Made of medical grade 5 titanium.
 Single supplied on carrier and packed in gamma-ray sterilized glass vials. The caps are locked into the implant through the application of an impulsive force that activates the locking-taper connection. They are used in place of the cover caps in cases of subcrestal implant placement or in place of the healing caps in cases of low gingival thickness (pages 70, 71). Use the special hex head extractor Cat. 156-1006-00 to unlock the connection. Use the instrument for cover cap Cat. 156-1003-00 for removal.
 Pack of 1





			
for implant			
Ø platform	3,3 mm	4,1 mm	4,8 mm
gingival height	1,5 mm	1,5 mm	1,5 mm
	133-3301-33	133-4101-41	133-4801-48

STANDARD HEALING CAPS

Made of medical grade 5 titanium.
 Single supplied ready on carrier, packed in gamma-ray sterile glass vial. Healing caps are locked in the implants by means of an impulsive force which activates the locking-taper connection. Use the special hex head extractor Cat. 156-1006-00 to unlock the connection.
 Pack of 1





			
for implant			
Ø platform	3,3 mm	3,3 mm	3,3 mm
gingival height	3 mm	5 mm	7 mm
	131-3303-33	131-3305-33	131-3307-33

			
for implant			
Ø platform	4,1 mm	4,1 mm	4,1 mm
gingival height	3 mm	5 mm	7 mm
	131-4103-41	131-4105-41	131-4107-41

			
for implant			
Ø platform	4,8 mm	4,8 mm	4,8 mm
gingival height	3 mm	5 mm	7 mm
	131-4803-48	131-4805-48	131-4807-48

STANDARD TRANSFERS

Made of stainless steel.
 They are used for taking and sending the impression to the laboratory to reproduce the exact position of the implant on the dental cast.
 Pack of 1

			
for implant			
Ø platform	3,3 mm	4,1 mm	4,8 mm
gingival height	5 mm	5 mm	5 mm
	141-3305-33	141-4105-41	141-4805-48



TEMPORARY ABUTMENTS

The **LEONE** temporary abutments are used for provisional restorations (they have the emergence profile of the Standard platform). They are connected to the implants in the same way as the titanium abutments, using the same instruments. The Morse taper connection guarantees a suitable tightness for use over a limited period of time allowing an easy removal of the abutment whenever advisable. Made of a special ultra-polymer - a PEEK polymer featuring very high mechanical properties - highly biocompatible, easily preparable and radiotransparent. They are seated into the implants through the **LEONE** connection. Sterilizable in autoclave.

Pack of 1

for implant			
height	10 mm	10 mm	10 mm
STRAIGHT	161-3310-00	161-4110-00	161-4810-00
15° ANGLED	161-3310-15	161-4110-15	161-4810-15

STANDARD ABUTMENTS

Made of medical grade 5 titanium. The abutments are seated into the implants through the **LEONE** connection.

Pack of 1

CYLINDER ABUTMENTS

for implant			
Ø platform	3,3 mm	4,1 mm	4,8 mm
height	10 mm	10 mm	10 mm
	120-3310-33	120-4110-41	120-4810-48

15° PRE-INCLINED ABUTMENTS

for implant			
Ø platform	3,3 mm	4,1 mm	4,8 mm
height	10 mm	10 mm	10 mm
	124-3303-01	124-4103-01	124-4803-01

25° PRE-INCLINED ABUTMENTS

for implant			
Ø platform	3,3 mm	4,1 mm	4,8 mm
height	10 mm	10 mm	10 mm
	124-3303-02	124-4103-02	124-4803-02

25° ANGLED ABUTMENTS

for implant			
Ø platform	3,3 mm	4,1 mm	4,8 mm
height	10 mm	10 mm	10 mm
	125-3303-33	125-4103-41	125-4803-48



A try-in abutment in plastic material is available associated with each abutment herewith indicated (page 28)



LEONE 360° ANATOMICAL ABUTMENTS

LEONE 360° anatomical abutments have got the ideal features to facilitate the prosthetic procedure during the customizing phase in the laboratory and the clinical procedures afterwards.

The main innovation of this product, **protected by an international patent**, is the apical hexagon separated from the rest of the abutment: the free positioning to 360° on the dental cast makes it easy to achieve parallelism while taking advantage of the anatomical form of the abutments. Afterwards, through the activation of the self-locking conical connection, the abutment will join the hexagon directed in the selected position which will drive the clinician in the positioning on the patient with the maximum precision (pages 87..89).

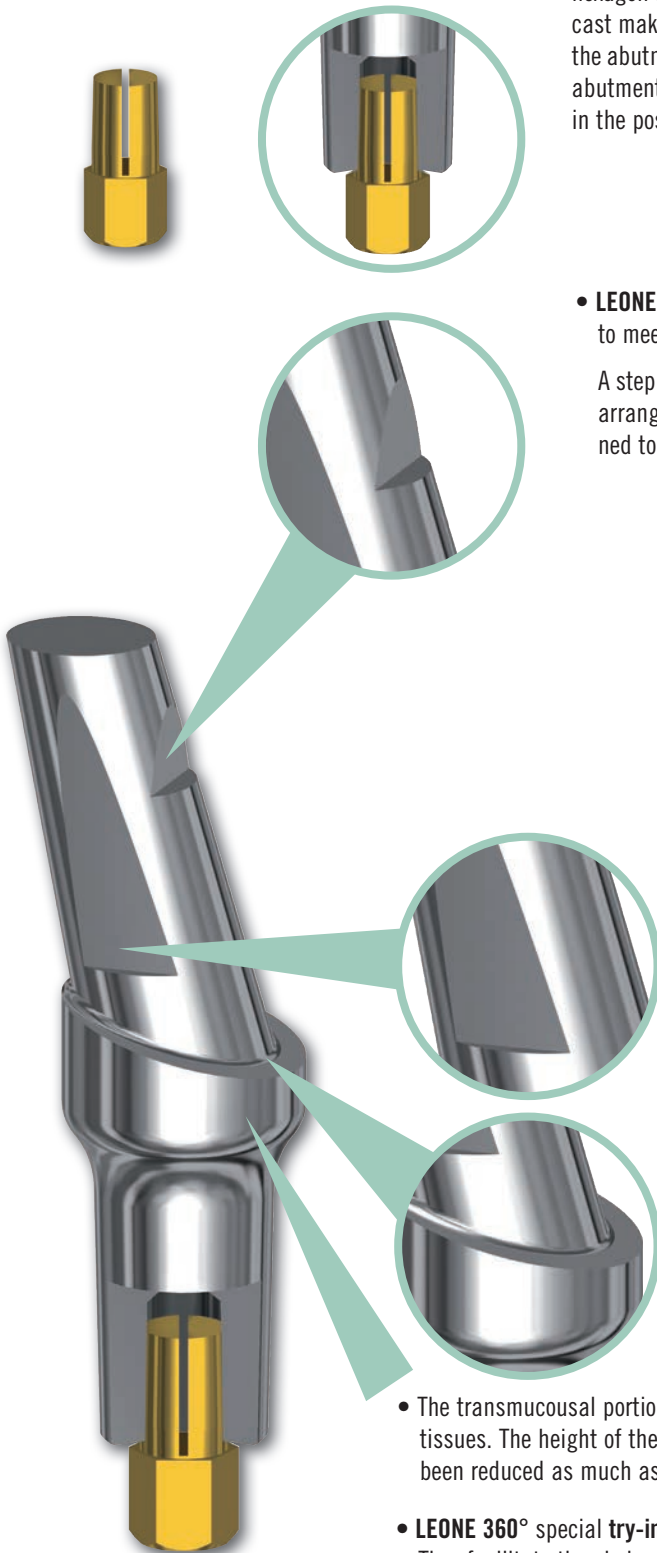

- **LEONE 360°** anatomical abutments are available either straight or angled at 15° or 25° to meet all demands for the prosthetic rehabilitation.

A step on the angled abutment allows the activation of the connection by exerting a force arranged coaxially to the implant axis. A special flat tip (Cat. 156-1008-06) may be joined to the multi-purpose handle or the abutment beater thus assuring a stable support.



- The morphologic shape of the abutment portion to be cemented features an optimal inclination and two opposite plain faces to improve the position and the retention of the copings.

- The preformed shoulder may be further customized. The angled anatomical abutments show the vestibular portion, the part with the higher aesthetical value, with a height lower than lingual.

- The transmucousal portion is available in four heights for a precise adaptation to the thickness of the soft tissues. The height of the platform switching of the **LEONE 360°** anatomical abutments **zero shoulder** has been reduced as much as possible for cases with low gingival thickness.

- **LEONE 360°** special **try-in abutments** are associated with this innovative product. They facilitate the choice of the most appropriate abutment in the laboratory thus avoiding the necessity of goods storage and the possibilities of mistake. The **try-in abutments** are manufactured from a plastic material, autoclavable and may also be used to test the transmucousal portion on the patient.



Leone 360° anatomical abutments

LEONE 360° ANATOMICAL ABUTMENTS

Made of medical grade 5 titanium. They are seated into the implants through the **LEONE 360°** connection.
Pack of 1 abutment and 1 hexagon

for implant					
abutment shoulder minimum height	0 mm	1 mm	2 mm	3 mm	
STRAIGHT	129-3300-03	129-3301-00	129-3302-00	129-3303-00	
15° ANGLED	129-3300-01	129-3301-01	129-3302-01	129-3303-01	
25° ANGLED	129-3300-02	129-3301-02	129-3302-02	129-3303-02	

for implant					
abutment shoulder minimum height	0 mm	1 mm	2 mm	3 mm	
STRAIGHT	129-4100-03	129-4101-00	129-4102-00	129-4103-00	
15° ANGLED	129-4100-01	129-4101-01	129-4102-01	129-4103-01	
25° ANGLED	129-4100-02	129-4101-02	129-4102-02	129-4103-02	

for implant					
abutment shoulder minimum height	1 mm		2 mm		3 mm
STRAIGHT	129-4801-00		129-4802-00		129-4803-00
15° ANGLED	129-4801-01		129-4802-01		129-4803-01
25° ANGLED	129-4801-02		129-4802-02		129-4803-02

HEXAGON FOR LEONE 360° ABUTMENTS

Made of medical grade 5 titanium.
Pack of 2

for implant			
	129-3300-00	129-4100-00	129-4800-00



A try-in abutment in plastic material is available associated with each abutment herewith indicated (page 15)



160-0001-03

new

TRY-IN KIT FOR LEONE 360° ANATOMICAL ABUTMENTS

Manufactured from plastic material, autoclavable, in three colour-codes: green, yellow and red, to allow the immediate identification of the corresponding implant diameter.

They are the exact replica of the **LEONE 360°** anatomical abutments but without the apical hexagon to test the most appropriate position for each specific case.

Each try-in abutment is marked with a number useful for the placement in the proper space into the kit. A transparent template over the plastic case, shows the outlines and the catalogue code numbers of each corresponding titanium anatomical abutment to facilitate the ordering of the selected type.

4 plastic try-in abutments for each type are contained in the kit to allow the choice in complex prosthetic rehabilitations. Only the inner tray is autoclavable.

Kit content:

4 try-in abutments each implant diameter and each shape: straight, angled at 15° and 25° and each shoulder height available (page 14), total 132 pcs



160-0033-03

new

REFILL - LEONE 360° ANATOMICAL TRY-IN ABUTMENTS FOR IMPLANTS 3,3 AND MAX STABILITY 3,75

Content:

4 sets of try-in abutments for implant 3.3 and **Max Stability** 3,75, each type: straight, angled at 15° and 25° and each shoulder height available, total 48 pcs

160-0041-03

new

REFILL - LEONE 360° ANATOMICAL TRY-IN ABUTMENTS FOR IMPLANTS 4,1, SHORT 6.5 AND MAX STABILITY 4,5

Content:

4 sets of try-in abutments for implant 4.1, **LEONE 6.5** short implant and **Max Stability** 4,5, each type: straight, angled at 15° and 25° and each shoulder height available, total 48 pcs

160-0048-01

REFILL - LEONE 360° ANATOMICAL TRY-IN ABUTMENTS FOR IMPLANTS 4,8



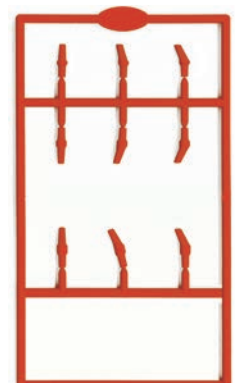
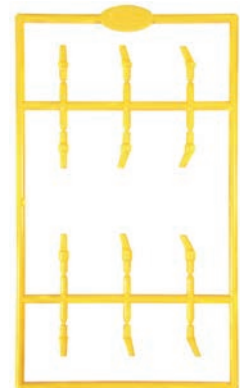
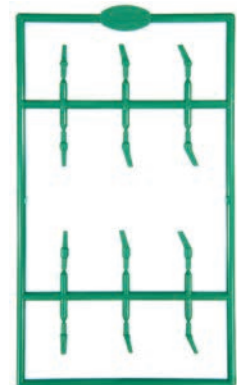

Content: 4 sets of try-in abutments for implant 4.8 each type: straight, angled at 15° and 25° and each shoulder height available, total 36 pcs













LARGE HEALING CAPS

Made of medical grade 5 titanium.
 Single supplied on carrier, packed in gamma-ray sterile glass vial.
 Healing caps are locked into the implants by means of an impulsive force which activates the locking-taper connection. Use the specific hex-head extractor Cat. 156-1006-00 to unlock the connection.
 Pack of 1





			
for implant			
Ø platform	4,5 mm	4,5 mm	4,5 mm
gingival height	3 mm	5 mm	7 mm
	131-3303-45	131-3305-45	131-3307-45

			
for implant			
Ø platform	5,5 mm	5,5 mm	5,5 mm
gingival height	3 mm	5 mm	7 mm
	131-4103-55	131-4105-55	131-4107-55

			
for implant			
Ø platform	6,0 mm	6,0 mm	6,0 mm
gingival height	3 mm	5 mm	7 mm
	131-4803-60	131-4805-60	131-4807-60

LARGE TRANSFERS

Made of stainless steel.
 They are used for taking and sending the impression to the laboratory to reproduce the exact position of the implant on the dental cast.
 Pack of 1





			
for implant			
Ø platform	4,5 mm	5,5 mm	6,0 mm
gingival height	5 mm	5 mm	5 mm
	141-3305-45	141-4105-55	141-4805-60



LARGE ABUTMENTS

Made of medical grade 5 titanium.
They are seated into the implants through the **LEONE** connection.
Pack of 1

CYLINDER ABUTMENTS

			
for implant			
Ø platform	4,5 mm	5,5 mm	6,0 mm
height	10 mm	10 mm	10 mm
	120-3310-45	120-4110-55	120-4810-60



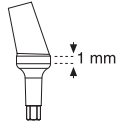
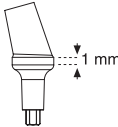
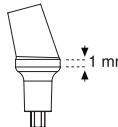

15° PRE-INCLINED ABUTMENTS

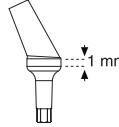
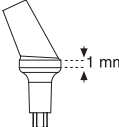
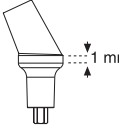
	 1 mm	 1 mm	 1 mm
for implant			
Ø platform	4,5 mm	5,5 mm	6 mm
height	10 mm	10 mm	10 mm
	124-3303-03	124-4103-03	124-4803-03

25° PRE-INCLINED ABUTMENTS

	 1 mm	 1 mm	 1 mm
for implant			
Ø platform	4,5 mm	5,5 mm	6 mm
height	10 mm	10 mm	10 mm
	124-3303-04	124-4103-04	124-4803-04

25° ANGLED ABUTMENTS

			
for implant			
Ø platform	4,5 mm	5,5 mm	6,0 mm
height	10 mm	10 mm	10 mm
	125-3303-45	125-4103-55	125-4803-60



A try-in abutment in plastic material is available associated with each abutment herewith indicated (page 28)



SLIM HEALING CAPS

Made of medical grade 5 titanium.
 Single supplied on carrier, packed in gamma-ray sterile glass vial.
 Healing caps are locked into the implants by means of a pressure exerted on the cap once the internal hexagon is correctly engaged.
 Use instrument Cat. 156-1003-00 for removal of the caps.
 Pack of 1

for implant			
transmucosal Ø	3,3 mm	4,1 mm	4,8 mm
gingival height	3 mm	3 mm	3 mm
	132-3303-33	132-4103-41	132-4803-48

SLIM TRANSFERS

Made of stainless steel.
 They are used for taking and sending the impression to the laboratory to duplicate the exact position of the implant on the dental cast.
 Pack of 1

for implant			
transmucosal Ø	3,3 mm	4,1 mm	4,8 mm
gingival height	3 mm	3 mm	3 mm
	143-3303-33	143-4103-41	143-4803-48

SLIM ABUTMENTS

Made of medical grade 5 titanium. The abutments are seated into the implants through the **LEONE** connection.
 Pack of 1

CYLINDER ABUTMENTS

for implant			
transmucosal Ø	2,2 mm	3,0 mm	3,7 mm
height	10 mm	10 mm	10 mm
	120-3310-22	120-4110-30	120-4810-37

10° ANGLED DOUBLE ABUTMENTS

for implant			
transmucosal Ø	2,2 mm	3,0 mm	3,7 mm
height	10 mm	10 mm	10 mm
	127-3301-10	127-4101-10	127-4801-10

MULTITECH ABUTMENTS

MultiTech abutments are used to fabricate a fully patient-customized abutment through the creation of a customized part to be bonded on the central portion of the abutment. Recommended bonding materials: NIMETIC CEM (3M Espe), MULTILINK HYBRID ABUTMENT (Ivoclar Vivadent).

The customized abutment portion can be performed as follows (pages 103-104):

- **with CAD-CAM technology** by taking a scan of the seated abutment on the dental cast and modelling of the customized abutment portion with a specific software. The fabrication is performed in the laboratory with a specific Computer-Assisted Machine or by a specialized production centre upon the receipt of the data file;
- **with the traditional method** by using a pre-fabricated burn-out coping placed on the abutment, adjustment and modelling with wax and/or acrylic and fabrication of the customized abutment portion through casting.

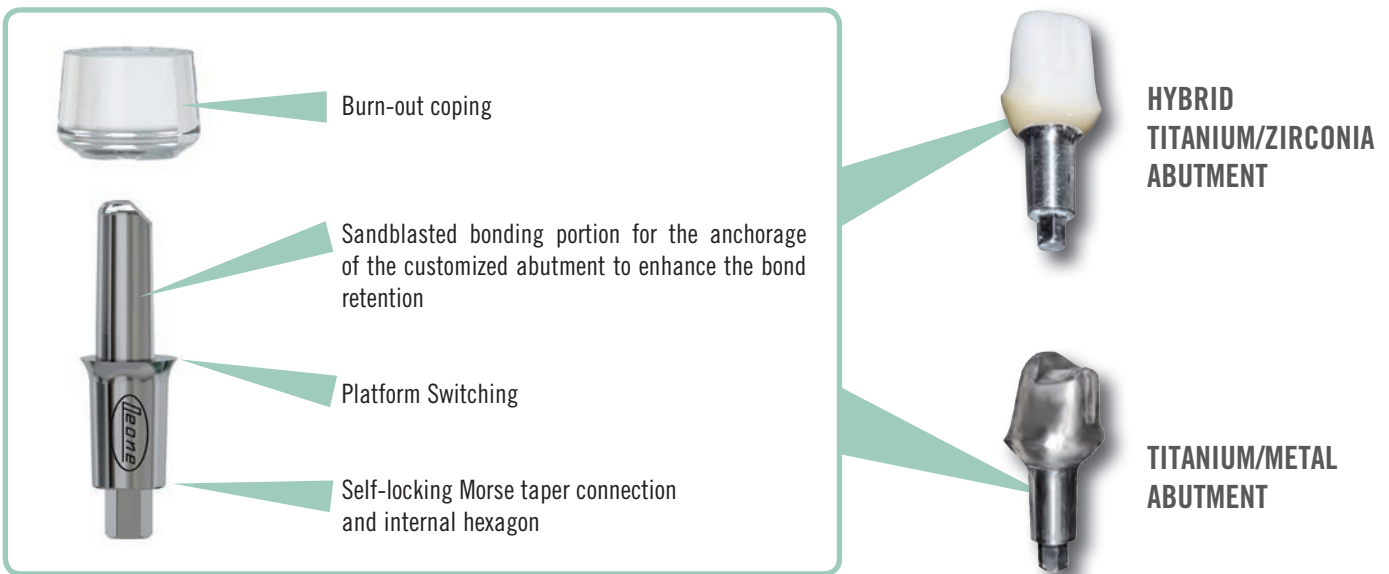

new

MULTITECH ABUTMENTS

Made of medical grade 5 titanium, they are seated into the implants through the **LEONE** connection (straight abutments) or through the **LEONE 360°** connection (angled abutments). Also available 15° angled to help achieve parallelism. The bonding portion of the abutment is entirely sandblasted. Pack content: 1 abutment, 1 hexagon (for the angled abutments only), 2 burn-out copings

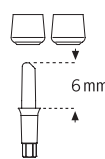
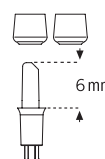
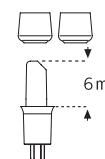
			
for implant			
bonding portion	6 mm	6 mm	6 mm
STRAIGHT	121-3306-00	121-4106-00	121-4806-00

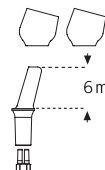
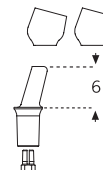
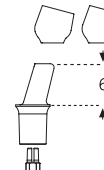
			
for implant			
bonding portion	6 mm	6 mm	6 mm
15° ANGLED	121-3306-15	121-4106-15	121-4806-15



TI-BASE ABUTMENTS

The Ti-Base abutment allows the fabrication of a fully patient-customized abutment through the creation of a customized part to be bonded on the bonding portion. It has been developed for a completely digital workflow, from impression taking to CAD-CAM fabrication of the restoration. Its geometry allows the use of specific blocks for a rapid and precise CAM milling of the customized portion. Recommended bonding materials: NIMETIC CEM (3M Espe), MULTILINK HYBRID ABUTMENT (Ivoclar Vivadent).

Made of medical grade 5 titanium, they are seated into the implants through the **LEONE** connection.

Pack of 1

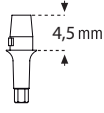
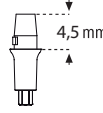
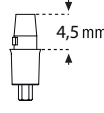
			
for implant			
bonding portion	4,5 mm	4,5 mm	4,5 mm
	121-3305-51	121-4105-51	121-4805-51



SCAN POST AND SCAN BODY

The scan post coupled with the scan body permit precise acquisition of the implant position through a digital impression taking procedure chairside in the mouth or by digitization of the dental cast. The digital acquisition allows CAD planning and the use of the Ti-Base abutment during the following prosthetic steps.

The scan post, made of stainless steel, is connected to the implant through the transfer-like split hex connection. The scan body, a plastic cap to be mounted on the scan post, has a specific geometry for digital capture by means of a dedicated software. The scan body is available in two colours, white and grey, to optimize acquisition depending on the intraoral scanner type.

Pack content: 1 scan post, 3 white scan bodies, 3 grey scan bodies

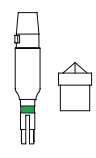
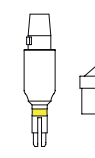
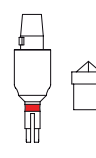
			
for implant			
transmucosal Ø	3,3 mm	4,1 mm	4,8 mm
gingival height	6 mm	6 mm	5 mm
	141-3313-51	141-4113-51	141-4813-51

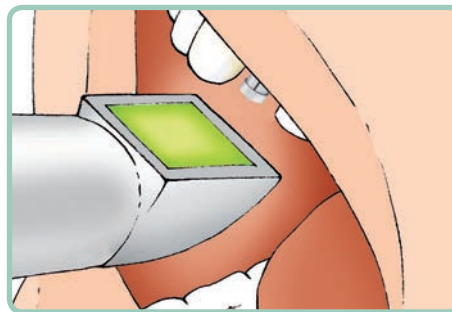

141-0000-51 REFILL - PLASTIC SCAN BODIES

Content: 5 white scan bodies, 5 grey scan bodies



SCAN POST POSITIONER

Made of stainless steel. It is used to place the scan post into the implant. With a hole for the placement of a safety leash.

Pack of 1



The continuous and rapid evolution of digital technology implies a constant updating of the procedures as well as of the associated components. Please refer to the online catalogue for the relevant updates.







new BALL HEAD ABUTMENTS FOR OVERDENTURE

The ball head abutments for overdenture represent an evolution of the O-ring overdenture abutment product line. The abutments feature a perfectly ball-shaped head with a titanium nitride coating to increase its wear resistance. The angled abutments are characterized by the **LEONE 360°** connection, protected by an international patent, having an apical hexagon separated from the rest of the abutment. The free positioning to 360° of the abutment on the dental cast makes it easy to achieve parallelism, whereas the permanent connection of the hexagon in the selected position allows an accurate placement of the abutment in the mouth. The ball head abutments for overdenture are available with the Standard prosthetic platform only for 3,3 mm and 3,75 mm implants (green connection size) and for 4,1 mm, 4,5 mm and **LEONE 6.5** implants (yellow connection size), in straight and 15° angled version, in 3 different gingival heights, 1,5 – 3 – 5 mm.

In conjunction with these abutments, elastomer retentive inserts with ball anchorage in different types of rigidity have been developed to provide a method of stabilization for overdentures that is alternative to the traditional O-ring system.

The inserts are available in three different types of rigidity, identifiable by the following colour code: white (soft insert), orange (medium insert), violet (rigid insert).

		SOFT
		MEDIUM
		RIGID

The inserts are contained within specific metal housings: the housings are made of pink anodized titanium for better aesthetics within the removable denture; from a dimensional point of view they take up very little space, less than the micro housings with O-ring.

The retentive inserts are compatible with the abutments for O-ring overdenture which are available until stocks are exhausted; therefore they can also be used in conjunction with them for already restored cases.

To complete components related to ball head abutments, spacer rings have been developed, i.e. rings made of plastic material to place on the abutment when incorporating the housings into the removable denture, in order to obtain a supporting surface for the housings. In this way a correct degree of penetration of the housing on the ball head is ensured, holding it in place, along the head axis or with a preset angulation, preventing, in any case, unwanted inclinations.

When replacing the insert, remove the worn-out insert and press the new one into the housing by means of the specific instrument Cat. 156-1004-00.

The **LOW** spacer ring is used to incorporate the housing with O-ring or the micro housing with O-ring into the denture.

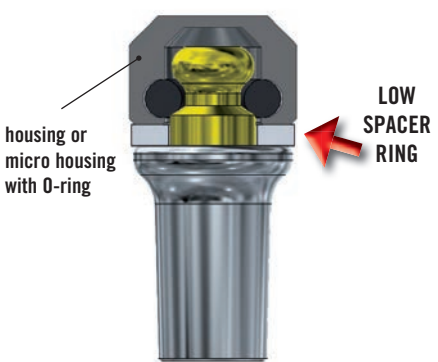

The **HIGH** spacer ring is used to incorporate the micro housing with insert into the denture along the head axis of the abutment.

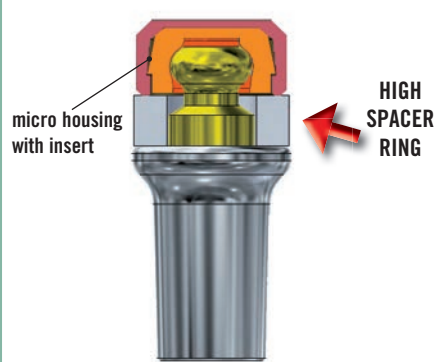

The **HIGH ANGLED** spacer ring, easily recognisable due to a protrusion at its maximum thickness, is used to incorporate the micro housing with insert into the denture with an angle increased by 10° in respect to the abutments head.

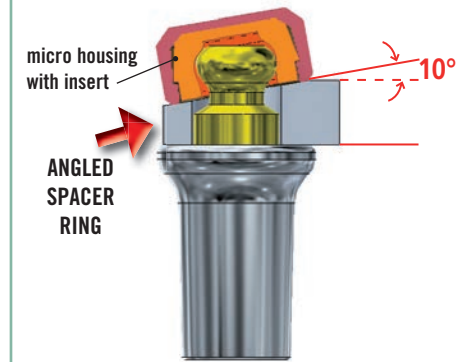





BALL HEAD ABUTMENTS FOR OVERDENTURE

Made of medical grade 5 titanium, they are seated into the implants through the **LEONE 360°** connection.

Pack content:

- 1 abutment,
- 1 hexagon (for the angled abutments only),
- 1 housing with O-Ring
- 1 micro housing with O-Ring,
- 1 micro housing with orange medium insert,
- 1 low spacer ring,
- 1 high spacer ring,
- 1 high angled spacer ring

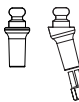
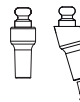
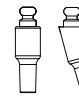
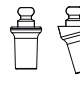
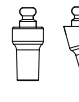
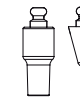
						
						
for implant						
gingival height	1,5 mm	3 mm	5 mm	1,5 mm	3 mm	5 mm
STRAIGHT	123-3300-01	123-3300-03	123-3300-05	123-4100-01	123-4100-03	123-4100-05
15° ANGLED	123-3315-01	123-3315-03	123-3315-05	123-4115-01	123-4115-03	123-4115-05



The abutments for O-ring overdenture listed in the previous edition of this catalogue are available until stocks are exhausted.

HOUSING WITH O-RING

Made of medical grade 5 titanium. Outer diameter: 5,4 mm, height: 3,1 mm.

Pack content:

- 1 housing with O-ring,
- 1 low spacer ring for abutments



[123-0002-00](#)

MICRO HOUSING WITH O-RING

Made of medical grade 5 titanium. Outer diameter: 4,2 mm, height: 2,8 mm.

Pack content:

- 1 micro housing with O-ring,
- 1 low spacer ring for abutments (grey),
- 1 spacer ring for monoimplants (white)



[123-0003-00](#)



A try-in abutment in plastic material is available associated with each abutment herewith indicated (page 28)

ELASTOMERIC O-RING

Pack of 2



123-0001-00

ELASTOMERIC MICRO O-RING

Pack of 2



123-0001-01

new

OVERDENTURE MICRO HOUSING WITH WHITE SOFT INSERT

Made of medical grade 5 titanium, outer diameter 4 mm, height 2 mm.

With pre-mounted white soft insert.

Pack content: 2 overdenture micro housings, 2 high spacer rings, 2 high angled spacer rings

123-0001-02

REFILL - WHITE SOFT MICRO INSERTS

Pack of 6

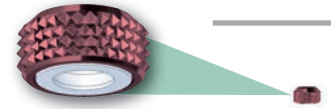

123-0004-02

new

OVERDENTURE MICRO HOUSING WITH ORANGE MEDIUM INSERT

Made of medical grade 5 titanium, outer diameter 4 mm, height 2 mm.

With pre-mounted orange medium insert.

Pack content: 2 overdenture micro housings, 2 high spacer rings, 2 high angled spacer rings

123-0001-03

REFILL - ORANGE MEDIUM MICRO INSERTS

Pack of 6

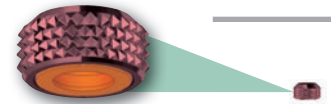

123-0004-03

new

OVERDENTURE MICRO HOUSING WITH VIOLET RIGID INSERT

Made of medical grade 5 titanium, outer diameter 4 mm, height 2 mm.

With pre-mounted violet rigid insert.

Pack content: 2 overdenture micro housings, 2 high spacer rings, 2 high angled spacer rings

123-0001-04

REFILL - VIOLET RIGID MICRO INSERTS

Pack of 6

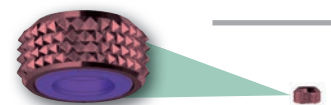

123-0004-04

new

OVERDENTURE INSERT SEATING TOOL

Made of stainless steel.

It is used to place the insert for overdenture inside its housing.



156-1004-00



STANDARD ABUTMENTS FOR SCREW-RETAINED PROSTHESIS

The abutments for screw-retained prosthesis have a tapered top with an internal thread allowing the connection of a prosthesis by screw retention. They are indicated for screw-retained prosthesis (hybrid prosthesis or screw-retained bridges) as well as for bar-retained overdentures.

The abutments for screw-retained prosthesis are available in straight versions as well as in 15°, 25° and 35° angled versions to help achieve parallelism for non-parallel implants.

The angled abutments are characterized by the **LEONE 360°** connection, protected by an international patent, having an apical hexagon separated from the rest of the abutment. The free positioning to 360° of the abutment on the dental cast makes it easy to achieve parallelism, whereas the permanent connection of the hexagon in the selected position allows an accurate positioning of the abutment in the mouth.

The package of all abutments for screw-retained prosthesis includes two different burn-out copings, a standard burn-out coping and a high burn-out coping. This simplifies the preparation of the definite metallic framework which can be obtained by a casting process using a metallic alloy at technician's option. In this way the dental casting phase with waxes at the abutment's interface is avoided ensuring a higher precision of the final restoration.

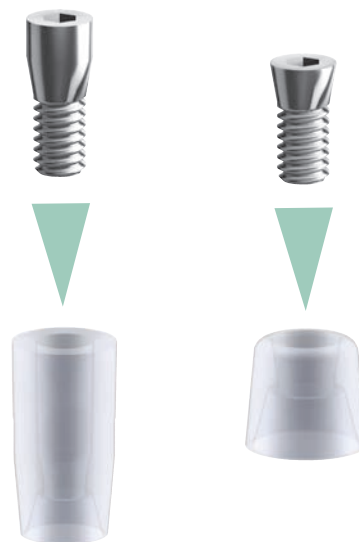

- **The standard burn-out coping (height: 4 mm)**
is designed for the realization of traditional bar-retained overdentures.
- **The high burn-out coping (height: 10 mm)**
is suitable for the realization of milled bars or screw-retained prosthesis. Its height can be cut back: a step on the external surface shows the shortening limit.
- **The standard connecting screw**
is designed for the standard burn-out coping.
- **The high head connecting screw**
is designed for the high burn-out coping or, in general, for high frameworks.



STANDARD ABUTMENTS FOR SCREW-RETAINED PROSTHESIS

Made of medical grade 5 titanium. They are seated into the implants through the **LEONE 360°** connection.

Pack content: 1 abutment, 1 hexagon (for the angled abutments only), 1 standard burn-out coping, 1 standard connecting screw, 1 high burn-out coping, 1 high head connecting screw

for implant							
gingival height	1,5 mm	3 mm	5 mm	7 mm			
STRAIGHT	126-3301-01	126-3303-01	126-3305-01	126-3307-01			
15° ANGLED	126-3301-15	126-3303-15	126-3305-15				
25° ANGLED	126-3301-25	126-3303-25	126-3305-25				
35° ANGLED		126-3303-35	126-3305-35				

for implant							
gingival height	1,5 mm	3 mm	5 mm	7 mm			
STRAIGHT	126-4101-01	126-4103-01	126-4105-01	126-4107-01			
15° ANGLED	126-4101-15	126-4103-15	126-4105-15				
25° ANGLED	126-4101-25	126-4103-25	126-4105-25				
35° ANGLED		126-4103-35	126-4105-35				

for implant							
gingival height	1,5 mm	3 mm	5 mm	7 mm			
STRAIGHT	126-4801-01	126-4803-01	126-4805-01	126-4807-01			
15° ANGLED		126-4803-15	126-4805-15				
25° ANGLED		126-4803-25	126-4805-25				



A try-in abutment in plastic material is available associated with each abutment herewith indicated (page 28)

STANDARD CONNECTING SCREW FOR SCREW-RETAINED PROSTHESIS

Made of medical grade 5 titanium. Diameter: 2 mm; length: 4,5 mm.
Pack of 1

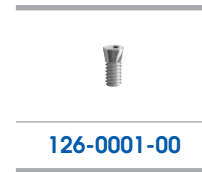

HIGH HEAD CONNECTING SCREW FOR SCREW-RETAINED PROSTHESIS

Made of medical grade 5 titanium. Diameter: 2 mm; length: 6 mm.
Pack of 1



ADAPTER FOR CONNECTING SCREW

Made of stainless steel. It is used joined to the large hand screwdriver Cat. 156-1001-01 to connect the bar or the screw-retained prosthesis to the abutment. Length: 15 mm.
Pack of 1





TRANSFERS FOR ABUTMENTS FOR SCREW-RETAINED PROSTHESIS

Made of stainless steel. They are used for impression taking on the abutments for screw-retained prosthesis already fixed to the implants to precisely reproduce the final position of the abutments on the dental cast.

TRANSFERS

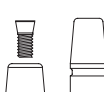

Pack content: 1 transfer, 1 protective cap, 1 standard connecting screw

			
for implant			
height	10 mm	10 mm	10 mm
	144-3310-00	144-4110-00	144-4810-00



PICK-UP TRANSFERS

Pack content: 1 pick-up transfer, 1 pick-up screw, 1 protective cap, 1 standard connecting screw

		
for implant		
height	8 mm	8 mm
	144-3308-01	144-4108-01



REFILL - SCREW FOR PICK-UP TRANSFER

Made of stainless steel. It is used together with the pick-up transfer for open-tray impression technique. Length: 12 mm.
Pack of 1





SHORT SCREWDRIVER FOR CONNECTING SCREW

Made of stainless steel. It is used to tighten pick-up or connecting screws. Length: 13 mm.
Pack of 1







TITANIUM COPINGS FOR ABUTMENTS FOR SCREW-RETAINED PROSTHESIS

Made of medical grade 5 titanium. They allow the fixing of provisional and definitive screw-retained prosthesis to the abutments. They are also used for intraoral and extraoral welding techniques. Height: 10 mm.
Pack of 2

			
for implant			
	126-0010-33	126-0010-41	126-0010-48

ANALOGS FOR ABUTMENTS FOR SCREW-RETAINED PROSTHESIS

Made of stainless steel, colour-coded for easy identification. They are used in the dental cast to precisely reproduce the final position of the abutments for screw-retained prosthesis.
Pack of 1

			
for implant			
length	15 mm	15 mm	15 mm
STRAIGHT	146-3315-00	146-4115-00	146-4815-00
15° ANGLED	146-3315-15	146-4115-15	146-4815-15

LONG WAXING SCREW

Made of stainless steel. During wax modelling on the abutment for screw-retained prosthesis, it allows the preparation of a channel of adequate dimensions for the seating of the connecting screw.
Length: 20 mm
Pack of 5







156-0015-00 ORGANIZER WITH BURS FG FOR ABUTMENTS

Kit content:
2 burs FG tungsten short tip Ø 1.2 mm Cat. 153-1221-02
2 burs FG tungsten long tip Ø 1.2 mm Cat. 153-1235-02
2 burs FG diamond-cut Ø 1.6 mm Cat. 153-1610-01
2 burs FG diamond-cut Ø 1.8 mm Cat. 153-1810-01



BURS FG FOR ABUTMENTS

They are used in combination with a turbine for milling the abutments in the mouth.
Pack of 1

BUR FG TUNGSTEN		BUR FG DIAMOND-CUT	
short tip	long tip		
			
Ø 1,2	Ø 1,2	Ø 1,6	Ø 1,8
153-1221-02	153-1235-02	153-1610-01	153-1810-01

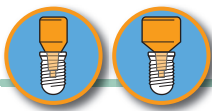

try-in abutments

160-0001-04 **new** TRY-IN KIT FOR STANDARD AND LARGE ABUTMENTS

Manufactured from plastic material, autoclavable, in three colour-codes: green, yellow and red, to allow the immediate identification of the corresponding implant diameter.

They are the exact replica of all the **LEONE** abutments, with exception for the 360° anatomical abutments for which a special kit has been reserved (page 15).

Each try-in abutment is marked with a number useful for the placement in the proper space into the kit. A transparent template over the plastic case, shows the outlines and the catalogue code numbers of each corresponding titanium abutment to facilitate the ordering of the selected type.

Only the inner tray is autoclavable.

Kit content:

4 try-in abutments each implant diameter for the different types, total 272 pcs



160-0033-04 **new** REFILL - TRY-IN ABUTMENTS STANDARD AND LARGE FOR IMPLANT 3.3 AND MAX STABILITY IMPLANT 3,75

Content:

4 sets of try-in abutments, 26 shapes each set, for implant 3.3 and **Max Stability** implants diameter 3,75

Total 104 pcs

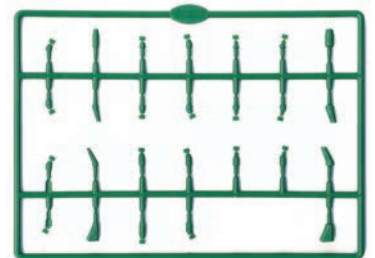

160-0041-04 **new** REFILL - TRY-IN ABUTMENTS STANDARD AND LARGE FOR IMPLANT 4.1, LEONE 6.5 SHORT IMPLANT AND MAX STABILITY IMPLANT 4,5

Content:

4 sets of try-in abutments, 26 shapes each set, for implant 4.1 mm in diameter, **LEONE 6.5** short implant and **Max Stability** implants diameter 4,5.

Total 104 pcs

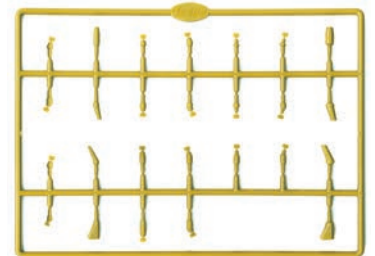

160-0048-04 **new** REFILL - TRY-IN ABUTMENTS STANDARD AND LARGE FOR IMPLANT 4.8

Content:

4 sets of try-in abutments, 16 shapes each set, for implant 4.8.

Total 64 pcs

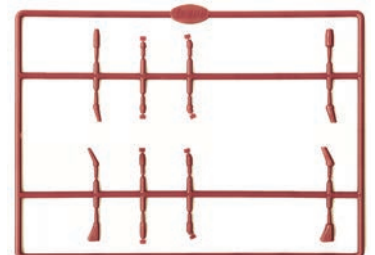

ANALOGS

Made of stainless steel. Designed to be used in the laboratory on dental casts to faithfully duplicate the position of the implant. With colour-code marking for easy identification. Available in two versions: standard and long (more retentive).

Pack content: 1 analog, 1 pin, 1 bar for the extraction of the abutment

new

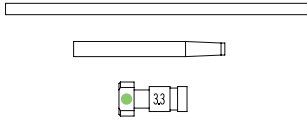
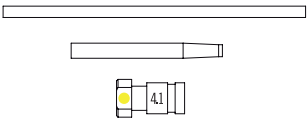
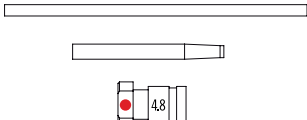
			
for implant			
∅	3,3 mm	4,1 mm	4,8 mm
length	9 mm	9 mm	9 mm
	142-3309-00	142-4109-00	142-4809-00

new

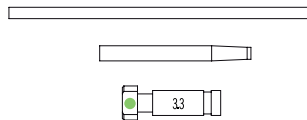
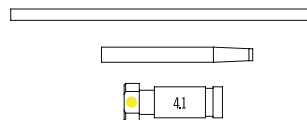
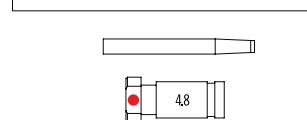
			
for implant			
∅	3,3 mm	4,1 mm	4,8 mm
length	13 mm	13 mm	13 mm
	142-3313-00	142-4113-00	142-4813-00

HANDLE FOR ABUTMENTS

Made of medical grade 5 titanium. It is used for the milling of the abutment either in the laboratory or in the dental office.

			
for implant			
inner cone ∅	2,2 mm	3,0 mm	3,7 mm
	156-1007-33	156-1007-41	156-1007-48

KEY TO SURGICAL INSTRUMENTS



for implants:
Ø 3,3 mm



for implants:
Ø 4,1 mm



for implants:
Ø 4,8 mm



for implants:
Max Stability Ø 3,75 mm



for implants:
Max Stability Ø 4,5 mm



for implants:
short 6.5









Stands for **GENERAL-PURPOSE**.
Instruments and products suitable for all dental implant diameters

MUCOSA PUNCH FOR CONTRA ANGLE

Made of medical grade 5 titanium. The corresponding implant diameter is laser marked on the body. Intended for use with a contra angle set at a low speed, it allows to punch the mucosa according to the selected implant diameter. The instruments are supplied non sterile and must be sterilised in the autoclave before use.

Pack of 1

						
for implant						
	154-3315-20	154-3815-20	154-4115-20	154-4515-20	154-4815-20	154-5015-20

151-0001-00

POSITIONER FOR DEPTH INDICATOR

Made of anodized aluminium. Designed to be used during the preparation of the implant site, it allows the right placement of the depth indicator on the drills.

Supplied non sterile, sterilise in autoclave before use.

Pack content: 1 positioner and 4 packs depth indicators (one for each diameter available)



DEPTH INDICATORS

The elastomer ringlets are to be applied on the drill to better visualize the drilling depth. Supplied non sterile, the ringlets must be sterilised in the autoclave before use. Single use.

Pack of 10

	for drill	
	Ø 2,2 mm	151-0000-01
	Ø 2,8 mm	151-0000-02
	Ø 3,5 mm	151-0000-03
	Ø 4,2 mm	151-0000-04

BURS AND DRILLS

Made of stainless steel. Diameter, length and depth marks are indicated on the body. Supplied non-sterile, burs and drills must be sterilised in autoclave before use. Replace drills used more than 20 times or in case of worn out cutting edges.

Pack of 1

ROUND BUR

Designed to mark the cortical bone for the subsequent drills.



LANCE DRILL



It is used as an alternative to the round bur, to mark the cortical bone for the subsequent drills. Particularly suitable in case of narrow knife-edged ridges.

	
for implant	
∅	1,9 mm
length	34 mm
	151-1934-01

	
for implant	
max ∅	1,9 mm
length	30 mm
	151-1930-02

PILOT DRILL











Indicated to drill the implant site. The 5 depth marks on the drill corresponding to the implant lengths (6,5-8-10-12-14 mm) enable the clinician to reach the relevant depth. Max speed: 800 rpm.

	short	long
		
for implant		
∅	2,2 mm	2,2 mm
length	33 mm	39 mm
	151-2233-12	151-2241-12

TWIST DRILL



These drills are used in progression to allow the widening of the implant site up to the relevant size. The 5 depth marks on the drill corresponding to the implant lengths (6,5-8-10-12-14 mm) enable the clinician to reach the relevant depth.

Max speed: diameter 2.8 mm 600 rpm; diameter 3.5 mm 500 rpm; diameter 4.2 mm 400 rpm.

	short	long	short	long	short	long
						
for implant						
∅	2,8 mm	2,8 mm	3,5 mm	3,5 mm	4,2 mm	4,2 mm
length	33 mm	39 mm	33 mm	39 mm	33 mm	39 mm
	151-2833-13	151-2841-13	151-3533-13	151-3541-13	151-4233-13	151-4241-13



COUNTERSINK

Suitable to shape the osteotomy for the implant neck at the end of the surgical sequence. Thanks to its self-centering multi-blade geometry, it performs a perfectly coaxial and precise countersinking hole.
Maximum speed: 300 rpm.

			
for implant			
∅	3,3 mm	4,1 mm	4,8 mm
length	33 mm	33 mm	33 mm
	151-3333-24	151-4133-24	151-4833-24





DRILLS WITH DEPTH STOP FOR LEONE 6.5 SHORT IMPLANT

With integrated depth stop at 6.5 mm. The 3,5 mm twist drill has got the crestal countersink integrated. These drills are used in progression to allow the widening of the implant site up to the **LEONE 6.5** short implant diameter.
Max speed:
PILOT - diameter 2.2 mm 800 rpm;
TWIST - diameter 2.8 mm 600 rpm;
TWIST - diameter 3.5 mm 500 rpm.

	PILOT		TWIST	
				
for implant				
∅	2,2 mm	2,8 mm	3,5 mm	
length	33 mm	33 mm	33 mm	
	151-2233-65	151-2833-65	151-3533-65	

TWIST DRILLS FOR HARD BONE

Specifically developed for **LEONE Max Stability** implants, these twist drills are to be used at the end of the surgical sequence only with hard bone, in order to avoid excessive insertion torque forces. Made of stainless steel. The 5 depth marks (6.5-8-10-12-14 mm) on the drilling body enable the clinician to reach the desired depth. Two colour-coded marks, rather than one single mark, are visible on the drill's stem and clearly distinguish them from other twist drills.
Max speed: 500 rpm for implant ∅ 3,75 mm; 400 rpm for implant ∅ 4,5 mm.
Supplied non-sterile.

	short	long	short	long
				
for implant				
length	33 mm	39 mm	33 mm	39 mm
	151-3133-13	151-3141-13	151-3833-13	151-3841-13

DRILLS WITH DEPTH STOP

A drill system with depth stops, specific for the **LEONE** implant system. The system provides accurate drilling with depth control during the preparation of the implant site, especially in case of reduced visibility of the surgical area or proximity to sensitive anatomical structures.

The drills present a depth stop, which is an integral part of the drill, stopping the osteotomy at the level of the bone crest.

The integrated depth stop determines, for each drill diameter, one specific drill for each implant length.

Besides the cylindrical cutting portion, each twist drill has the crestal countersink integrated in order to shape the coronal portion of the osteotomy for the implant neck.

The drills are available only in the short version. A drill extension for situations where longer instruments are needed is available.

The drills with depth stop are made of stainless steel. The corresponding drilling depth is indicated on the stem. Supplied non-sterile, they must be sterilised in autoclave before use.

Replace drills used more than 20 times or in case of worn out cutting edges.

Pack of 1

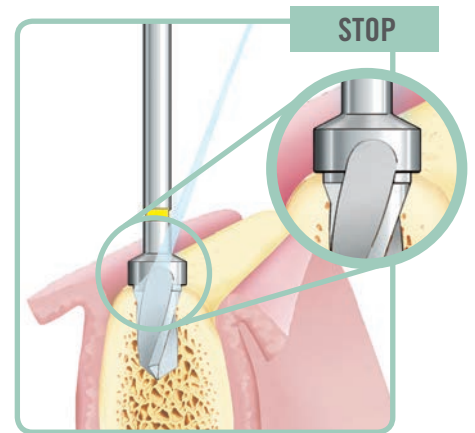

DRILL EXTENSION

Made of stainless steel. Allows to extend the total length of the drill.

Supplied non-sterile, sterilise in autoclave before use.



PILOT DRILL WITH DEPTH STOP

Max speed: 800 rpm.

for implant				
∅	2,2 mm	2,2 mm	2,2 mm	2,2 mm
drilling depth	8 mm	10 mm	12 mm	14 mm
	151-2208-12	151-2210-12	151-2212-12	151-2214-12









TWIST DRILLS WITH DEPTH STOP

These drills are used in progression to allow the widening of the implant site up to the relevant size. There is a colour-coded mark on the stem to allow the identification of the drill diameter. Each drill has the crestal countersink integrated.









Max speed:

- diameter 2,8 mm 600 rpm
- diameter 3,5 mm 500 rpm
- diameter 4,2 mm 400 rpm

TWIST DRILL WITH DEPTH STOP Ø 2,8

				
for implant				
Ø	2,8 mm	2,8 mm	2,8 mm	2,8 mm
drilling depth	8 mm	10 mm	12 mm	14 mm
	151-2808-13	151-2810-13	151-2812-13	151-2814-13

TWIST DRILL WITH DEPTH STOP Ø 3,5







				
for implant				
Ø	3,5 mm	3,5 mm	3,5 mm	3,5 mm
drilling depth	8 mm	10 mm	12 mm	14 mm
	151-3508-13	151-3510-13	151-3512-13	151-3514-13

TWIST DRILL WITH DEPTH STOP Ø 4,2

				
for implant				
Ø	4,2 mm	4,2 mm	4,2 mm	4,2 mm
drilling depth	8 mm	10 mm	12 mm	14 mm
	151-4208-13	151-4210-13	151-4212-13	151-4214-13



TAPS FOR LEONE DENTAL IMPLANTS Ø 3,3 - Ø 4,1 - Ø 4,8

Made of stainless steel. Designed for the preparation of the implant site with high bone density. The elastomer ring on the octagonal basis allows the connection with the instruments. Supplied non sterile. Sterilise in the autoclave before use.

	short	long	short	long	short	long
						
for implant						
Ø	3,3 mm	3,3 mm	4,1 mm	4,1 mm	4,8 mm	4,8 mm
length	21 mm	28 mm	21 mm	28 mm	21 mm	28 mm
	152-3321-00	152-3328-00	152-4121-00	152-4128-00	152-4821-00	152-4828-00





TAPS FOR LEONE 6.5 SHORT IMPLANT

Made of stainless steel. The use of the tap "A" is essential with any kind of bone for the placement of the short implant 6.5. The bone tap "B" is suitable with high bone density and essential to be used after tapping with bone tap "A". The elastomer ring on the octagonal basis allows the connection with the instruments. Two fuchsia colour-coded marks are present on the tap "B"'s stem to differentiate it from the bone tap "A". Supplied non sterile. Sterilise in the autoclave before use.

	Tap A	Tap B
		
for implant		
Ø	5 mm	5 mm
length	21 mm	21 mm
	152-5021-01	152-5021-02

CONNECTING RINGS

Replacement part for taps and instruments.
Made of elastomer material.
Pack of 5

		152-0000-01
		152-0000-02
		152-0000-03
		152-0000-04
		156-1002-02

RATCHET

Made of medical grade 5 titanium. The ratchet is designed to be used with the tap to thread the implant site and being a two-way instrument, it may be utilized whether to screw in or unscrew implants. With circular revolution in 24 "releases", this ratchet is a specific versatile device even in small spaces where a "reload" of the instrument is needed. Use the ratchet in connection with the tap, the implant carrier or with the specially provided extension Cat. 156-1002-00. Suitable for all types of implants. Supplied non-sterile. Sterilise in the autoclave before use. Do not disassemble the instrument.



[156-1014-00](#)

MEASURING PIN FOR GINGIVAL HEIGHT

Made of medical grade 5 titanium. 2,2 mm in diameter. With a hole for the placement of a safety leash. It is used to measure the height of the soft tissues and ascertain parallelism, during the preparation of the implant site, immediately after the application of the pilot drill. For monoimplants and implants. Supplied non sterile. Sterilise in the autoclave before use.



156-2004-00

PARALLELING PIN

Made of medical grade 5 titanium. Dimensions of the two ends: 2.2 mm and 2.8 mm in diameter. With a hole for the placement of a safety leash. Designed to be used during the preparation of the implant site to ascertain parallelism with natural teeth and/or with adjacent implant sites. For monoimplants and implants. Supplied non sterile. Sterilise in the autoclave before use.



156-2001-00

DEPTH GAUGE

Made of medical grade 5 titanium. 2,2 mm in diameter. With a hole for the placement of a safety leash. Designed to be used during the preparation of the implant site to verify the depth. For monoimplants and implants. Supplied non sterile. Sterilise in the autoclave before use.



156-2002-00

HAND SCREWDRIVER

Made of medical grade 5 titanium. Designed for use with the tap to create a thread in the implant site and afterwards to screw the implant into the bone. It fits over the tap or the implant carrier and it can be used with the specially provided extension. With a hole for the placement of a safety leash. Supplied non sterile. Sterilise in the autoclave before use.

standard

large



156-1001-00

156-1001-01

EXTENSION





Made of medical grade 5 titanium. It is used to connect the hand screwdriver or the ratchet with other instruments like tap, carrier etc. The elastomer ring on the octagonal basis allows the connection with the hand instruments. Supplied non sterile. Sterilise in the autoclave before use.



156-1002-00

DRIVER FOR IMPLANT

Made of tempered stainless steel. Designed to be used during the placement of the implant into the implant site when the carrier supplied together with the implant is not strong enough to transmit the force applied. Max torque resistance 140 Ncm. The elastomer ring on the octagonal basis allows the connection with the hand instruments. Replace drivers used more than 50 times. Available as universal version, suitable for all types of implants and as specific version for each connection size, identified by the colour code, more resistant to accidental application of bending forces. Supplied non sterile. Sterilise in the autoclave before use.

				
for implant	156-1013-00	156-1033-00	156-1041-00	156-1048-00



SUPPORT RING FOR DRIVER

Replacement part for driver for implant. Made of elastomer material. Pack of 5



156-3300-00

156-4100-00

156-4800-00

HANDPIECE ADAPTER

Made of tempered stainless steel. Supplied non-sterile, sterilise in the autoclave before use. Do not use with a torque value higher than 50 Ncm.



156-1002-01

**156-1008-00
THREADED HANDLE**

Made of stainless steel. Seating tip is screwed into the threaded handle to beat the abutment for the definitive connection to the implant. Suitable also for surgical tips. Supplied non-sterile, sterilise in the autoclave before use.



OFFSET ADAPTER FOR THREADED HANDLE

Made of stainless steel. By screwing it into the threaded handle, the execution of special surgical techniques is allowed in difficult access areas with sinus lift tips. Supplied non sterile. Sterilise in the autoclave before use.



156-1008-05

TIP WRENCH

Manufactured in stainless steel. It is used for screwing and unscrewing the tips into the threaded handle.



156-1008-07

INSTRUMENTS FOR SURGERY

Tips are made of medical grade 5 titanium. Screwed into the threaded handle, they allow the execution of special surgical techniques. With depth marks at 6,5-8-10-12-14-16-18 mm and colour-codes for easy identification. Supplied non-sterile, the tips must be sterilised in the autoclave before use.

SINUS LIFT TIP

for implant



156-1010-33



156-1010-41



156-1010-48



BONE CONDENSER TIP

for implant



156-1011-33



156-1011-41



156-1011-48



BONE GRAFT TIP

for implant



156-1012-33



156-1012-41



156-1012-48



ABUTMENT BEATER

Made of stainless steel and medical grade 5 titanium. Supplied with an inner spring, it provides the right beating force to engage the healing cap and definitely connect the abutment to the implant. Every seating tip may be mounted on the abutment beater.

156-1008-03 ABUTMENT BEATER WITH STRAIGHT TIP



156-1008-04 ABUTMENT BEATER WITH OFFSET TIP



The abutment beater with offset tip may only be used for the percussion of the abutments in the posterior region. The offset tip reduces the beating force by 30%.

SEATING TIPS FOR ABUTMENTS

Made of medical grade 5 titanium. Designed to be screwed onto the threaded handle or the abutment beater. The flat tip is most suitable for the angled abutments. Suitable for all the abutments and healing caps.

STRAIGHT TIP	156-1008-01	
OFFSET TIP	156-1008-02	
FLAT TIP	156-1008-06	

new

REMOVAL TOOL FOR ABUTMENTS

Made of stainless steel. Acting on the transmucosal portion of the abutment, it allows the application of the extraction force necessary to remove a definitively seated abutment from the implant. Two different instruments are available specific for the prosthetic platform. Both are universal instruments in regard to the three different connection sizes.

156-1022-01 FOR ABUTMENTS OF THE STANDARD PROSTHETIC PLATFORM

156-1022-02 FOR ABUTMENTS OF THE LARGE PROSTHETIC PLATFORM



INSTRUMENT FOR COVER CAPS

Made of medical grade 5 titanium. Designed for placement and removal of the cover cap from the implant. Suitable for extraction of the healing cap with Slim platform and for removal of the low self-locking cap. With a hole for the insertion of a safety leash. Suitable for all types of implants. Supplied non sterile. Sterilise in the autoclave before use.



156-1003-00

HEX HEAD EXTRACTOR FOR HEALING CAPS

Made of stainless steel. To unlock the healing cap with either Standard or Large platforms and the low self-locking cap. With a hole for the insertion of a safety leash. Suitable for all types of implants. Supplied non sterile. Sterilise in the autoclave before use. If the hexagon is worn out, replace the instrument.



156-1006-00

156-0018-00
OSTEOTOMY INSTRUMENT KIT

Entirely autoclavable, it contains all the surgical accessories for the execution of special osteotomy interventions related to the placement of **LEONE** implants.



Kit content:

- 1 round bur Cat. 151-1934-01
- 1 pilot drill long Cat. 151-2241-12
- 3 threaded handles Cat. 156-1008-00
- 1 sinus lift tip 3.3 Cat. 156-1010-33
- 1 sinus lift tip 4.1 Cat. 156-1010-41
- 1 sinus lift tip 4.8 Cat. 156-1010-48
- 1 bone condenser tip 3.3 Cat. 156-1011-33
- 1 bone condenser tip 4.1 Cat. 156-1011-41

- 1 bone condenser tip 4.8 Cat. 156-1011-48
- 1 bone graft tip 3.3 Cat. 156-1012-33
- 1 bone graft tip 4.1 Cat. 156-1012-41
- 1 bone graft tip 4.8 Cat. 156-1012-48
- 1 offset adapter for threaded handle Cat. 156-1008-05
- 1 tip wrench Cat. 156-1008-07
- 1 surgical mallet Cat. 156-1018-00
- 1 titanium basin Cat.156-1009-00

156-1018-00
SURGICAL MALLET

Manufactured in stainless steel and Teflon. Designed for osteotomy techniques, to strike the threaded handle. Supplied non sterile. Sterilise in the autoclave before use.



156-1009-00
TITANIUM BASIN

Made of medical grade 5 titanium. Useful in surgery to place instruments or titanium products on it, to avoid contamination risks.



TEMPLATE

The template helps the surgeon in selecting the right implant to be inserted. The whole range of **LEONE** implants in three scales is illustrated: actual dimensions, dimensions increased by 10% and dimensions increased by 25%, it takes into account the distortions due to the diagnostic instruments. Pack of 1

SISTEMA IMPLANTARE		leone		IMPLANT SYSTEM								
		Ortodontia e Maxillofaciale Orthodontics and Maxillofacial										
Ø (mm)	3.3				4.1				4.8			
Length	8	10	12	14	8	10	12	14	8	10	12	14
1:1												
+10%												
+25%												

156-2003-00
TEMPLATE FOR LEONE IMPLANTS

156-2003-02
TEMPLATE FOR LEONE 6.5 SHORT IMPLANT

156-2003-04
TEMPLATE FOR LEONE MAX STABILITY IMPLANTS

SURGICAL KIT

Suitable for full sterilisation in the autoclave, it includes all the surgical accessories required for treatment with the **LEONE** implant system. The package includes an explanatory card as a guide for a working sequence of the instruments.

156-0065-04

COMPREHENSIVE SURGICAL KIT

Kit content: 1 round bur, 2 pilot drills \varnothing 2.2 mm, both long and short, 6 twist drills \varnothing 2.8-3.5-4.2 mm, both long and short, 3 countersinks \varnothing 3.3-4.1-4.8 mm, 6 taps \varnothing 3.3-4.1-4.8 mm, both long and short, 1 pilot drill \varnothing 2.2 with integrated stop for **LEONE 6.5** short implant, 2 twist drills \varnothing 2.8-3.5 with integrated stop for **LEONE 6.5** short implant, 2 taps \varnothing 5 mm for **LEONE 6.5** short implant, 3 paralleling pins \varnothing 2.2 mm, 1 depth gauge \varnothing 2.2 mm, 1 hand screwdriver large, 1 extension, 1 instrument for caps, 1 ratchet, 1 hex head extractor, 1 titanium basin, 1 driver for implant, 1 hand piece adapter, 14 depth indicators for drills \varnothing 2.2-2.8-3.5-4.2 mm

156-0065-03

SURGICAL KIT FOR LEONE IMPLANTS \varnothing 3,3-4,1-4.8 WITH LONG AND SHORT INSTRUMENTS

156-0065-02

SURGICAL KIT FOR LEONE IMPLANTS \varnothing 3,3-4,1-4.8 WITH LONG INSTRUMENTS

156-0065-01

SURGICAL KIT FOR LEONE IMPLANTS \varnothing 3,3-4,1-4.8 WITH SHORT INSTRUMENTS

156-0065-00

EMPTY SURGICAL KIT

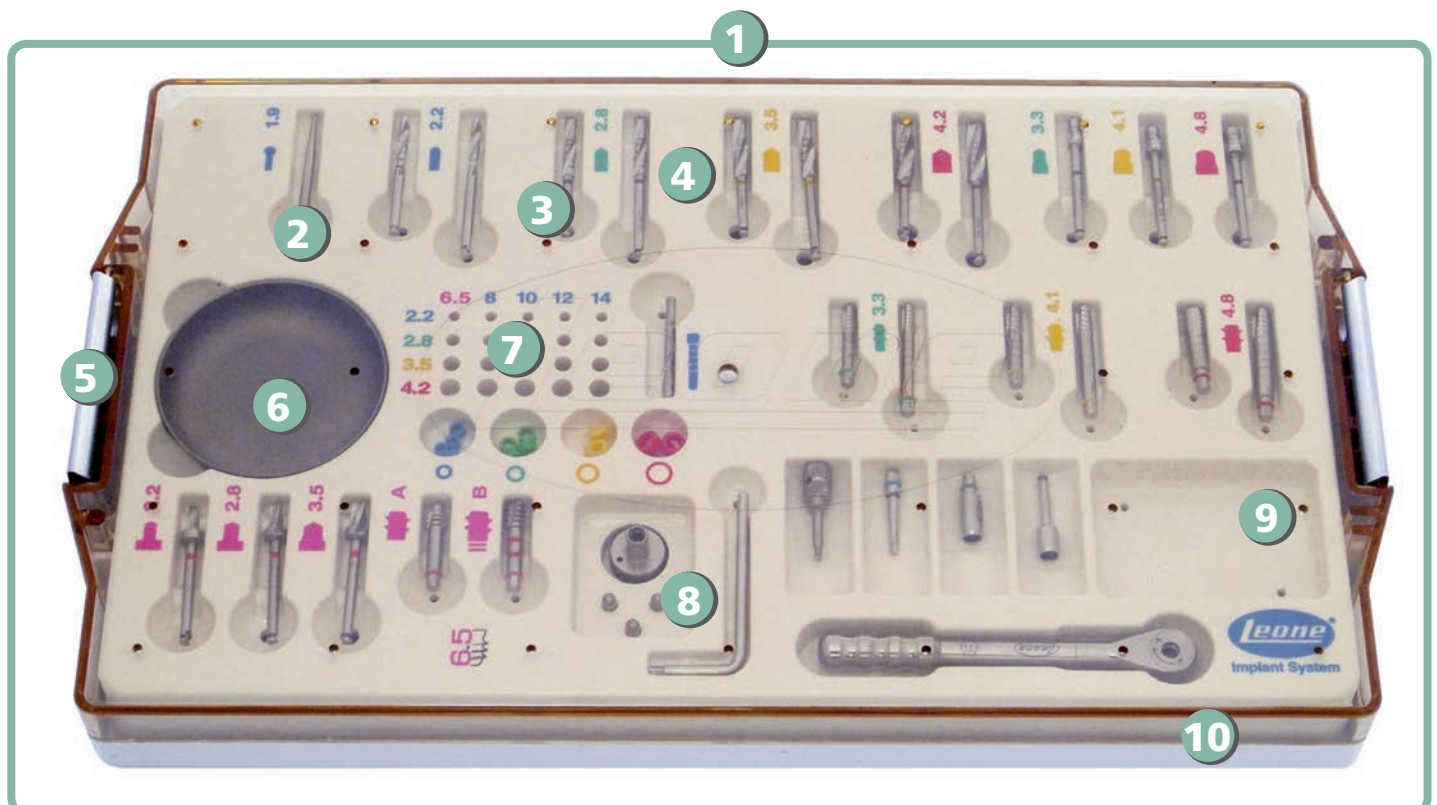



1 WIDER FIELD OF VISION
the instruments are organized in a horizontal sense into special niches



6 TITANIUM BASIN
useful for implants and instruments to reduce contamination risks

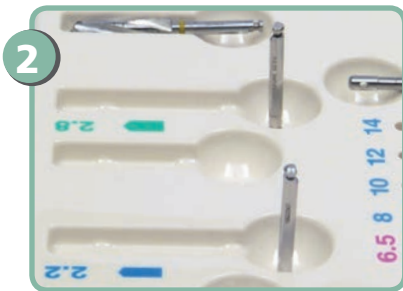

2 CALIBRATED HOLES
for the control of drill diameter



7 DEPTH INDICATORS AND POSITIONER
are ready available in the kit



3 SAFE HOLD OF CUTTING INSTRUMENTS
due to ergonomically designed niches



8 SMOOTH SURFACES WITHOUT UNDERCUTS
for rapid cleaning without damage of the gloves

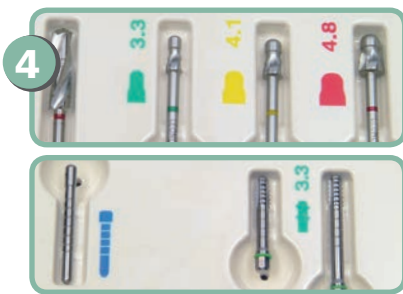

4 EASY REPLACEMENT OF INSTRUMENTS WITHOUT MISTAKE
each instrument shape is designed near each niche

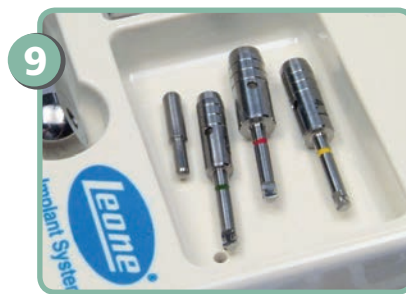

9 FREE SPACE
to customize the kit with additional surgical instruments

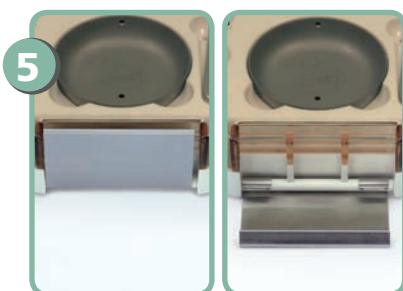

5 RELIABLE AND SAFE LOCK SYSTEM
prevents from any accidental opening



10 REDUCED SIZES
only 3 cm thick

ORGANIZER

Suitable for full sterilisation in the autoclave. It contains the necessary instruments for the preparation of the implant site positioned on the special colour-coded support. The package includes an explanatory card as a guide for a working sequence of the instruments on the basis of the selected implant diameter. The organizer is also available empty to give the possibility for the user to customize it.



ORGANIZER FOR IMPLANT Ø 3,3

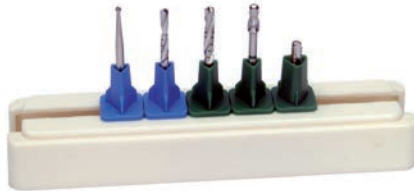

156-0022-33 SHORT INSTRUMENTS

151-1934-01	round bur
151-2233-12	pilot drill
151-2833-13	twist drill 2,8
151-3333-24	countersink 3,3
152-3321-00	tap 3,3

156-0023-33 LONG INSTRUMENTS

151-1934-01	round bur
151-2241-12	pilot drill
151-2841-13	twist drill 2,8
151-3333-24	countersink 3,3
152-3328-00	tap 3,3

ORGANIZER FOR IMPLANT Ø 4,1



156-0020-41 SHORT INSTRUMENTS

151-1934-01	round bur
151-2233-12	pilot drill
151-2833-13	twist drill 2,8
151-3533-13	twist drill 3,5
151-4133-24	countersink 4,1
152-4121-00	tap 4,1

156-0021-41 LONG INSTRUMENTS

151-1934-01	round bur
151-2241-12	pilot drill
151-2841-13	twist drill 2,8
151-3541-13	twist drill 3,5
151-4133-24	countersink 4,1
152-4128-00	tap 4,1

ORGANIZER FOR IMPLANT Ø 4,8



156-0024-48 SHORT INSTRUMENTS

151-1934-01	round bur
151-2233-12	pilot drill
151-2833-13	twist drill 2,8
151-3533-13	twist drill 3,5
151-4233-13	twist drill 4,2
151-4833-24	countersink 4,8
152-4821-00	tap 4,8

156-0025-48 LONG INSTRUMENTS

151-1934-01	round bur
151-2241-12	pilot drill
151-2841-13	twist drill 2,8
151-3541-13	twist drill 3,5
151-4241-13	twist drill 4,2
151-4833-24	countersink 4,8
152-4828-00	tap 4,8

**ORGANIZER
FOR 6.5 SHORT IMPLANT**

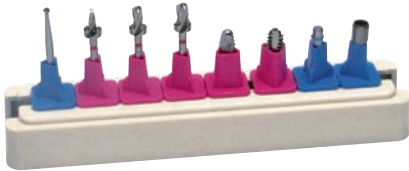

156-0019-00

151-1934-01	round bur
151-2233-65	pilot drill with stop
151-2833-65	twist drill 2,8 with stop
151-3533-65	twist drill 3,5 with stop
152-5021-01	tap "A"
152-5021-02	tap "B"
156-1013-00	driver for implant
156-1002-01	handpiece adapter

**ORGANIZER
FOR IMPLANTS Ø 3,3 - 4,1 - 4,8**



**156-0026-00
SHORT INSTRUMENTS**

151-1934-01	round bur
151-2233-12	pilot drill
151-2833-13	twist drill 2,8
151-3533-13	twist drill 3,5
151-4233-13	twist drill 4,2
151-3333-24	countersink 3,3
151-4133-24	countersink 4,1
151-4833-24	countersink 4,8

**156-0027-00
LONG INSTRUMENTS**

151-1934-01	round bur
151-2241-12	pilot drill
151-2841-13	twist drill 2,8
151-3541-13	twist drill 3,5
151-4241-13	twist drill 4,2
151-3333-24	countersink 3,3
151-4133-24	countersink 4,1
151-4833-24	countersink 4,8

**ORGANIZER
FOR MAX STABILITY Ø 3,75**



**156-0028-38
SHORT INSTRUMENTS**

151-1934-01	round bur
151-2233-12	pilot drill
151-2833-13	twist drill 2,8
151-3333-24	countersink 3,3
151-3133-13	for hard bone imp. 3,75
156-1002-01	handpiece adapter
156-1013-00	driver for implant

**156-0029-38
LONG INSTRUMENTS**

151-1934-01	round bur
151-2241-12	pilot drill
151-2841-13	twist drill 2,8
151-3333-24	countersink 3,3
151-3141-13	for hard bone imp. 3,75
156-1002-01	handpiece adapter
156-1013-00	driver for implant

**ORGANIZER
FOR MAX STABILITY Ø 4,5**



**156-0030-45
SHORT INSTRUMENTS**

151-1934-01	round bur
151-2233-12	pilot drill
151-2833-13	twist drill 2,8
151-3533-13	twist drill 3,5
151-4133-24	countersink 4,1
151-3833-13	for hard bone imp. 4,5
156-1002-01	handpiece adapter
156-1013-00	driver for implant

**156-0031-45
LONG INSTRUMENTS**

151-1934-01	round bur
151-2241-12	pilot drill
151-2841-13	twist drill 2,8
151-3541-13	twist drill 3,5
151-4133-24	countersink 4,1
151-3841-13	for hard bone imp. 4,5
156-1002-01	handpiece adapter
156-1013-00	driver for implant

ORGANIZER WITH DRILLS WITH DEPTH STOP



156-0032-08

ORGANIZER WITH DRILLS WITH DEPTH STOP AT 8 mm

151-2208-12	pilot drill Ø 2,2 with stop at 8 mm
151-2808-13	twist drill Ø 2,8 with stop at 8 mm
151-3508-13	twist drill Ø 3,5 with stop at 8 mm
151-4208-13	twist drill Ø 4,2 with stop at 8 mm
156-1019-00	drill extension

156-0033-10

ORGANIZER WITH DRILLS WITH DEPTH STOP AT 10 mm

151-2210-12	pilot drill Ø 2,2 with stop at 10 mm
151-2810-13	twist drill Ø 2,8 with stop at 10 mm
151-3510-13	twist drill Ø 3,5 with stop at 10 mm
151-4210-13	twist drill Ø 4,2 with stop at 10 mm
156-1019-00	drill extension

156-0034-12

ORGANIZER WITH DRILLS WITH DEPTH STOP AT 12 mm

151-2212-12	pilot drill Ø 2,2 with stop at 12 mm
151-2812-13	twist drill Ø 2,8 with stop at 12 mm
151-3512-13	twist drill Ø 3,5 with stop at 12 mm
151-4212-13	twist drill Ø 4,2 with stop at 12 mm
156-1019-00	drill extension

156-0035-14

ORGANIZER WITH DRILLS WITH DEPTH STOP AT 14 mm

151-2214-12	pilot drill Ø 2,2 with stop at 14 mm
151-2814-13	twist drill Ø 2,8 with stop at 14 mm
151-3514-13	twist drill Ø 3,5 with stop at 14 mm
151-4214-13	twist drill Ø 4,2 with stop at 14 mm
156-1019-00	drill extension

SET OF 4 ORGANIZERS WITH DRILLS WITH DEPTH STOP AND TAPS

156-0044-00

156-0032-08	1 organizer with drills with stop at 8 mm	152-3321-00	1 short tap 3,3
156-0033-10	1 organizer with drills with stop at 10 mm	152-4121-00	1 short tap 4,1
156-0034-12	1 organizer with drills with stop at 12 mm	152-4821-00	1 short tap 4,8
156-0035-14	1 organizer with drills with stop at 14 mm	151-1934-01	2 round burs

ORGANIZER WITH TAPS



156-0011-00 SHORT INSTRUMENTS

152-3321-00	tap 3,3
152-4121-00	tap 4,1
152-4821-00	tap 4,8

156-0012-00 LONG INSTRUMENTS

152-3328-00	tap 3,3
152-4128-00	tap 4,1
152-4828-00	tap 4,8

ORGANIZER WITH INSTRUMENTS



156-0013-00

156-1002-00	extension	156-1002-01	hand piece adapter
156-1001-01	hand screwdriver large	156-2002-00	depth gauge
156-1006-00	hex-head extractor	156-2001-00	paralleling pin
156-1003-00	instrument for cover caps	156-1013-00	driver for implant

156-0010-00 EMPTY ORGANIZER

Composed of base, cover and explanatory card

DEMONSTRATION ANATOMICAL MODELS

Made of resin, two materials: transparent and white. Demonstration models with the bone in transparent resin and the sensitive dental structures (roots, impacted teeth, mandibular nerve) highlighted in white resin.



106-0004-00

DEMONSTRATION ANATOMICAL MODEL - UPPER ARCH

Anatomical model of the complete upper arch; within the bone are clearly visible two impacted canines and the roots of the natural teeth.



106-0005-00

DEMONSTRATION ANATOMICAL MODEL - LOWER ARCH

Anatomical model of a complete lower arch; within the bone are clearly visible the mandibular nerve, the roots of the natural teeth and an impacted tooth.



106-0006-00

DEMONSTRATION ANATOMICAL MODEL - SEGMENT

Anatomical model of a segment of the lower arch; within the bone are clearly visible the mandibular nerve and the roots of the natural teeth.

106-0002-00

DEMONSTRATION SURGICAL KIT

Designed to be used by the clinician to simulate the most relevant surgical phases of the **LEONE** Implant System. The content of the kit is intended for demonstration use only and must not be used on patient.

Kit content:

- 1 hemi-mandible,
- 1 non sterile implant Ø 4.1, 10 mm long with cover cap and 5 cover caps Ø 4.1 refills,
- 1 instrument for cover caps,
- 1 standard transfer Ø 4.1,
- 1 standard healing cap Ø 4.1 mm GH 3 mm,
- 1 standard hand screwdriver,
- 1 hex-head extractor,
- 1 standard cylinder abutment Ø 4.1 mm



106-0001-00

HEMI-MANDIBLE

Made of polyurethane. The hemi-mandible presents a hole for the placement of a implant Ø 4.1 mm, 10 mm long.



106-0003-00

DEMONSTRATION JUMBO DENTAL IMPLANT

Made of aluminium. It is a scale 5:1 reproduction of **LEONE** implant Ø 4.1, 10 mm long and standard cylinder abutment Ø 4.1. Use the rod included in the package for removal of the abutment from the jumbo implant which presents a hole in the posterior part just for this operation.



DENTAL IMPLANT IDENTITY CARD

Each **LEONE** implant is supplied with this important document including the general information of the implant both for the patient and for the doctor where to take note of the features of the seated implants. These information will be essential in case of need for dental assistance later.



PATIENT INFORMATIVE BROCHURE

Available in Italian or Spanish only.



LEONE MONOIMPLANTS

for overdenture O-ring

LEONE monoimplants for O-ring overdenture are made of medical grade 5 titanium. Self-tapping shaped, with thread in accordance with ISO standard and designed to obtain an excellent primary stability. The body of **LEONE** monoimplant for O-ring overdenture is treated with a sandblasting process producing a roughness $R_a = 1 \mu\text{m}$ purposely designed to ensure a rapid osteointegration. The smooth, transmucosal tapered neck enhances gingival healing.

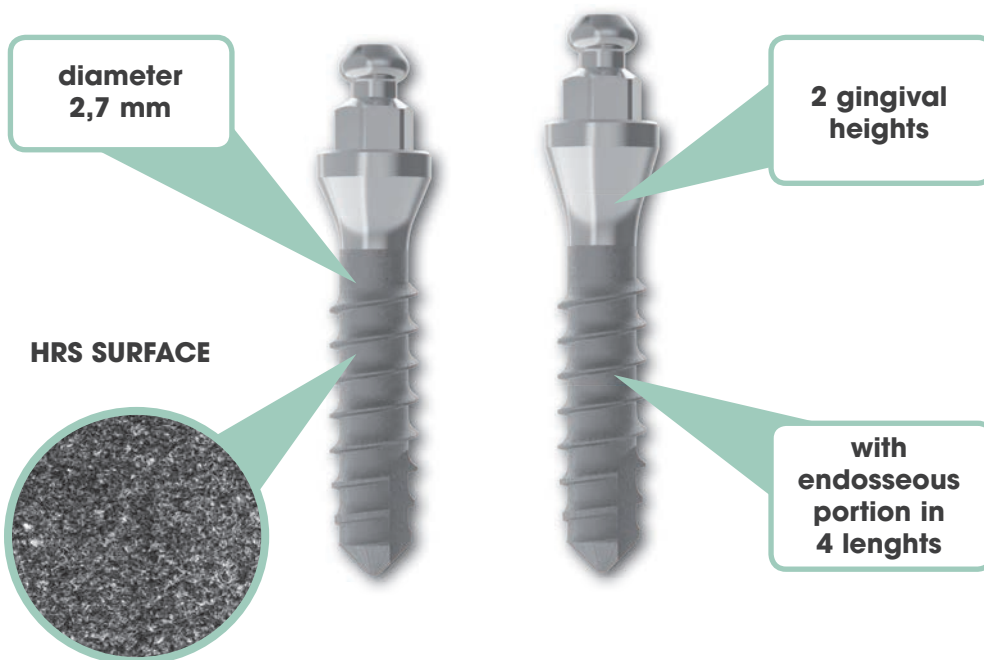

LEONE monoimplants for O-ring overdenture are available:

- 2.7 mm in diameter
- with endosseous portion in four lengths: 10 mm - 12 mm - 14 mm - 16 mm
- in two gingival heights: 3 mm - 5 mm

The micro housing is made of medical grade 5 titanium as well. Outer diameter of 4,2 mm, height: 2,8 mm

The package includes a spacer ring for monoimplants to facilitate the correct incorporation of the micro housing with O-ring into the removable denture. The spacer ring can also be used for the incorporation of the housing with O-ring into the denture when used in combination with monoimplants.

Only a few instruments are necessary for the placement of the **LEONE** monoimplants, the complete range is illustrated in the following pages.

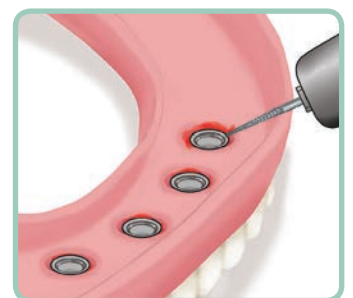
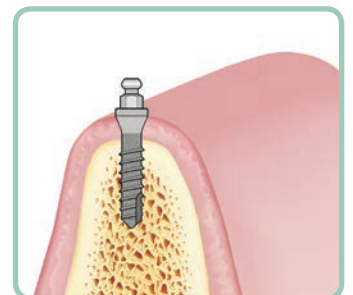
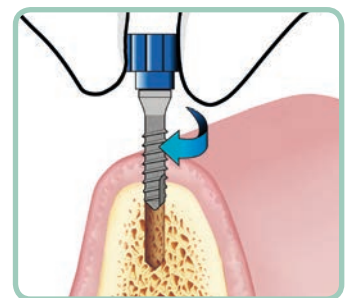
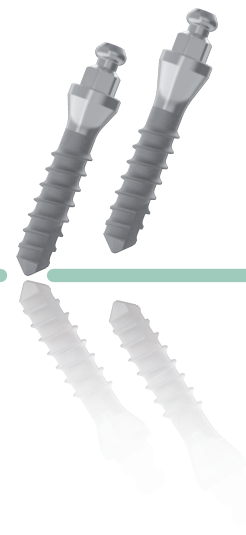





MONOIMPLANTS FOR O-RING OVERDENTURE





Made of medical grade 5 titanium. Single supplied mounted on a monoimplant carrier, and packed in gamma-ray sterile glass vial. A non sterile micro housing is supplied in a plastic vial.

Pack content:

- 1 monoimplant,
- 1 micro housing with O-ring,
- 1 spacer ring for monoimplants (white),
- 1 low spacer ring for abutments (grey)

new

				
gingival height	3 mm	3 mm	3 mm	3 mm
∅	2,7 mm	2,7 mm	2,7 mm	2,7 mm
length	10 mm	12 mm	14 mm	16 mm
	111-2710-13	111-2712-13	111-2714-13	111-2716-13

				
gingival height	5 mm	5 mm	5 mm	5 mm
∅	2,7 mm	2,7 mm	2,7 mm	2,7 mm
length	10 mm	12 mm	14 mm	16 mm
	111-2710-15	111-2712-15	111-2714-15	111-2716-15

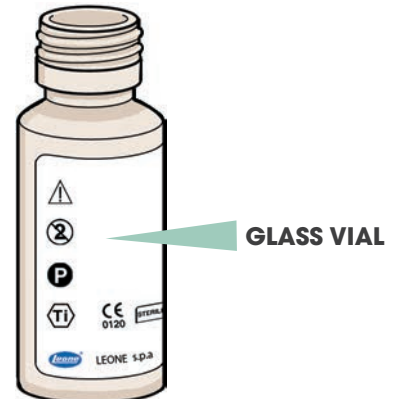
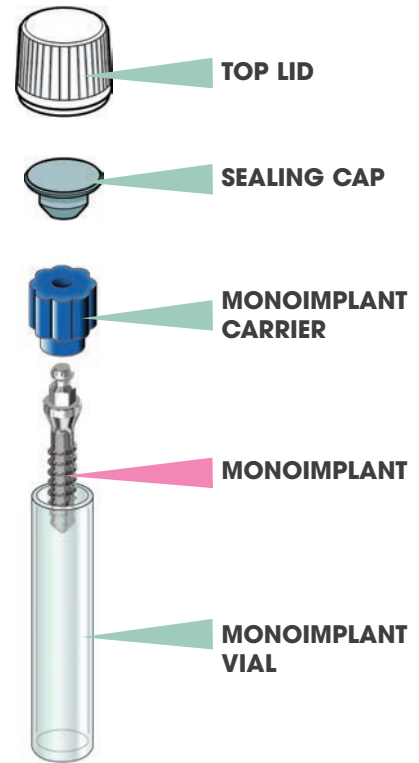

HOUSING WITH O-RING

Made of medical grade 5 titanium. Outer diameter: 5,4 mm, height: 3,1 mm.

Pack content:

- 1 housing with O-ring,
- 1 low spacer ring for abutments

new

MICRO HOUSING WITH O-RING

Made of medical grade 5 titanium. Outer diameter: 4,2 mm, height: 2,8 mm.

Pack content:

- 1 micro housing with O-ring,
- 1 low spacer ring for abutments (grey),
- 1 spacer ring for monoimplants (white)

new

ELASTOMERIC O-RING

Pack of 2



ELASTOMERIC MICRO O-RING

Pack of 2



156-0017-00

ORGANIZER FOR MONOIMPLANTS FOR O-RING OVERDENTURE

Designed to sterilize and hold the instruments necessary for the planned intervention on the operating table. It holds up 8 instruments mounted on the special supports and it can be sterilised in the autoclave.

Composition:

- 1 round bur Cat. 151-1934-01
- 1 pilot drill, long Ø 2.2 mm Cat. 151-2241-12
- 1 mucosa punch for handpiece Cat. 151-2215-20
- 1 depth gauge Ø 2.2 mm Cat. 156-2002-00
- 1 fan-type wrench for monoimplants Cat. 156-1015-00
- 2 measuring pin for gingival height Cat. 156-2004-00
- 1 adapter for handpiece Cat. 156-1017-00



MUCOSA PUNCH FOR HANDPIECE

Circular mucosa punch of titanium, 2.7 mm in diameter, to be seated into the handpiece. It allows to perform an adequate operculum in the flapless procedure. With 3 marks at 3, 5 and 7 mm starting from the bone crest and useful for the measurement of the gingival thickness. Supplied non sterile, sterilise in the autoclave before use.

Pack of 1



151-2215-20

MEASURING PIN FOR GINGIVAL HEIGHT

Made of medical grade 5 titanium, 2.2 mm in diameter, with a hole for the placement of a safety leash. To be employed immediately afterwards the use of the pilot drill to detect the height of soft tissues and parallelism of the implant sites. Supplied non sterile, sterilise in the autoclave before use.

Pack of 1



156-2004-00

DEPTH GAUGE

Made of medical grade 5 titanium, 2.2 mm in diameter, with a hole for the placement of a safety leash. To be employed during the preparation of the implant site to verify the depth and parallelism of the implant sites. For monoimplants and implants. Supplied non sterile, sterilise in the autoclave before use.

Pack of 1



156-2002-00

FAN-TYPE WRENCH FOR MONOIMPLANTS

Made of stainless steel and anodized aluminium. With hexagonal hole matching with the monoimplant head. Sidewise presents a hole for the placement of a safety leash. It is necessary for the placement of the monoimplant into the implant site. Supplied non sterile, sterilise in the autoclave before use.

Pack of 1



156-1015-00

ADAPTER FOR RATCHET

It allows the use of the ratchet Cat. 156-1014-00 for the placement of the monoimplants. Supplied non sterile, sterilise in the autoclave before use.

Pack of 1

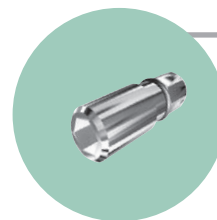

156-1016-00

ADAPTER FOR HANDPIECE

It allows the use of the handpiece during the placement of the monoimplants. Supplied non sterile, sterilise in the autoclave before use.

Pack of 1

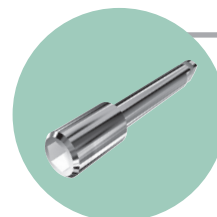

156-1017-00

156-2003-01 TEMPLATE FOR MONOIMPLANT

The template helps the surgeon in selecting the right monoimplant to be seated. The whole range of **LEONE** monoimplants GH3 in three scales is illustrated: actual dimensions, dimensions increased by 10% and dimensions increased by 25% for possible distortions due to the diagnostic instruments.

Pack of 1

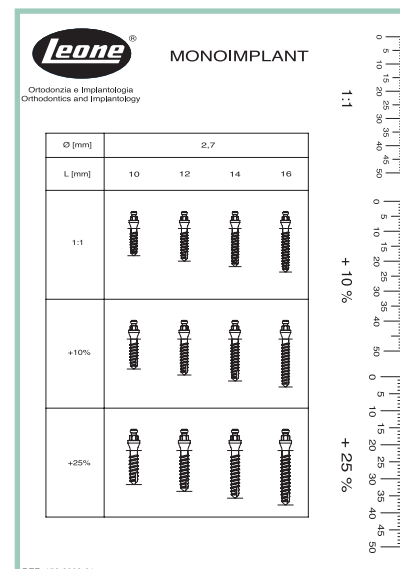

SURGICAL

procedure



2015

for



implant system

DISCLAIMER

The Surgical Procedure and the use of the products of the LEONE Implant System described in the following pages are intended for Professionals experienced in dental implant techniques.

In case of lack of basic notions, we suggest to attend specific courses in order to reach a high level of knowledge and practice in the use of implants. The rules on the use of the products described below represent a group of standard instructions that must be adjusted to the single needs and to the particular situations that may occur according to the manual ability, to the experience and to the diagnosis made by the legally qualified medical operator. It is not ascribed to the manufacturer the duty of monitoring the procedures of use of the product. A correct and appropriate use of the instruments and products related to the **LEONE** Implant System shall completely be reverted to the clinician. The surgical procedure hereunder described is merely indicative as any single treatment case is assigned to the experience of the operator. As every medical operator well knows, a correct procedure and a perfect manufacture of the prosthesis may sometimes be followed by not satisfactory results owing to particular situations not imputable to responsibility of the dental operator or the manufacturer.

TREATMENT PLANNING

Indications

Implant therapy is indicated in the treatment of the following conditions:

SINGLE-TOOTH EDENTULISM, DISTAL EDENTULISM, MULTIPLE EDENTULISM, TOTAL EDENTULISM.

Contraindications

For contraindications and side effects read the instructions for use enclosed in the package of each product and available in our web site www.leone.it.

PREOPERATIVE EXAMS

Before starting the surgical intervention, the patients have to be subjected to a series of exams; single cases have to be evaluated in the opinion of the clinician.

Anamnesis

It is the first approach to the patient and it represents a fundamental tool to recognize both risk factors and contraindications. Moreover, anamnesis allows for the evaluation of patient's expectations and priorities and of patient's degree of compliance and motivation. Anamnesis can help in evaluating the need for extra exams in addition to the routine ones (when the presence of pathologies that were not reported by the patient is suspected) and when particular situations drive to deem a complete medico-surgical exam necessary.

Objective exam

It consists of:

- inspection of the periodontal tissues, of the oral mucosa and of the teeth along with an initial evaluation of the occlusal relationships (skeletal Class, characteristics of the opposing arch and related potential problems, type of occlusion, interarch distance), of the presence of parafunctions, of the degree of oral hygiene, of the aesthetic conditions, of the morphology of the edentulous crest and the space available for the replacement of the prosthesis.
- palpation of the soft tissues and implant sites with a first evaluation of the bone morphology and thickness.
- a complete periodontal probing for the appraisal of the absence of both gingivitis and pockets.
- Examination of the dental casts mounted in an articulator for a comparison with the information derived from previous exams, creation of a diagnostic set-up, and, if necessary, the implementation of a surgical template.

Radiographic exams

PANORAMIC RADIOGRAPH: frequently, this radiograph enables to appraise bone height and the relationships between implant site and adjacent structures, such as maxillary sinuses, nasal cavities, and mandibular canal. It is also possible to identify concavities and ossification defects due to previous tooth extractions.

INTRAORAL RADIOGRAPH: it is very helpful for the determination of the mesio-distal distance between the roots, and the apico-coronal availability of bone.

LATERAL CEPHALOGRAM: it is useful when interventions on the mandibular symphysis are planned.

COMPUTERIZED TOMOGRAPHY: it is advisable to remind that previous radiographic exams provide two-dimensional images which do not give information on bone thickness. In order to obtain this useful information a computerized tomography is necessary: it provides three-dimensional images, thus allowing for an accurate evaluation of bone morphology and, sometimes, bone density.

Instrumental or laboratory exams or medical advices

When necessary, in cases where a pathology is suspected on the basis of anamnesis or clinical records.

IMPLANT SELECTION

The number and dimensions (diameter and length) of the implants to be seated are determined by the following factors:

1. amount of bone available
2. characteristics of the implant site
3. masticatory load
4. aesthetic results
5. type of the prosthetic restoration
6. type of the surgical procedure followed

Further and particular single situations must be evaluated by the clinician.

Templates (page 39) are available showing all **LEONE** implants in actual dimensions, with dimensions increased by 10% and increased by 25%, to match possible distortions created by the instrument for radiographic examinations (CT, panoramic radiograph, standard and digital cephalograms). Superimpose the template to the radiograph in order to select the implant in relation to the quantity of bone available.

Do not seat a single \varnothing 3.3 mm implant in molar position.

The \varnothing 3.3 mm implant, length 8 mm, must be used as a supplementary implant in the prosthesis composed of two or more implants of any diameter and length.

The **LEONE 6.5 short implant is intended for use only in cases with limited vertical bone availability. It is not intended to be associated with sinus lift procedures.**

Do not place the **LEONE implants above the level of the alveolar crest.**

The **LEONE** implant system is characterized by a high mechanical resistance validated through fatigue strength testing according to the ISO 14801 international standard, which indicates to perform testing with a cyclic loading at an angle of 30° with respect to the implant-abutment axis. For the **LEONE** implants of minor diameter, and thus the most relevant ones, the results are: \varnothing 3,3 mm and \varnothing 3,75 mm implant fatigue strength: 240 N; \varnothing 4,1 mm, \varnothing 4,5 mm and **LEONE 6.5** short implant fatigue strength: 392 N.^[1,2]

In the literature, in comparison, it is reported that the average force generated during mastication is 145 N with inclinations up to 10°. ^[3,4] It should also be underlined that very high masticatory forces^[5] can be generated due to many individual and prosthetic factors, such as crown height, cantilever and restoration type, which locally can exceed the strength limit of the implants, especially in case of single or unsplinted implants.

^[1] ISO 14801:2007 (E), Dentistry - Implants - Dynamic fatigue test for endosseous dental implants, International Organization for Standardization, Geneva, 2007

^[2] Barlattani A, Sannino G, Mechanical evaluation of an implant-abutment self-locking taper connection: finite element analysis and experimental tests, Int J Oral Maxillofac Implants 2013; 28:e17-e26

^[3] Carlsson GE, Haraldson T. Functional response. In: Branemark P-1, Zarb GA, Albrektsson T. Eds. Tissue integrated prostheses. Osseointegration in clinical dentistry. Chicago: Quintessence, 1985:155-63

^[4] Graf H. Occlusal forces during function. In: Proceedings of Symposium on Occlusion: Research on Form and Function. University of Michigan School of Dentistry, Ann Arbor: Rowe NH (Ed.), 1975:90-111

^[5] Craig RG. Restorative dental material. 6th ed. St. Louis, C.V. Mosby, 1980

SURGICAL KIT AND ORGANIZER

The surgical kit, (page 40), completely autoclavable, contains all the necessary surgical instruments for the implant treatments with the **LEONE** Implant System.

To simplify the surgical operation, a surgical kit with reduced dimensions, an organizer (pages 42-44) was conceived by **LEONE** to sterilize and hold the necessary instruments on the operation field.

The organizer is fully autoclavable and it can contain up to 8 instruments on colour coded special supports.

Either the organizer or the surgical kit must be wrapped and sterilized before use.

The sterilization must be done as follows:

- wrap the organizer or the kit into a sterilization bag as requested by the manufacturer of the sterilizing machine;
- autoclave at 121° (250°F) for 20 minutes;
- remove the organizer from the autoclave and leave it cool inside the bag;
- leave the organizer or the kit inside the bag to preserve sterility.



LEONE IMPLANT PACKAGING



THE PACKAGING

The packaging features a double protection to preserve the sterility of the implant subjected to a certified gamma x-ray process. A removable part of the label showing the information of the implant (see label symbols at page 125) is to be applied on the “Identity card” of the implant or on the clinical case sheet of the patient. A sterility indicator is present on the glass vial.

THE GLASS VIAL

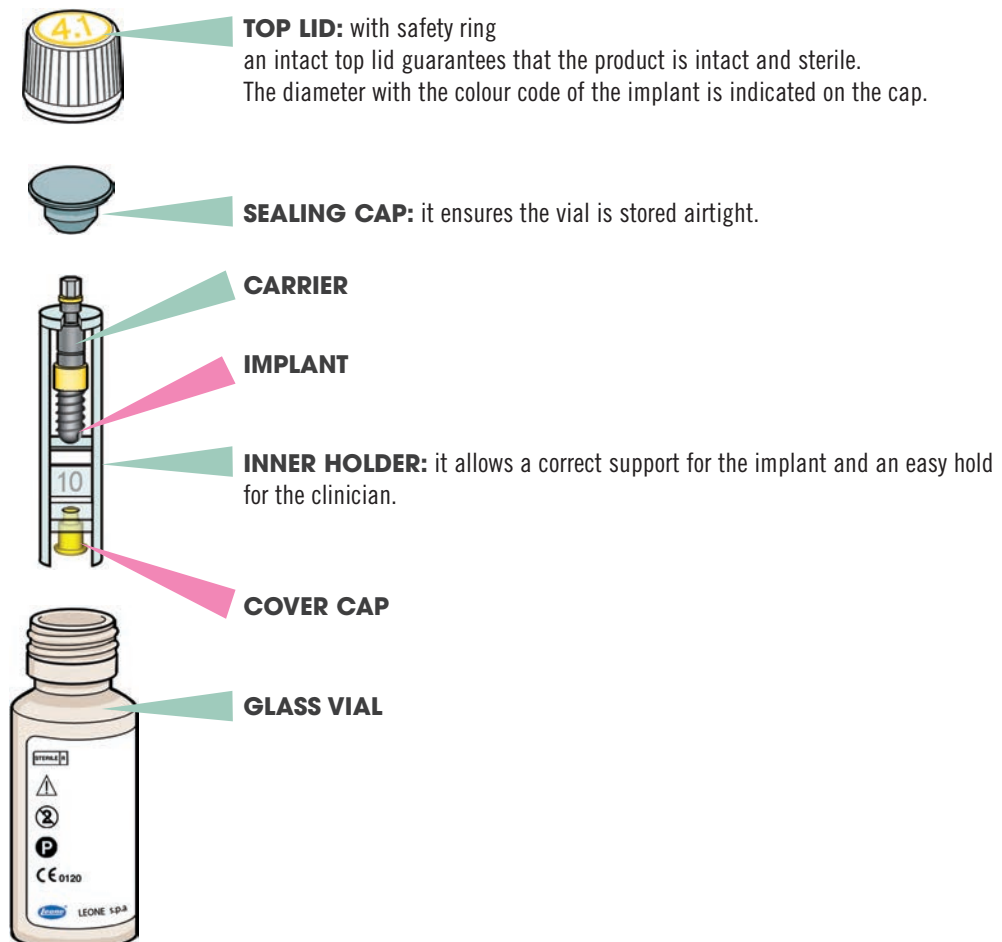

1) LEONE IMPLANTS Ø 3,3 - 4,1 - 4,8: PREPARATION OF THE IMPLANT SITE



The typology and the access to the surgical site shall be selected by the professional according to the clinical-morphological parameters. Schematically and with illustrative purpose only, the following steps for the preparation of the implant site are illustrated.

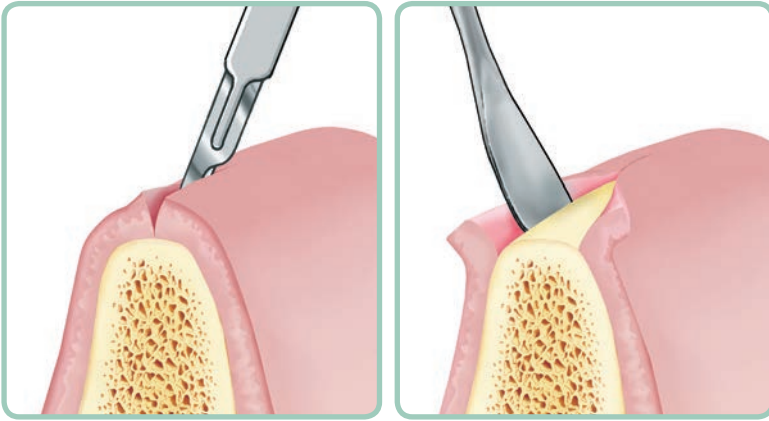

1.1a Make full-thickness incision of the soft tissues and detachment of the gingival flaps to have access to the bone ridge.

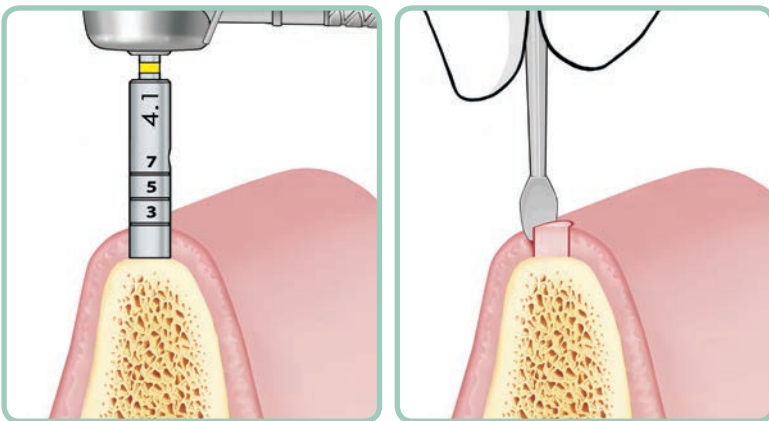

1.1b If flapless procedure is followed, use the mucosa punch for contra-angle of the same diameter of the implant. Set the handpiece to low speed (approx. 40 rpm). Use until bony tissue is met. To determine the gingival thickness around the implant area, the three black lines clearly visible around the mucosa punch, at the heights of 3-5-7 mm, starting from the crest bone, may be used. Remove the tissue plug by using a small periosteal elevator.

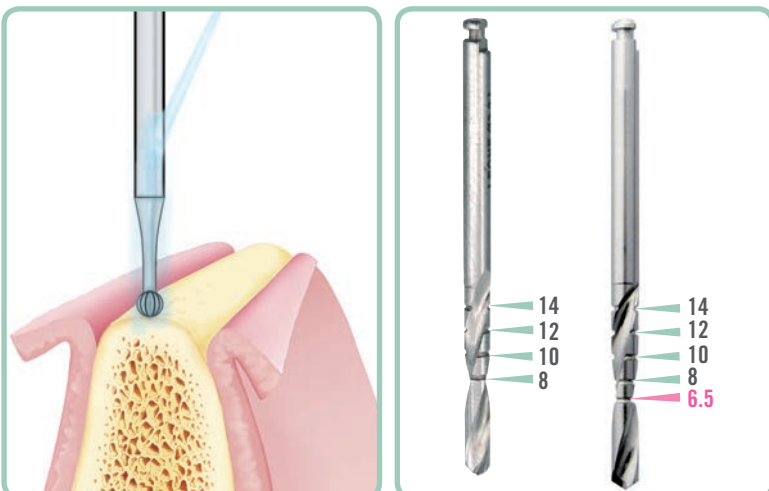

1.2 Use of the round bur Cat. 151-1934-01 to mark the cortical bone for the subsequent drills. Alternatively, it is possible to use the lance drill Cat. 151-1930-02, which is particularly suitable in case of narrow knife-edged ridges.

1.3 Prior to using any pilot or twist drill, it is important to check the number of the marks on the body of each drill:
- drills with 4 marks: 8 – 10 – 12 – 14 mm
- drills with 5 marks: 6.5 – 8 - 10 – 12 – 14 mm

The use of the depth indicators is recommended to better visualize the drilling depth. The depth indicators are made of elastomer, for single use, manufactured in the colour code related to each implant diameter.

The depth indicators and the special positioner (Cat. 151-0001-00 page 30), available either in the kit or single supplied, must be sterilized in the autoclave before use. Choose the elastomer ringlet matching the diameter of the drill to be used (Ø 2.2 mm pilot drill, blue colour, Ø 2.8 mm twist drill, green colour, Ø 3.5 mm twist drill, yellow colour, Ø 4.2 mm twist drill, red colour).

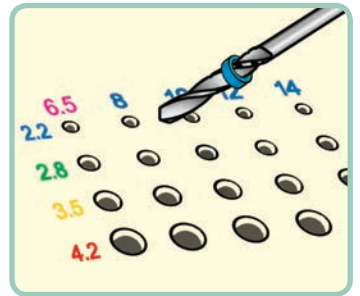
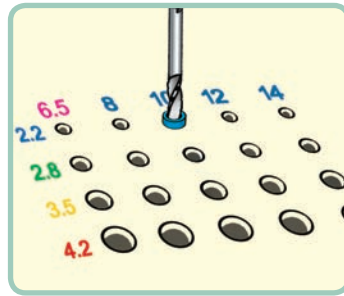
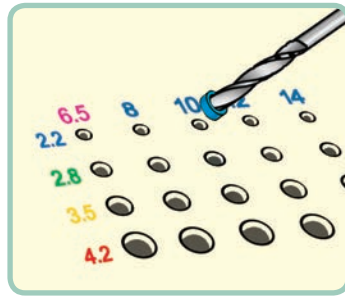
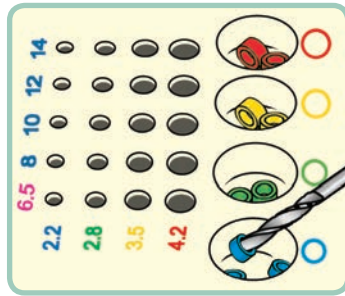

1.4 Seat the ringlet on the tip of the drill.

1.5 Placement of the drill into the hole corresponding to the diameter of the instrument and the selected depth.

1.6 Push the drill all the way to the stop.

1.7 In this way the depth indicator will be driven into position with the corresponding mark for the selected depth.

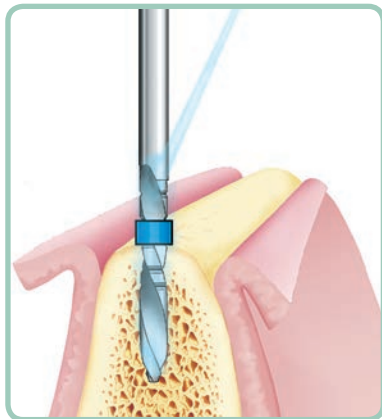

1.8 Use of the Ø 2,2 mm pilot drill: drill up to the depth mark corresponding to the length of the selected implant. (Max speed: 800 rpm with adequate irrigation)

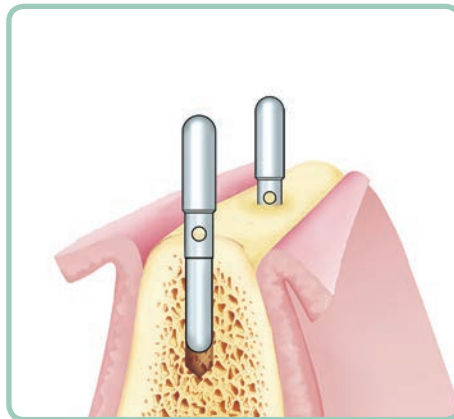

1.9a Use of paralleling pins for the control of parallelism with natural teeth and/or other adjacent implant sites. A radiographic exam can be performed to increase accuracy in the evaluation of parallelism. The paralleling pin can also be utilized after the application of a Ø 2.8 mm twist drill, taking care to seat the pin in the implant site from the side with larger diameter. Paralleling pins present a hole for the placement of a safety leash.

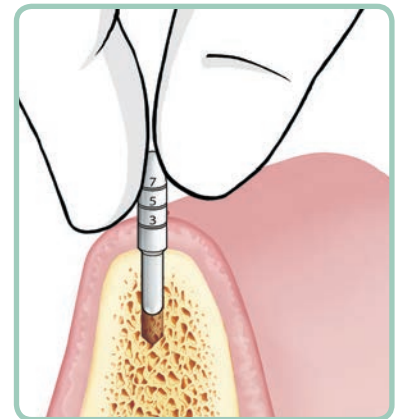

1.9b With flapless procedure, use of measuring pin for gingival height for the control of the mucosa height and parallelism with natural teeth and/or other adjacent implant sites. Measuring pins for gingival height present a hole for the placement of a safety leash.



1.10 Use of the depth gauge to check the depth of the newly-created implant site. The depth gauge presents a hole for the placement of a safety leash.

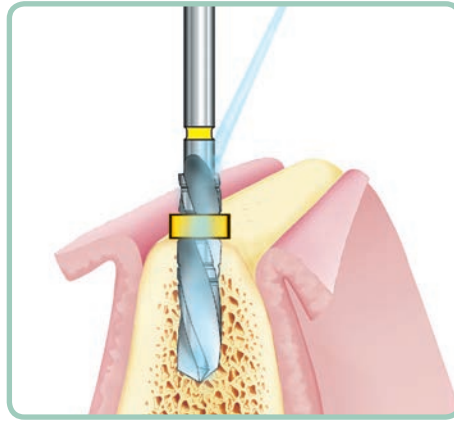

1.11 Widening of the diameter of the implant site with the progressive use of drills with increasing diameter. The drills have to be used up to the depth mark which corresponds to the length of the selected implant:

- for \varnothing 3.3 mm implants: use \varnothing 2.8 mm drill. Max speed: 600 rpm.
 - for \varnothing 4,1 mm implants: after \varnothing 2.8 mm drill, use the \varnothing 3,5 mm drill for the final resizing of the site. Max speed: 500 rpm.
 - for \varnothing 4,8 mm implants: after using \varnothing 2.8 mm and \varnothing 3.5 mm drills, use the \varnothing 4.2 mm drill for the final resizing of the site. Max speed: 400 rpm.
- Reminder: use adequate irrigation.

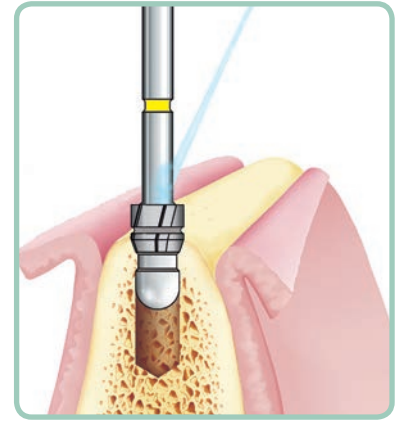

1.12 At the end of the widening operations of the implant site with the twist drills, the use of a countersink with the same diameter as the selected implant is recommended, by inserting it up to the reference mark. (Max speed: 300 rpm with adequate irrigation)

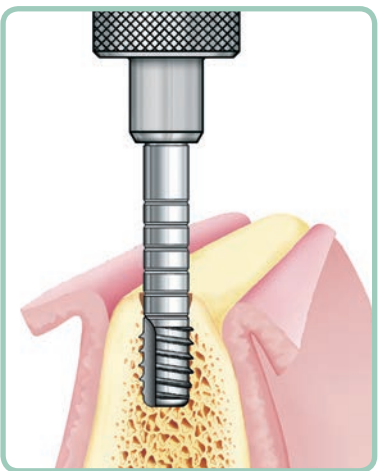

1.13 In case of high bone density, the use of the tap is recommended. With medium/low bone quality the **LEONE** implant is self-tapping.

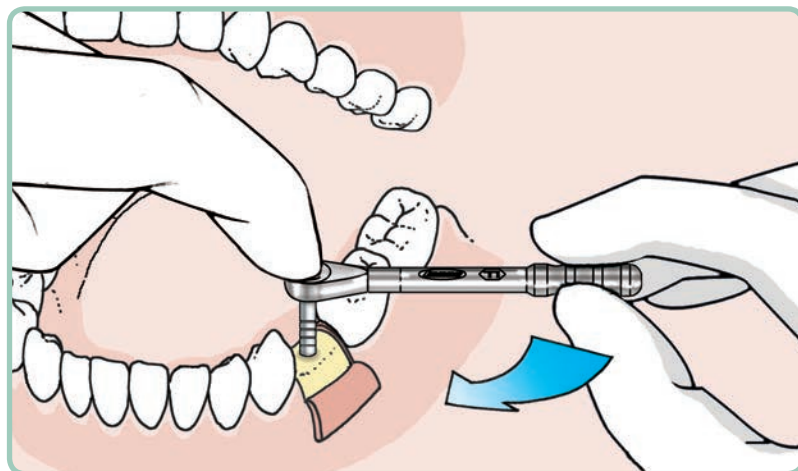

1.14 The tap can be connected either to the hand screwdriver or to the ratchet. When the space for the direct connection between the tap and the instruments is insufficient, the extension Cat. 156-1002-00 can be utilized. Tapping operations may be also performed by means of a handpiece for implantology connecting the tap to the special adapter Cat. 156-1002-01. Set the handpiece to a max speed value of 30 rpm and a max torque value of 50 Ncm.



2) LEONE IMPLANTS Ø 3,3 - 4,1 - 4,8: PLACEMENT OF THE IMPLANT

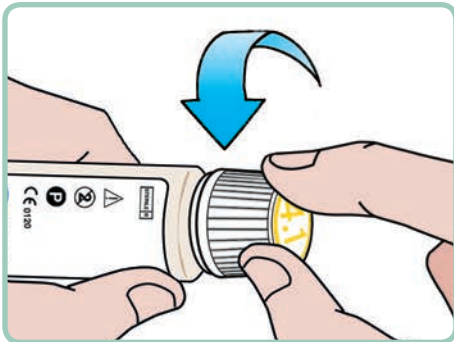

2.1 Unscrew the glass vial's top lid.

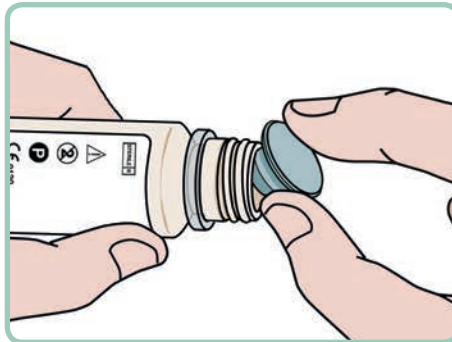

2.2 Remove the sealing cap.

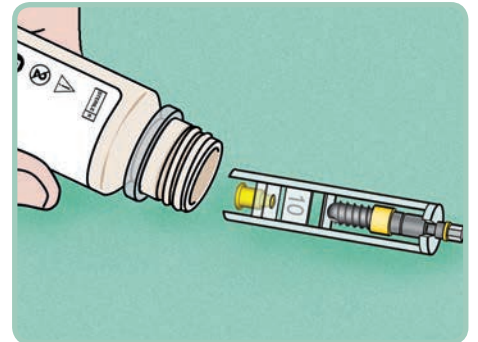

2.3 Extraction of the holder containing the implant and the cover cap on a sterile pad. The implant can be placed either with the handpiece or manually.

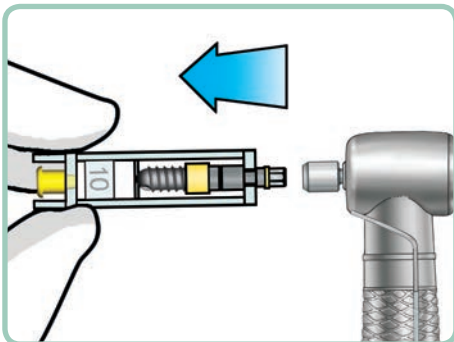

2.4a Connection of the handpiece adapter Cat. 156-1002-01 to the carrier of the implant. The use of the handpiece ensures the maintenance of the implant site axis.

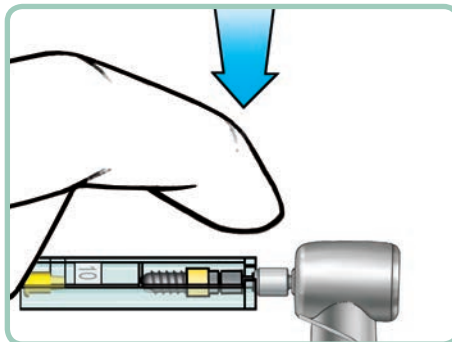

2.5a Extraction of the implant from the holder by exerting a pressure on the open side in order to detach the implant and make the holder fall down.

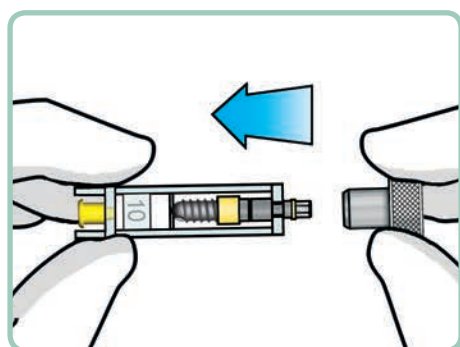
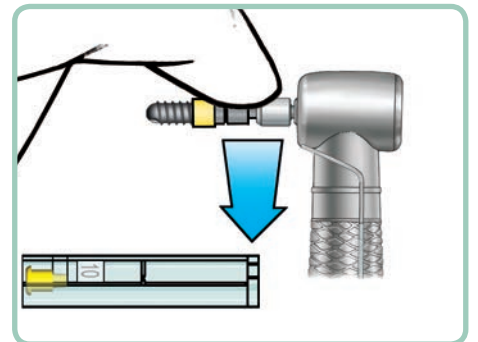

2.4b Connection of the hand screwdriver to the carrier of the implant. The hand screwdriver prevents a hole for the placement of a safety leash.

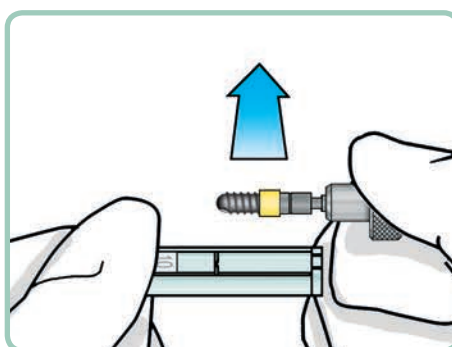

2.5b Extraction of the implant from the open side of the holder by means of the hand screwdriver. Take care to exert the extraction parallel to the longitudinal plan of the holder. A force applied in a different direction could cause difficulty in removing the carrier from the package and a possible contact with the surface of the implant.



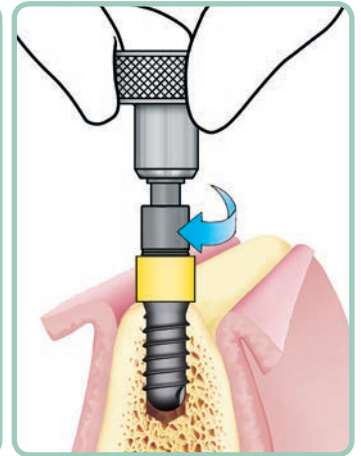
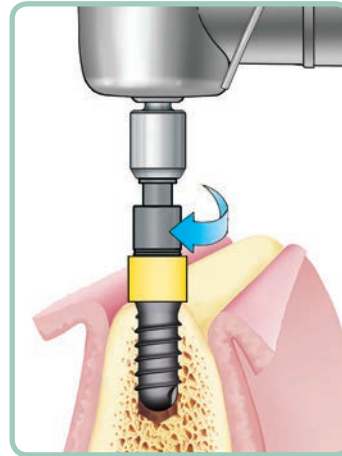
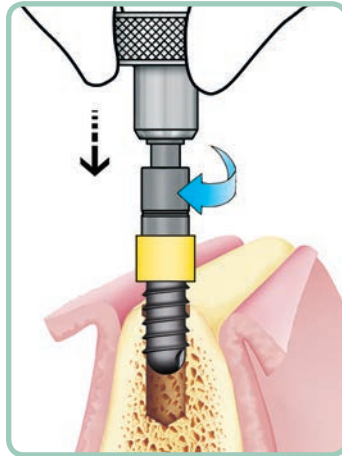
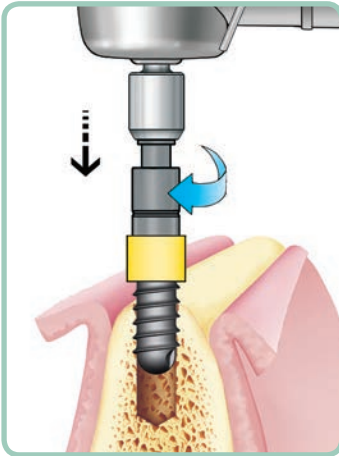

2.6 Initial seating of the implant into the implant site without irrigation. In case of using a handpiece, set a micromotor's maximum speed to 20 rpm and a maximum torque value to 50 Ncm. If there is not enough space for a direct connection between the carrier and the handpiece adapter or the hand screwdriver, the extension Cat. 156-1002-00 may be used.

2.7 While driving the implant into the implant site, the rubber ring slides up along the carrier.

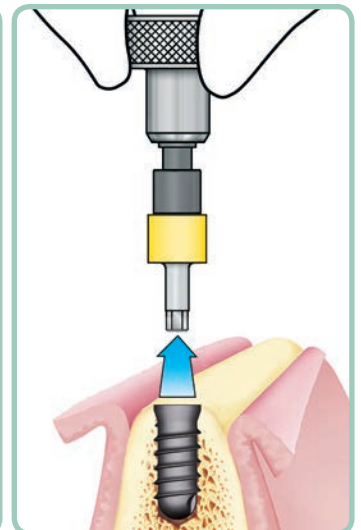
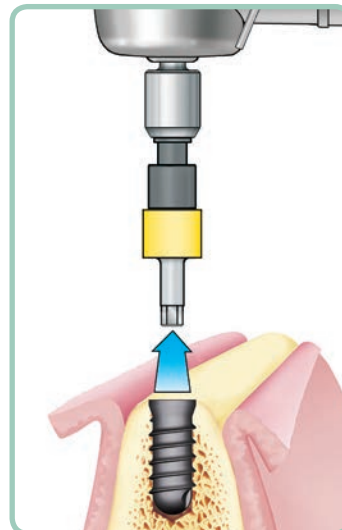
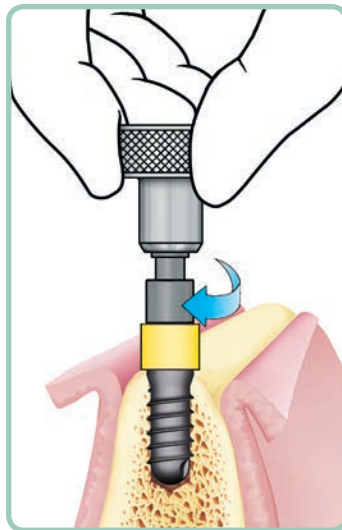
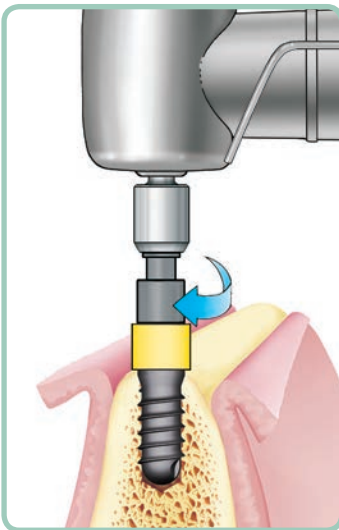

2.8 When the carrier's rubber ring has reached the reference line, the implant is exactly positioned at the level of the alveolar crest. Now the carrier can be easily disconnected from the implant.

2.9 Removal of the carrier from the implant.

2.10 Rinsing and drying of the implant's inner side before placing the cap.

At this stage, either a "Two-stage surgical procedure" or a "One-stage surgical procedure" may be followed.

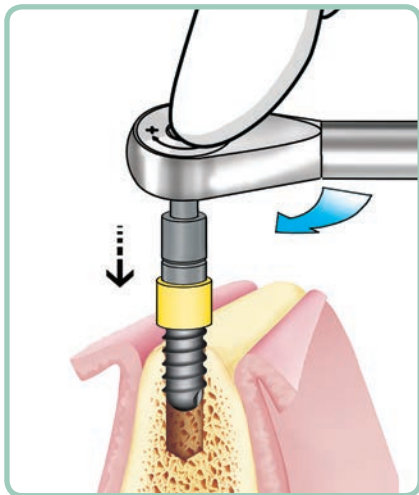

2.11 Should a ratchet be utilized, the forces exerted on the implant and on the correspondent periimplant bone can become excessive.

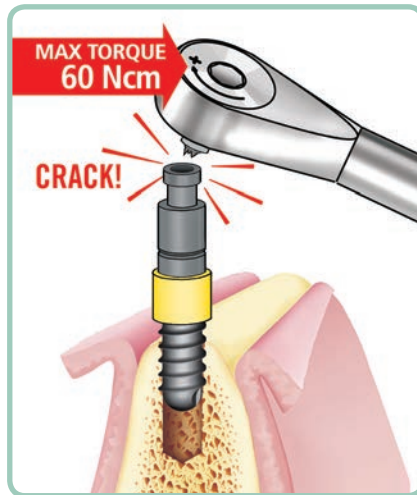

2.12 In this eventuality, should a value of 60 Ncm be overcome, a torque limiting device makes the carrier break above the connection with the implant; now the carrier can be removed.

Note that carrier fracture is not always visible, but it is detectable by a sudden loss of functionality of the insertion instrument accompanied by a sharp crack.

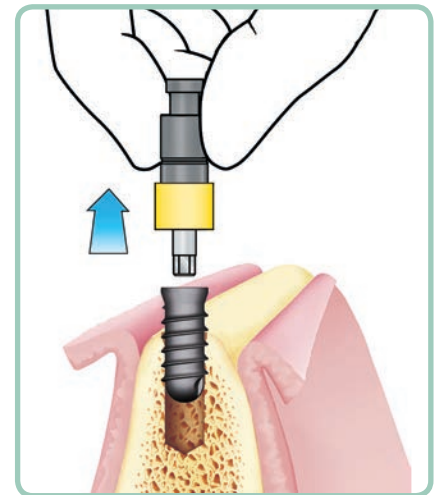

2.13 Removal of the fractured carrier.

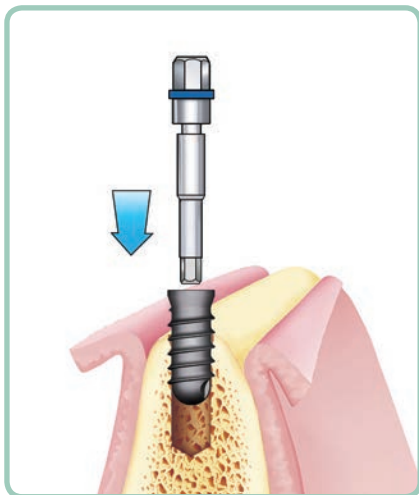

2.14a Replace the carrier with the driver for implant (Cat. 156-1013-00 available either in the surgical kit or in the organizer for instruments) withstanding up to a torque applied of 140 Ncm and allowing the removal of the implant.

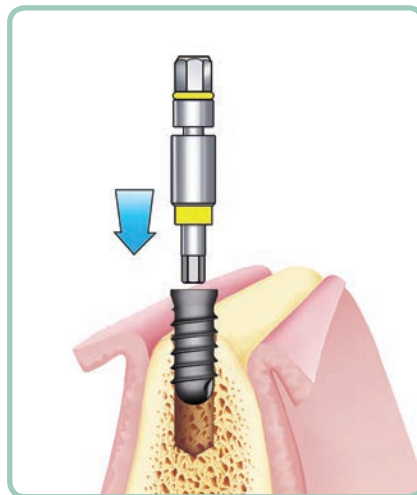

2.14b It is possible to use special drivers specific for each connection size, which are more stable thanks to the conical support ring and thus more resistant to the application of bending forces.

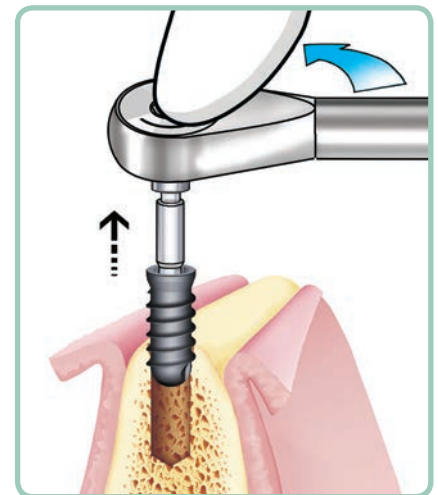

2.15 Removal of the implant from the implant site.
Tapping and reinsertion of the implant.

3) LEONE 6.5 SHORT IMPLANT: PREPARATION OF THE IMPLANT SITE

The **LEONE 6.5** short implant is intended for use in cases with limited vertical bone availability. The typology and the access to the surgical site shall be selected by the professional according to the clinical-morphological parameters. Schematically and with illustrative purpose only, the following steps for the preparation of the implant site are illustrated.

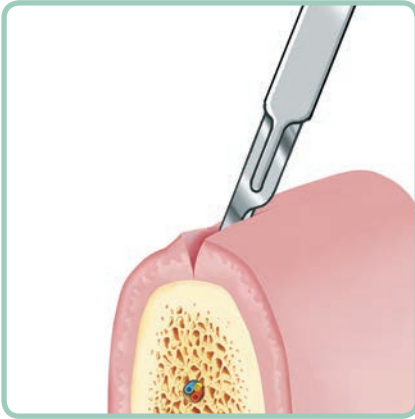

3.1 Full-thickness incision of the soft tissues and detachment of the gingival flaps to have access to the bone ridge.

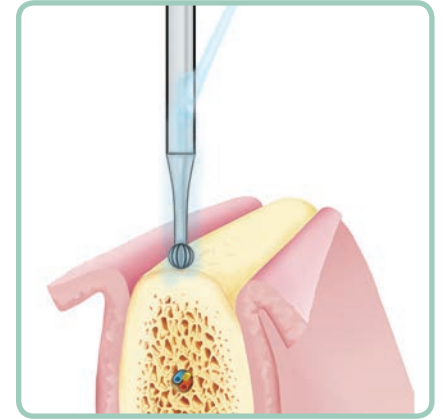
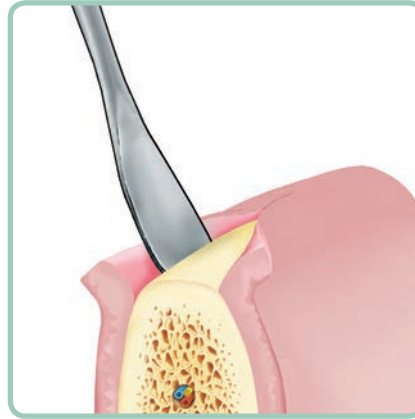

3.2 Use of the round bur Cat. 151-1934-01 to mark the cortical bone for the subsequent drills. Alternatively, it is possible to use the lance drill Cat. 151-1930-02, which is particularly suitable in case of narrow knife-edged ridges.

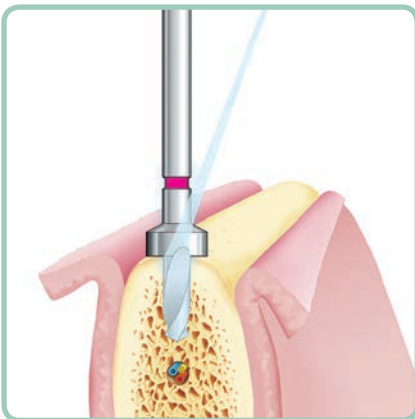

3.3 Use of the \varnothing 2,2 mm pilot drill with integrated stop, Cat. 151-2233-65: insert the drill up to the stop. (Max speed: 800 rpm with adequate irrigation).

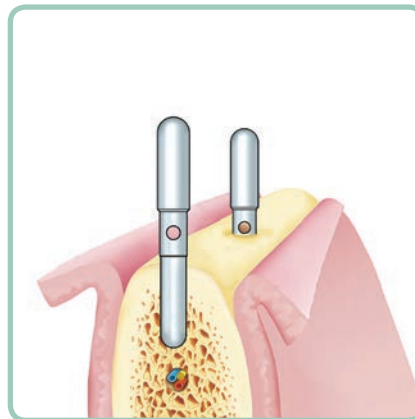

3.4 Use of paralleling pins as an aid for proper alignment with natural teeth and/or other adjacent implant sites. A radiographic exam can be performed to increase accuracy in the evaluation of parallelism. The paralleling pin can also be utilized after the application of a \varnothing 2.8 mm twist drill with integrated stop, Cat. 151-2833-65, taking care to seat the pin in the implant site from the side with the larger diameter. Paralleling pins present a hole for the placement of a safety leash.

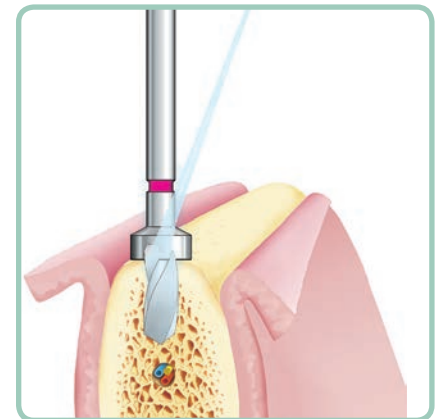

3.5 Use of the \varnothing 2,8 mm twist drill with integrated stop, Cat. 151-2833-65: insert the drill up to the stop. (Max speed: 600 rpm with adequate irrigation).

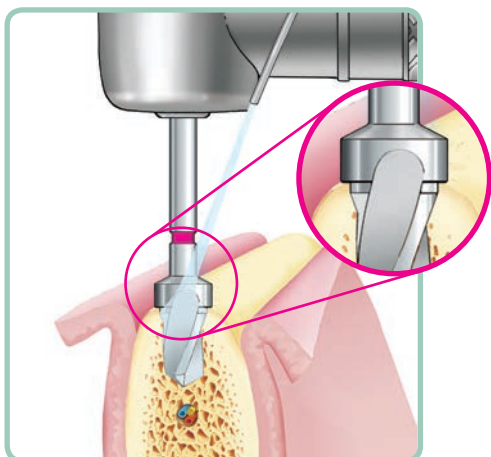

3.6 Use of the \varnothing 3.5 mm twist drill with integrated stop and crestal countersink, Cat. 151-3533-65: insert the drill up to the stop, (Max speed 500 rpm with adequate irrigation).

The drill's geometry allows also the shaping of the conical region of the implant bed.

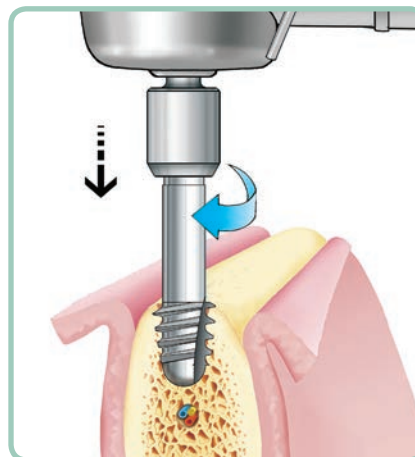

3.7a Use of the bone tap "A" Cat. 152-5021-01 in combination with the specific handpiece adapter Cat.156-1002-01: attach the tap to the handpiece, then tap the implant site until the tap's threaded portion is totally inside the bone; the use of the handpiece ensures the maintenance of the implant site axis.

Set a micromotor's maximum speed of 30 rpm and a maximum torque value of 50 Ncm.

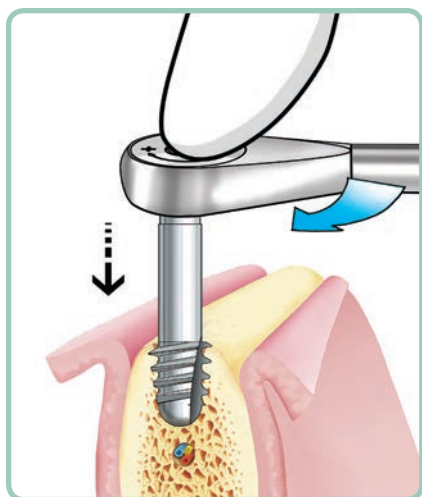

3.7b If the maximum torque value of 50 Ncm is not enough to complete the tapping operation, remove the handpiece adapter from the bone tap and attach the ratchet Cat.156-1014-00. Complete the tapping operation until the tap's threaded portion is totally inside the bone.

If the space for a direct connection between the bone tap and the instruments is not enough, the extension Cat. 156-1002-00 may be used.

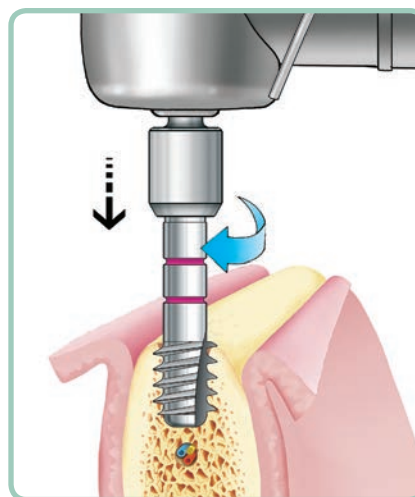

3.8 In case of high bone density, the bone tap "B" Cat. 152-5021-02 has to be necessarily used **after tapping with bone tap "A"**: steps 3.7a and 3.7b. shall be repeated.

The bone tap "B" can easily be distinguished from bone tap "A" by two fuchsia-coded marks on the instrument.

4) LEONE 6.5 SHORT IMPLANT: PLACEMENT OF THE IMPLANT

For the extraction of the implant holder from the **LEONE 6.5** short implant package, follow the instructions illustrated at points 2.1-2.2-2.3:

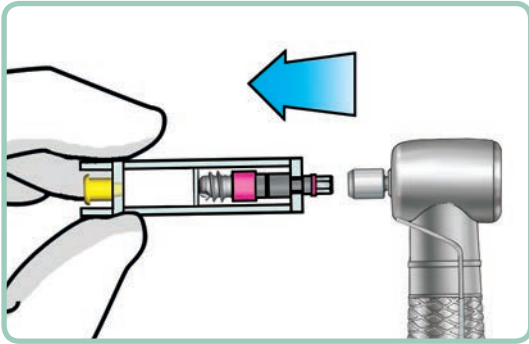

4.1 Connection of the handpiece adapter to the carrier of the implant; the use of the handpiece ensures the maintenance of the implant site axis.

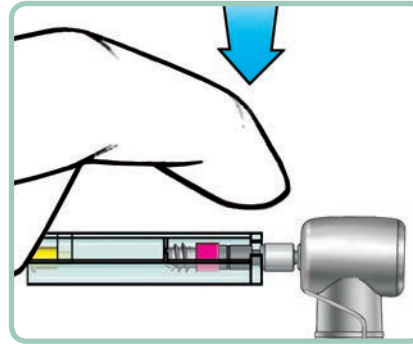

4.2 Extraction of the implant from the holder by exerting a pressure on the open side in order to detach the implant and make the holder fall down.

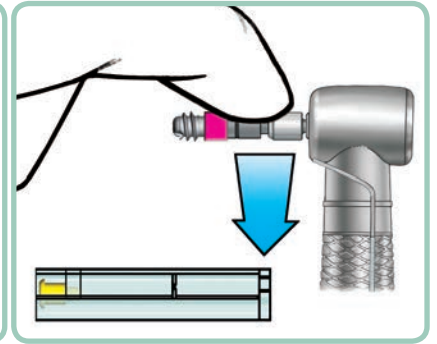

4.3 Initial seating of the implant in the implant site. If there is not enough space for a direct connection between the carrier and the handpiece adapter, the extension Cat. 156-1002-00 may be used.

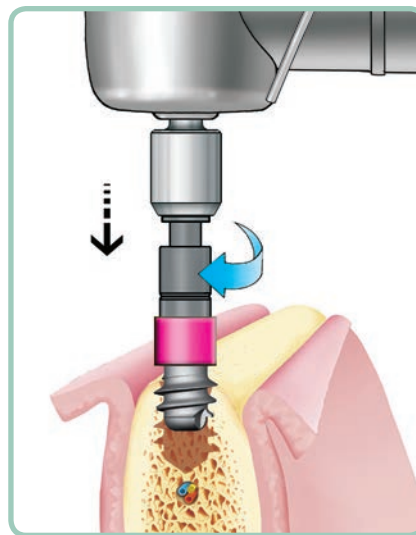

4.4 Seating of the implant with a micromotor for implants. Set a micromotor's maximum speed of 20 rpm and a maximum torque value of 50 Ncm. Do not irrigate while placing the implant.

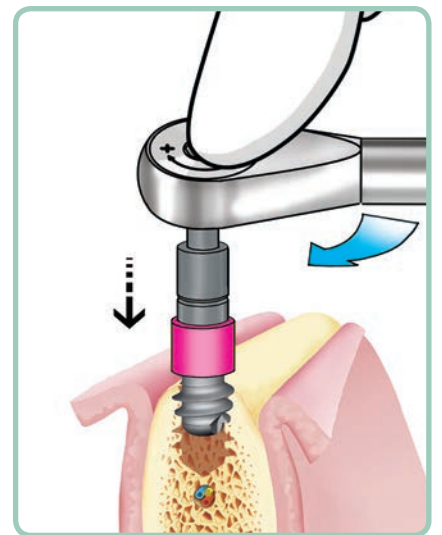

4.5 If the maximum torque value of 50 Ncm is not enough to complete the insertion of the implant, remove the handpiece adapter from the carrier and attach the ratchet Cat.156-1014-00. Be sure the instrument is directed in the long axis by gentle pressing the head of the instrument with a finger.

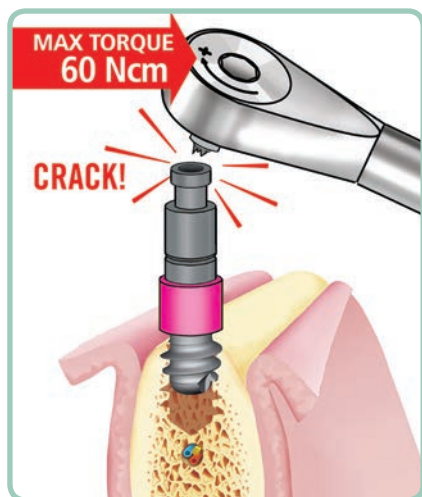

4.6 When using a ratchet, the forces exerted on the implant and on the correspondent periimplant bone can become excessive. In this eventuality, should the value of 60 Ncm be overcome, a torque limiting device makes the carrier break above the connection with the implant; now the carrier can be removed. Note that carrier fracture is not always visible, but it is detectable by a sudden loss of functionality of the insertion instrument accompanied by a sharp crack.

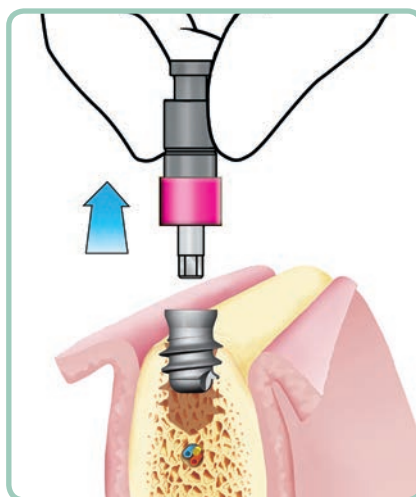

4.7 Removal of the fractured carrier.

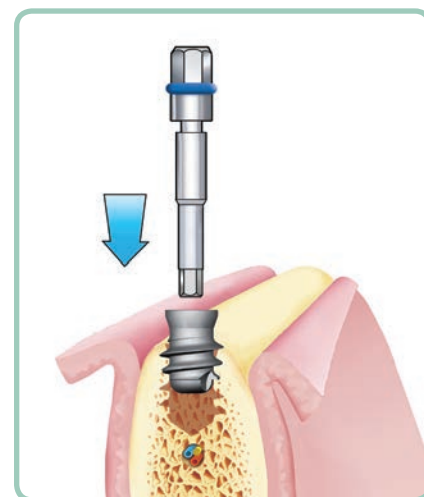

4.8 Replace it with the implant driver Cat. 156-1013-00 available either in the surgical kit or in the organizer Cat. 156-0019-00. It withstands a torque value applied up to 140 Ncm and allows the removal of the implant. It is possible to use the implant driver Cat. 156-1041-00, which is more stable thanks to the conical support ring and thus more resistant to the application of bending forces.

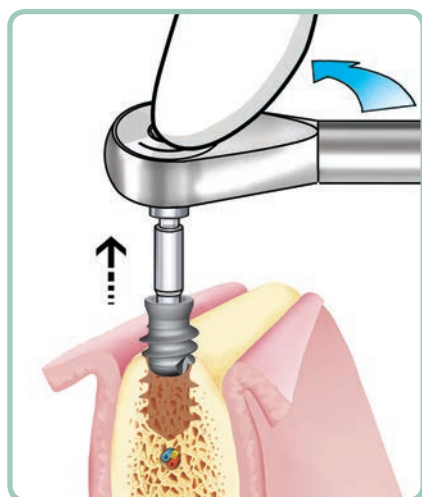

4.9 Attach the ratchet to the driver and remove the implant from the implant site. Tapping of the site with bone tap "B".

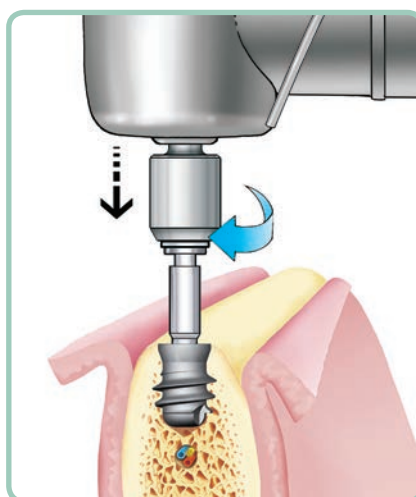

4.10 Place again the implant by means of the implant micromotor with the driver attached to the handpiece adapter. Set a micromotor's maximum speed of 20 rpm and a maximum torque value of 50 Ncm. If the maximum torque pre-set value is not enough to complete the insertion of the implant, remove the hand piece adapter from the driver and attach the ratchet.

4.11 Rinsing and drying of the implant's inner side before placing the cover cap.

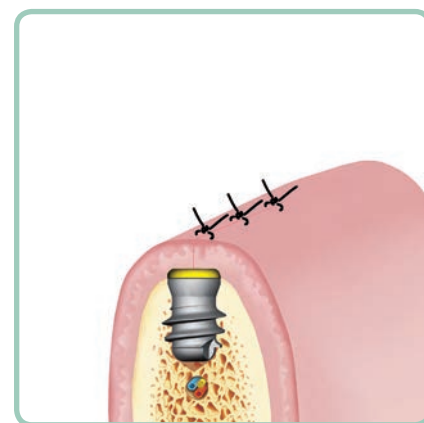

4.12 In order to complete the placement of the implant, follow the steps for "Two stage surgical procedure" (see point 5 "Two stage surgical procedure: first stage") and instructions at points 6, 7 or 8 for the conditioning of soft tissues.

5) TWO-STAGE SURGICAL PROCEDURE: FIRST STAGE

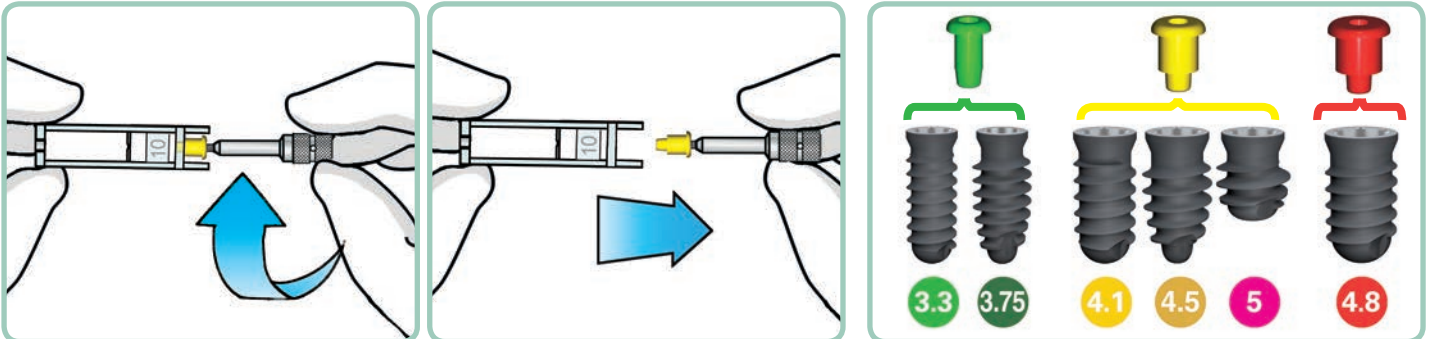

5.1 Take the holder that previously contained the implant. Screw the instrument for cover caps, Cat. 156-1003-00, onto the head of the cover cap. Do not screw the instrument all the way in, but only half way the length of the threaded part. The instrument for cover cap presents a hole for the insertion of a safety leash. Removal of the biopolymer sealing cap from the holder by exerting a gentle extraction.

5.2 In case of positioning of several implants, the colour of the cover cap allows an immediate recognition of the correct connection size for the subsequent prosthesis component.

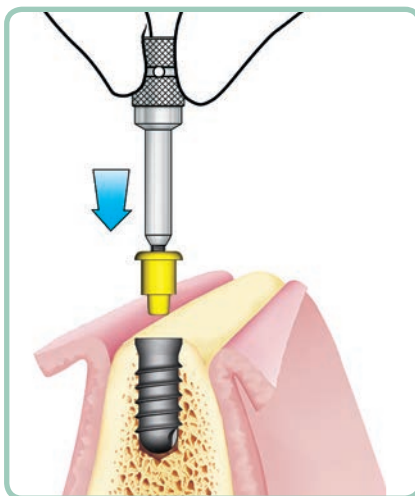

5.3 Rinsing and drying of the implant's inner side. Positioning of the cover cap on the implant: push the cap home inside the implant.

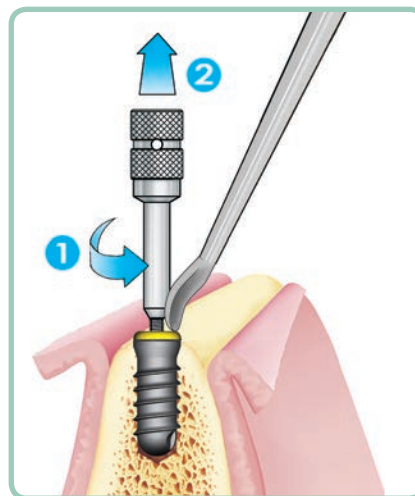

5.4 Removal of the instrument for cover cap by unscrewing in an anti-clockwise direction while holding the cover cap in place with an instrument. Push now the cover cap inside to its final position with a non sharp tool to get a perfect sealing of the implant.

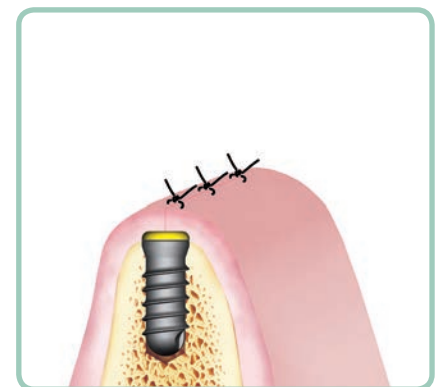

5.5 The gingival flaps are sutured for total coverage of the implant.

The average period for the attainment of a good osseointegration, which is facilitated by the HRS surface that covers all LEONE implants, is about 3 months. This period may however vary up to 8 months depending on the type of surgical intervention, the quality of the bone and the individual patient response. Clinical check-ups and instrumental exams are absolutely necessary.

6) TWO-STAGE SURGICAL PROCEDURE: SECOND STAGE

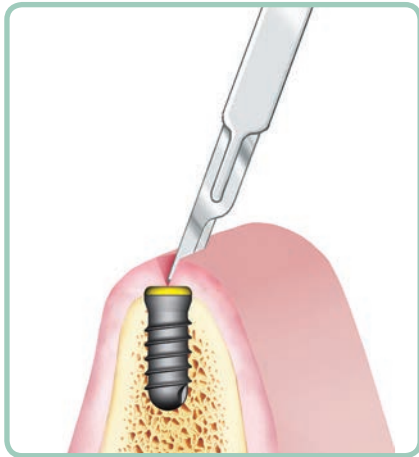

6.1 Once osseointegration has occurred, the position of the implant is identified and an incision of the soft tissue covering the implant is performed.

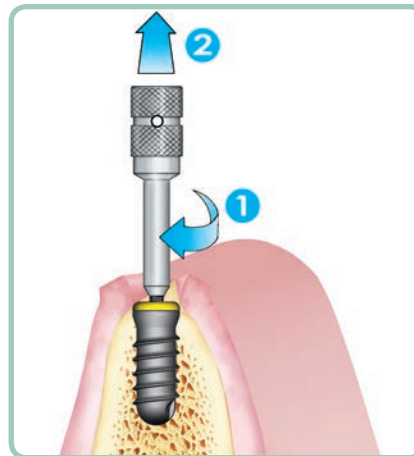

6.2 Removal of the cover cap with the specific instrument Cat. 156-1003-00 that is supplied either in the surgical kit or in the instrument organizer. The instrument for cover cap has to be screwed into the head of the cover cap to be able to practice enough traction to remove the cap.

6.3 Accurate rinsing and drying of the implant's inner part.

Follow the steps described at chapters 7 or 8 according to the selected platform.



7) TWO-STAGE SURGICAL PROCEDURE: CONDITIONING OF THE SOFT TISSUES FOR STANDARD AND LARGE PLATFORM

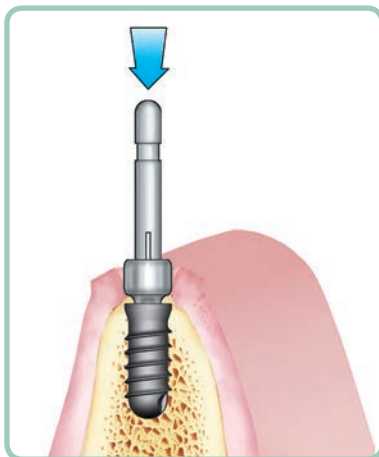
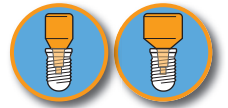

7.1 Place the appropriate healing cap (supplied sterile) onto the implant by means of the carrier. Exert a pressure on the carrier.

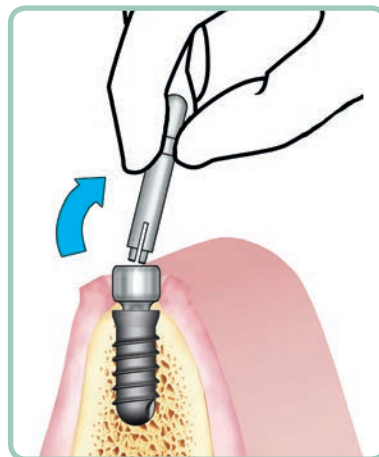

7.2 Removal of the carrier with a gentle side bending and pull.

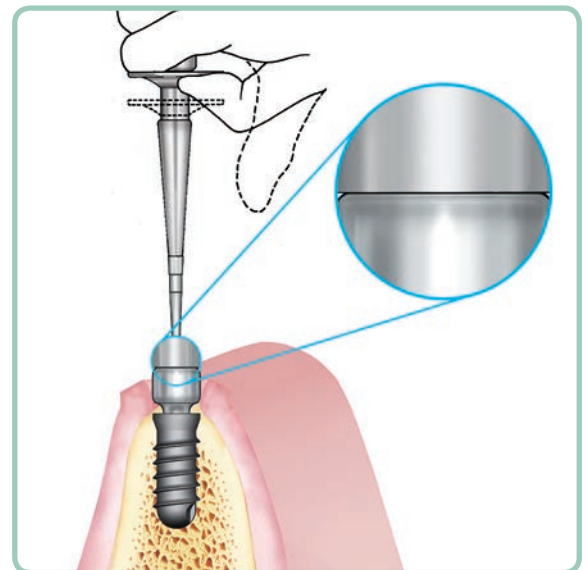

7.3 Percussion on the healing cap by means of the specific beater (page 38) to activate the locking-taper connection. One percussion is advisable.

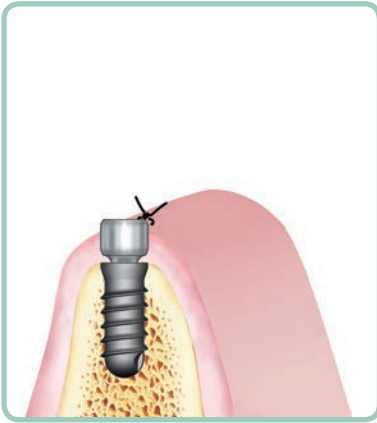

7.4 Suture of the soft tissues around the healing cap.

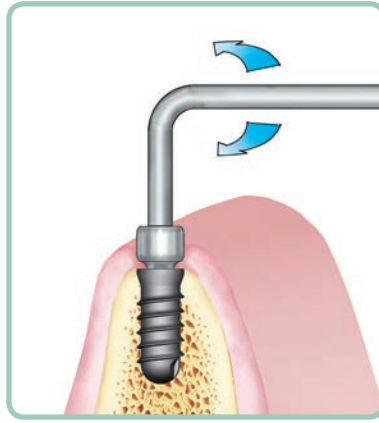

7.5 When the healing process has occurred, the healing cap is unlocked by means of the specific hex-head extractor, Cat. 156-1006-00. The extractor, with a hole for the placement of a safety leash, is seated into the hexagon on the head of the healing cap and rotated subsequently, either clockwise or anti-clockwise, in order to unlock the healing cap. By using tweezers, the cap is removed from the implant. The implant is now ready for the prosthetic phase.

*For the impression taking, the preparation of the abutment and the fabrication of the final prosthesis, refer to the “Prosthetic Procedure of the **LEONE** Implant System”.*



**8) TWO-STAGE SURGICAL PROCEDURE:
CONDITIONING OF THE SOFT TISSUES FOR SLIM PLATFORM**

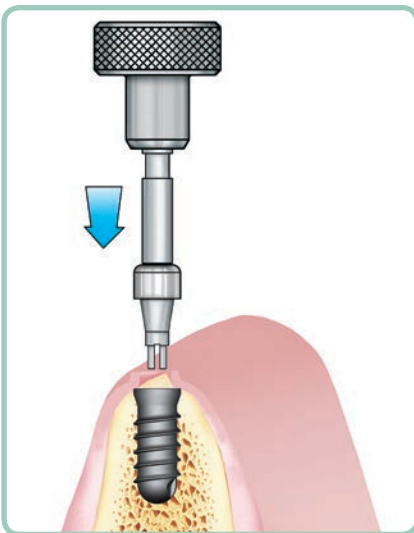

8.1 Positioning of the healing cap (supplied sterile) on the implant by means of the special carrier eventually connected to a hand screwdriver to facilitate its taking. When its hexagonal shape is engaged, exert a pressure on the healing cap to get a perfect closure of the implant.

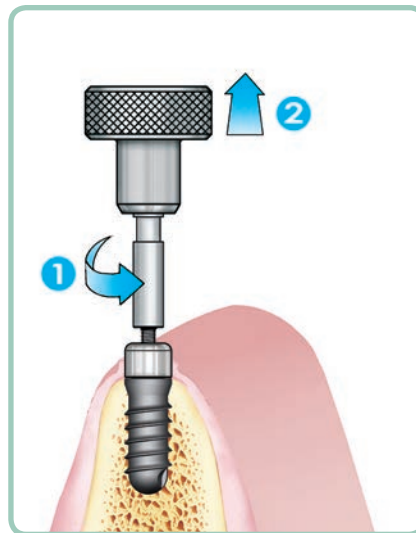

8.2 Removal of the carrier by unscrewing in an anti-clockwise direction. The operation can be facilitated by connecting the carrier to a hand screwdriver.

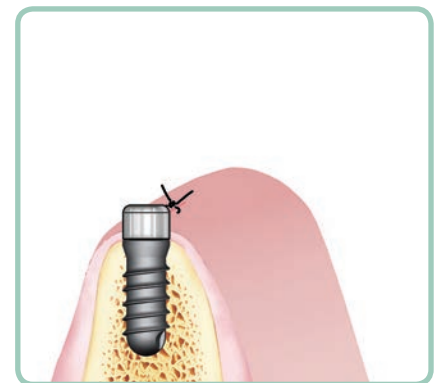

8.3 The soft tissues are sutured around the healing cap.

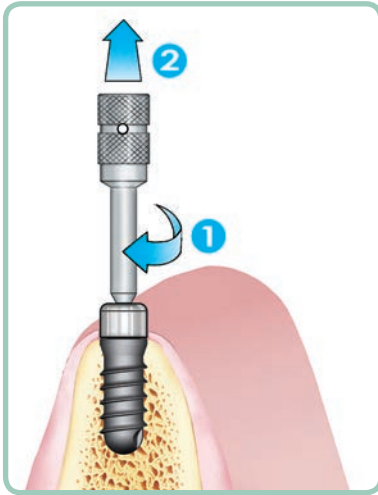

8.4 When the healing process has occurred, the healing cap is removed by means of the instrument for cover cap Cat. 156-1003-00 which is provided in the surgical kit or in the organizer for instruments. The instrument for cover cap has to be screwed into the head of the healing cap to be able to practice enough traction to remove the cap.

For the impression taking, the preparation of the abutment and the fabrication of the final prosthesis, refer to the "Prosthetic Procedure of the LEONE Implant System".



9) ONE-STAGE SURGICAL PROCEDURE FOR STANDARD AND LARGE PLATFORM



For previous steps refer to chapters 1) and 2).

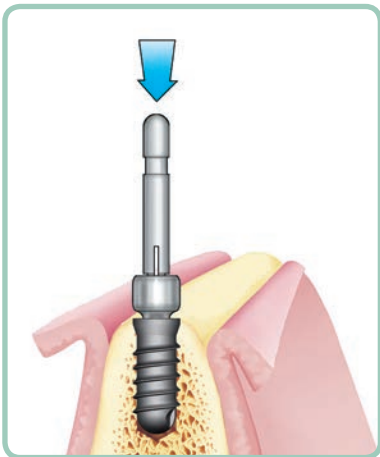

9.1 Rinsing and drying of the implant's inner side.

Sealing of the implant with the healing cap (supplied sterile) by means of the carrier. Exert a pressure on the carrier. In case of flapless procedure and subcrestal implant placement, do not use Large healing caps.

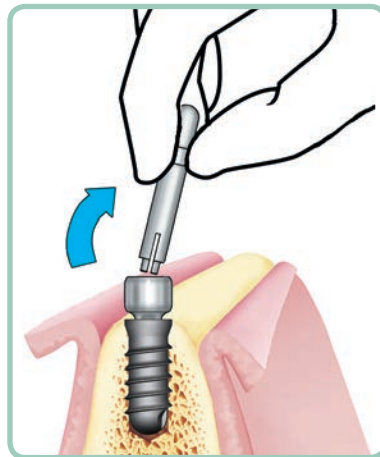

9.2 Removal of the carrier with a gentle side bending and pull.

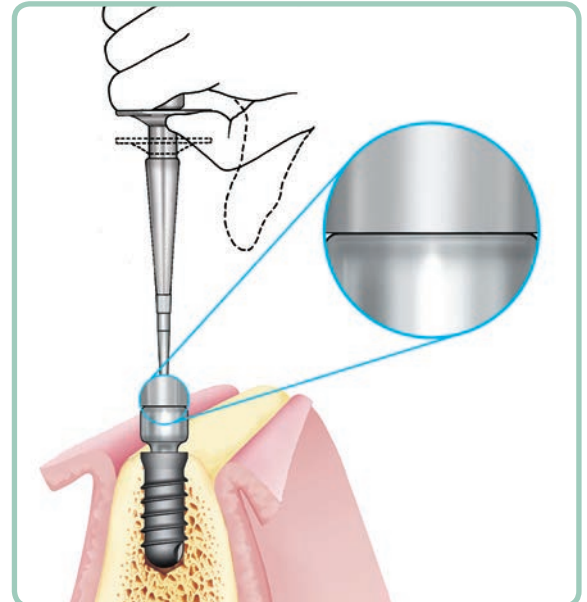

9.3 Percussion on the healing cap by means of the specific beater to activate the locking-taper connection. One percussion is advisable.

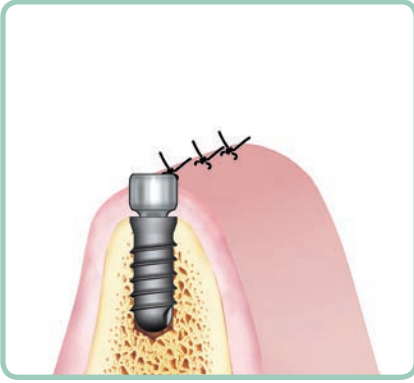

9.4 Suture of the soft tissues around the healing cap.

*The average period for the attainment of a good osseointegration, which is facilitated by the HRS surface that covers all **LEONE** implants, is about 3 months. This period may however vary up to 8 months depending on the type of surgical intervention, the quality of the bone and the individual patient response. Clinical check-ups and instrumental exams are absolutely necessary.*

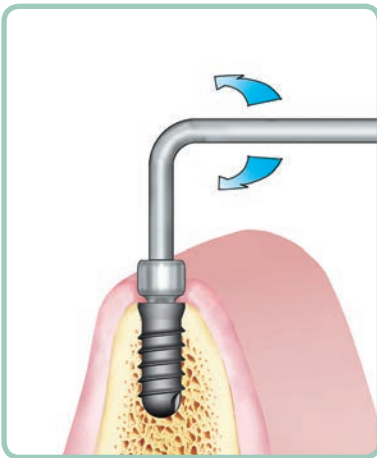

9.5 When osseointegration has occurred unlock the healing cap by means of the specific hex head extractor Cat. 156-1006-00. The extractor is seated into the hexagon which is present on the head of the healing cap and rotated either clockwise or anti-clockwise, in order to unlock the healing cap. The extractor presents a hole for the placement of a safety leash. The cap is removed from the implant with the use of tweezers. The implant is now ready for the prosthetic procedure.

*For the impression taking, the preparation of the abutment and the fabrication of the final prosthesis, refer to the “Prosthetic Procedure of the **LEONE** Implant System”*

10) LOW SELF-LOCKING CAPS: INSTRUCTIONS FOR USE AND PROCEDURE

Premise

The low self-locking caps shall be used:

- a) during the two-stage (see point 5) surgical technique in place of the cover caps in case of post-extraction or subcrestal positioning of the implant
- b) during either the two-stage (see point 7) or one-stage (see point 9) surgical technique in place of the healing caps in case of low gingival thickness.

a) USE IN PLACE OF COVER CAPS



10.1a First surgical stage: the implant is seated below the alveolar crest level.

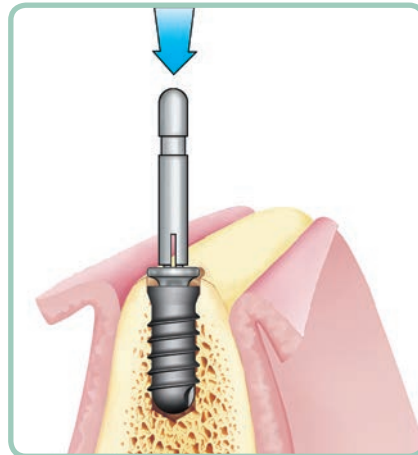

10.2a Positioning of the low self-locking cap (supplied sterile) on the implant with the carrier. Follow steps 7.2 and 7.3 to activate the locking-taper connection.

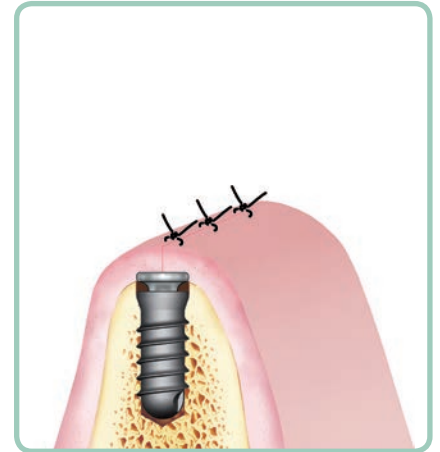

10.3a The gingival flaps are sutured for total coverage of the implant. When osseointegration has occurred, after flap re-opening follow steps 10.4b and 10.5b.

b) USE IN PLACE OF HEALING CAPS

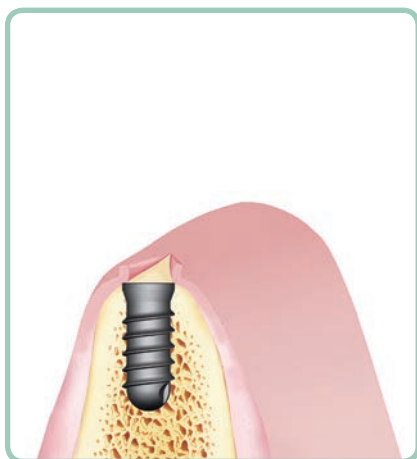

10.1b The implant is at the alveolar crest level. Rinsing and drying of the implant's inner side.

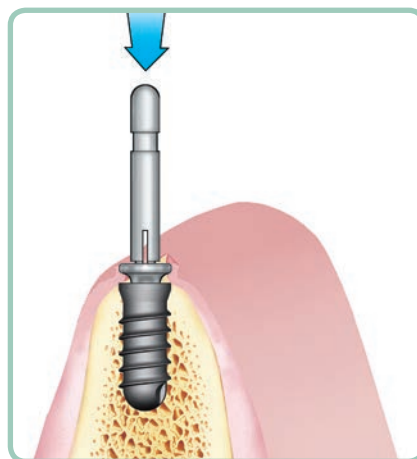

10.2b Positioning of the low self-locking cap (supplied sterile) on the implant with the carrier.

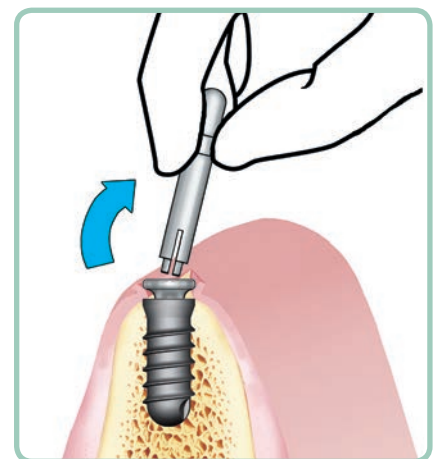

10.3b Removal of the carrier with a gentle side bending and pull. Follow steps 7.3 and 7.4 to activate the locking-taper connection and to suture the soft tissues.

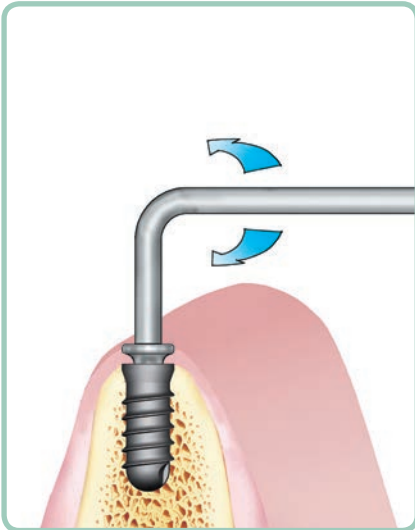

10.4b When osseointegration and healing of the soft tissues have occurred, unlock the low self-locking cap by means of the specific hex head extractor Cat. 156-1006-00. The extractor is seated into the hexagon which is present on the head of the cap and rotated either into a clockwise or anti-clockwise direction.

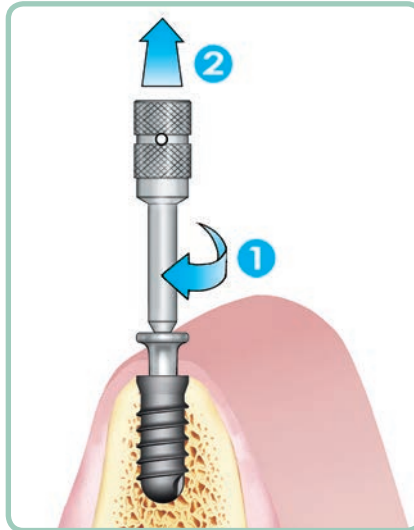

10.5b Screw the instrument for cover caps, Cat. 156-1003-00, onto the head of the low self-locking cap. Remove the cap with a gentle pull. Now the implant is ready for the prosthetic stage.

For the impression taking, the preparation of the abutment and the fabrication of the final prosthesis, refer to the "Prosthetic Procedure of the LEONE Implant System".

11) OVERDENTURE: TWO-STAGE SURGICAL PROCEDURE FOR STANDARD PLATFORM

Premise

Abutments for attachment-retained overdenture (O-ring or insert) and for bar-retained overdenture are available. In order to manufacture an overdenture, a perfect parallelism among the implants is necessary. To support an overdenture in the lower jaw a minimum of 2 implants is required and in the upper jaw a minimum of 4 implants. The two-stage surgical procedure, as described at steps 5), 6) and 7), is recommended.

It is possible to fabricate an overdenture with a new or a pre-existing prosthesis, the second case must be evaluated by the clinician.

The herewith graphical illustrations refer to the placement of two implants in the mandible.

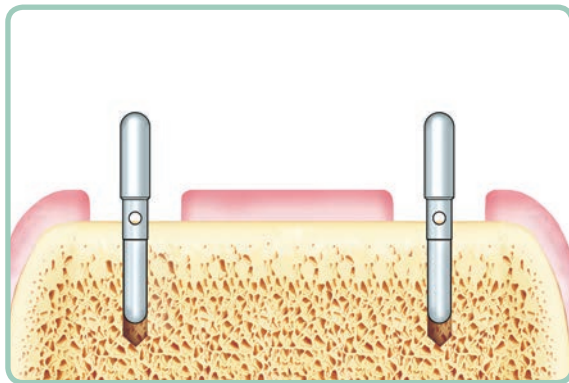

11.1 Preparation of the implant sites, with a special care for parallelism.

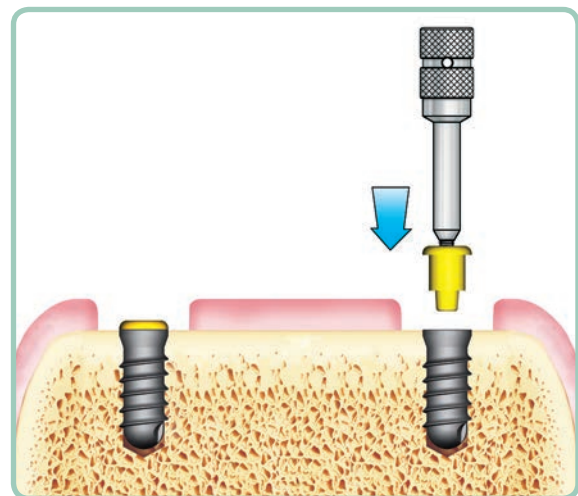

11.2 Placement of the implants and cover caps.

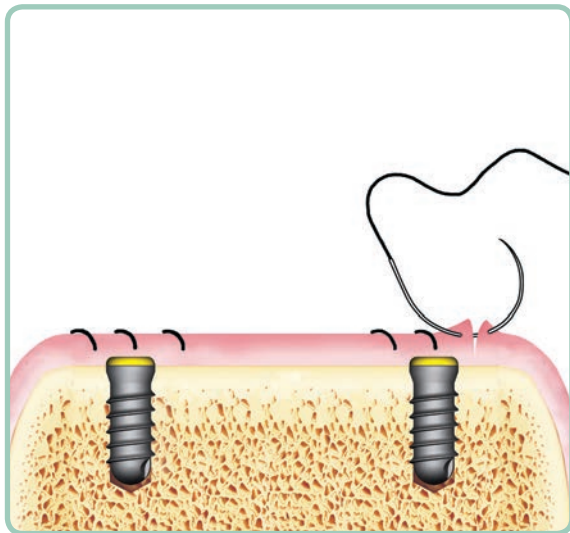

11.3 The gingival flaps are sutured for total coverage of the implants. It is recommended to wait several days before using a temporary prosthesis or the pre-existing prosthesis of the patient. The resin of the prosthesis, however, must be removed in the area of the implants and rebased with soft resin.

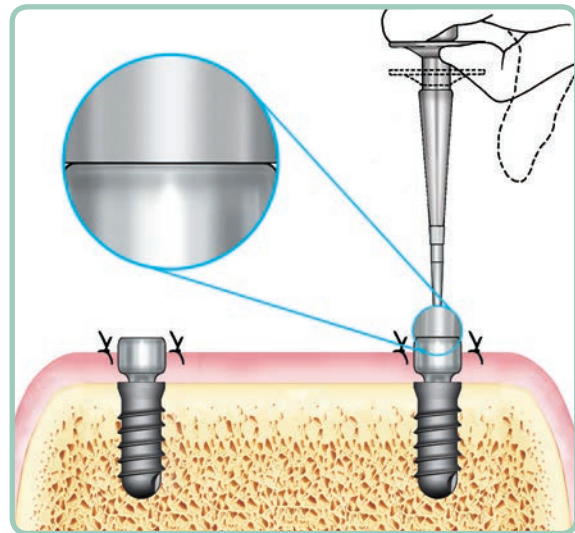

11.4 After the attainment of a good osseointegration of the implants, the implants are exposed and the cover caps are removed.

11.5 Placement of the Standard healing caps for the conditioning of the soft tissues. One percussion is advisable.

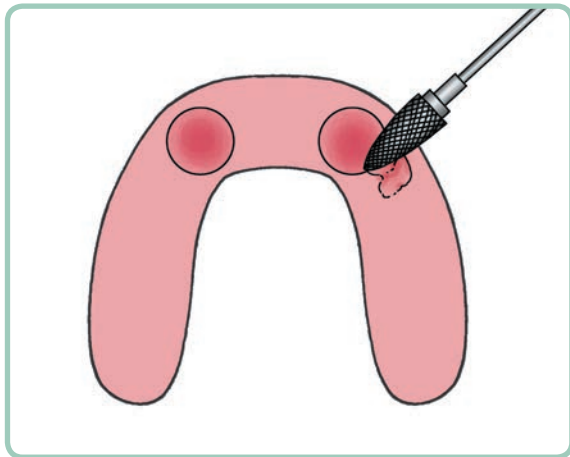

11.6 Adjustment of the temporary or pre-existing prosthesis with removal of the acrylic in the areas corresponding to the healing caps.

11.7 After the healing of the soft tissues, the final overdenture is fabricated.

*For the fabrication of the final prosthesis, refer to the "Prosthetic Procedure of the **LEONE** Implant System".*

LEONE MAX STABILITY IMPLANT SURGICAL PROCEDURE

Please consult *Disclaimer, Treatment planning and preoperative exams* (page 52).

MAX STABILITY IMPLANT SELECTION

Max Stability implants are indicated for use in cases of poor bone density or when performing immediate implant placement.

Do NOT use Max Stability Implants in thick cortical bone, equivalent to D1 bone density according to the Misch Classification.^[1]

The number and dimensions (diameter and length) of the implants to be seated are determined by the following factors:

1. amount of bone available
2. characteristics of the implant site
3. masticatory load
4. aesthetic results
5. type of the prosthetic restoration
6. type of the surgical procedure followed

Further and particular single situations must be evaluated by the clinician.

A template, Cat 156-2003-04, is available showing **Max Stability** implants in actual dimensions, with dimensions increased by 10% and increased by 25%, to match possible distortions created by the instrument for radiographic examinations (CT, panoramic radiograph, standard and digital cephalograms).

Superimpose the template to the radiograph in order to select the implant in relation to the quantity of bone available.

*Do not insert a single **Max Stability** Ø3.75 mm implant in the molar position.*

*The **Max Stability** Ø3.75 mm implant, 8 mm in length, must be used as a supplementary implant in the prosthesis composed of two or more implants of any diameter and length.*

Do not place the implants above the level of the alveolar crest.

The **LEONE** implant system is characterized by a high mechanical resistance validated through fatigue strength testing according to the ISO 14801 international standard, which indicates to perform testing with a cyclic loading at an angle of 30° with respect to the implant-abutment axis. For the **LEONE** implants of minor diameter, and thus the most relevant ones, the results are: Ø3,3 mm and Ø3,75 mm implant fatigue strength: 240 N; Ø4,1 mm, Ø4,5 mm and **LEONE 6.5** short implant fatigue strength: 392 N.^[2,3]

In the literature, in comparison, it is reported that the average force generated during mastication is 145 N with inclinations up to 10°.^[4,5] It should also be underlined that very high masticatory forces^[6] can be generated due to many individual and prosthetic factors, such as crown height, cantilever and restoration type, which locally can exceed the strength limit of the implants, especially in case of single or unsplinted implants.

ORGANIZER FOR LEONE MAX STABILITY IMPLANTS

Organizers are available for sterilizing and clearly arranging all the instruments necessary for the planned surgical intervention.

The organizer is fully autoclavable and can hold up to 8 instruments using a colour coded positioning system.

The organizer must be wrapped and sterilized before every use.

The sterilization must be done as follows:

- wrap the organizer into a sterilization bag as requested by the manufacturer of the sterilizing machine;
- autoclave at 121° (250°F) for 20 minutes;
- remove the organizer from the autoclave and leave it cool inside the bag;
- leave the organizer inside the bag to preserve sterility.

^[1] Misch CE, Density of bone: effect on treatment plans, surgical approach, healing and progressive bone loading, Int J Oral Implant 1990; 6:23-31

^[2] ISO 14801:2007 (E), Dentistry - Implants - Dynamic fatigue test for endosseous dental implants, International Organization for Standardization, Geneva, 2007

^[3] Barlatzani A, Sannino G, Mechanical evaluation of an implant-abutment self-locking taper connection: finite element analysis and experimental tests, Int J Oral Maxillofac Implants 2013; 28:e17-e26

^[4] Carlsson GE, Haraldson T. Functional response. In: Branemark P-1, Zarb GA, Albrektsson T. Eds. Tissue integrated prostheses. Osseointegration in clinical dentistry. Chicago: Quintessence, 1985:155-63

^[5] Graf H. Occlusal forces during function. In: Proceedings of Symposium on Occlusion: Research on Form and Function. University of Michigan School of Dentistry, Ann Arbor: Rowe NH (Ed.), 1975:90-111

^[6] Craig PG. Restorative dental material. 6th ed. St. Louis, C.V. Mosby, 1980



1) LEONE MAX STABILITY IMPLANTS Ø3,75 - 4,5: PREPARATION OF THE IMPLANT SITE

Max Stability implants feature an innovative design developed to increase primary stability in cases where the implant site does not offer adequate initial stability. In particular, these implants are indicated for application in cases of poor bone density or placement in fresh extraction sockets. In the case of immediate implant placement, subcrestal placement is suggested. The planned level of implant placement should be taken into account when calculating the drilling depth.

In cases of very poor bone density, it is possible to substitute the standard drilling procedure with a bone condensing procedure, using the appropriate bone condenser tips.

CAUTION: do NOT use Max Stability Implants in thick cortical bone, equivalent to D1 bone density according to the Misch Classification.^[1]

The typology and the access to the surgical site shall be selected by the professional according to the clinical-morphological parameters. Schematically and with illustrative purpose only, the following steps for the preparation of the implant site are illustrated.

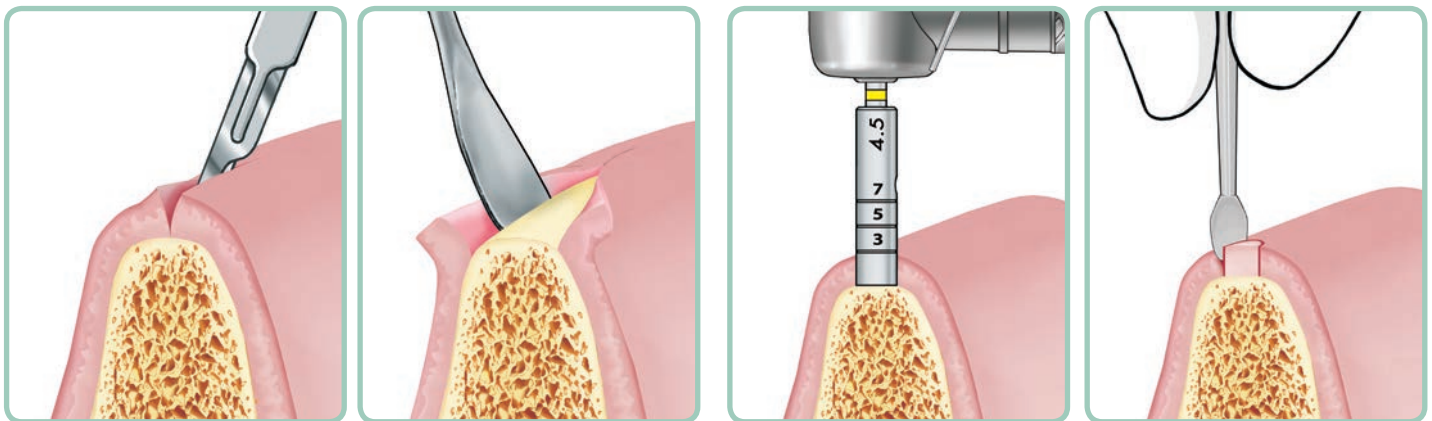

1.1a Make full-thickness incision of the soft tissues and detachment of the gingival flaps to have access to the bone ridge.

1.1b If flapless procedure is followed, use the proper mucosa punch for contra-angle. Set the handpiece to low speed (approx. 40 rpm). Use until bony tissue is met. To determine the gingival thickness around the implant area, the three black lines clearly visible around the mucosa punch, at the heights of 3-5-7 mm, starting from the crest bone, may be used.

For Ø3.75 mm implants: use mucosa punch for Ø3.75 mm implants Cat. 154-3815-20.

For Ø4.5 mm implants: use mucosa punch for Ø4.5 mm implants Cat. 154-4515-20.

Remove the tissue plug by using a small periosteal elevator.

^[1]Misch CE, Density of bone: effect on treatment plans, surgical approach, healing and progressive bone loading, Int J Oral Implant 1990; 6:23-31



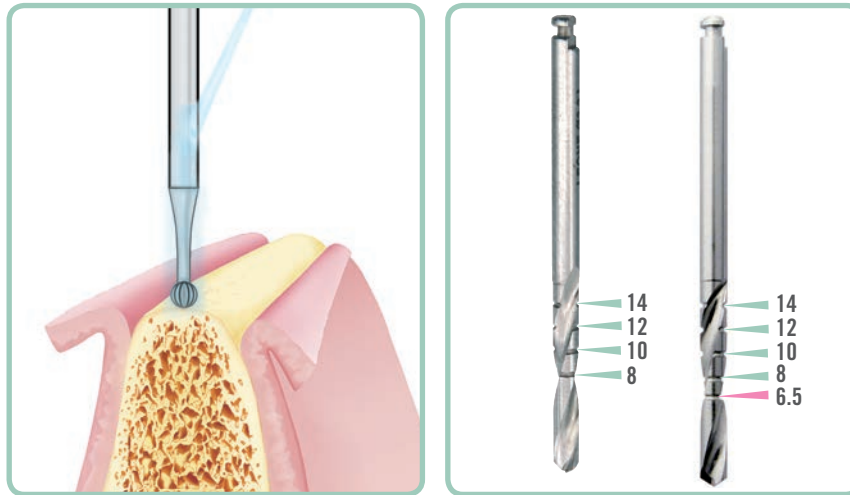

1.2 Use of the round bur Cat. 151-1934-01 to mark the cortical bone for the subsequent drills. Alternatively, it is possible to use the lance drill Cat. 151-1930-02, which is particularly suitable in case of narrow knife-edged ridges.

1.3 Prior to using any pilot or twist drill, it is important to check the number of the marks on the body of each drill:

- drills with 4 marks: 8 – 10 – 12 – 14 mm
- drills with 5 marks: 6.5 – 8 - 10 – 12 – 14 mm

The use of the depth indicators is recommended to better visualize the drilling depth.

The depth indicators are made of elastomer, for single use, manufactured in the colour code corresponding with implant diameter.

The depth indicators and the special positioner, available either in the surgical kit or single supplied (Cat. 151-0001-00 page 30), must be sterilized in the autoclave before use.

Choose the elastomer ringlet matching the diameter of the drill to be used (Ø2.2 mm pilot drill, blue colour; Ø2.8 mm twist drill, green colour; Ø3.5 mm twist drill, yellow colour; Ø4.2 mm twist drill, red colour).

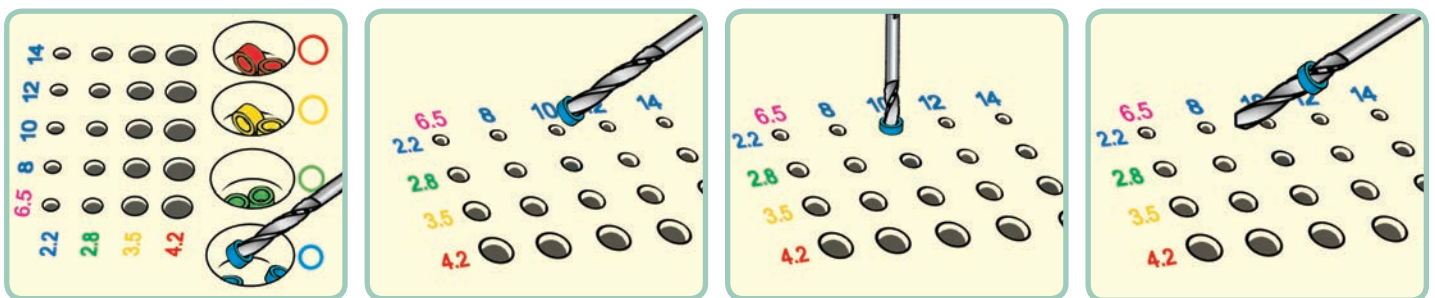

1.4 Seat the ringlet on the tip of the drill.

1.5 Placement of the drill into the hole corresponding to the diameter of the instrument and the selected depth.

1.6 Push the drill all the way to the stop.

1.7 In this way the depth indicator will be driven into position with the corresponding mark for the selected depth.

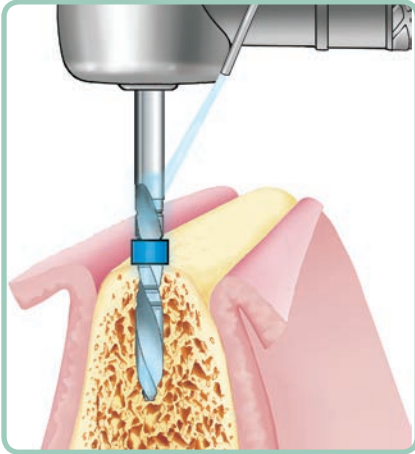

1.8 Use of the $\varnothing 2.2$ mm pilot drill: drill up to the depth mark **corresponding to the length of the selected implant** (max speed: 800 rpm with adequate irrigation).

In the case of subcrestal positioning, the planned level of implant placement should be taken into account when calculating the drilling depth.

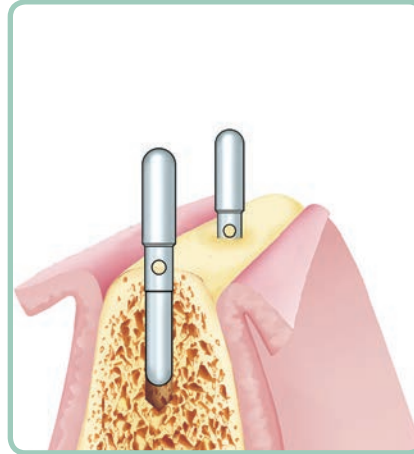

1.9a Use of paralleling pins for the control of parallelism with natural teeth and/or other adjacent implant sites. A radiographic exam can be performed to increase accuracy in the evaluation of parallelism. The paralleling pin can also be utilized after the application of a $\varnothing 2.8$ mm twist drill, taking care to seat the pin in the implant site using the side with larger diameter. Paralleling pins present a hole for the placement of a safety leash.

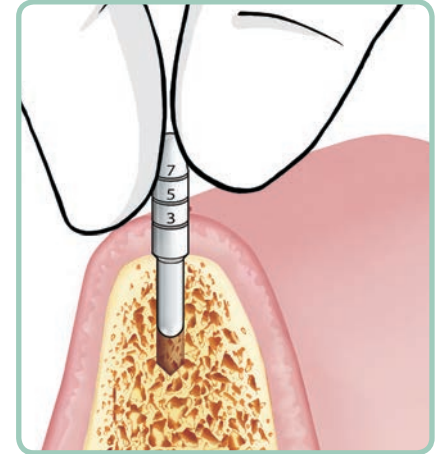

1.9b With flapless procedure, use a gingival height measuring pin to check the mucosa height and parallelism with natural teeth and/or other adjacent implant sites. Gingival height measuring pins present a hole for the placement of a safety leash.

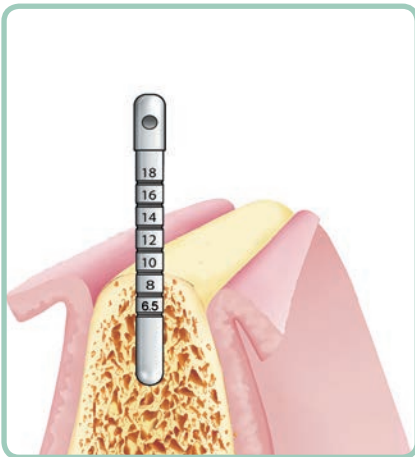

1.10 Use of the depth gauge to check the depth of the newly-created implant site. The depth gauge presents a hole for the placement of a safety leash.

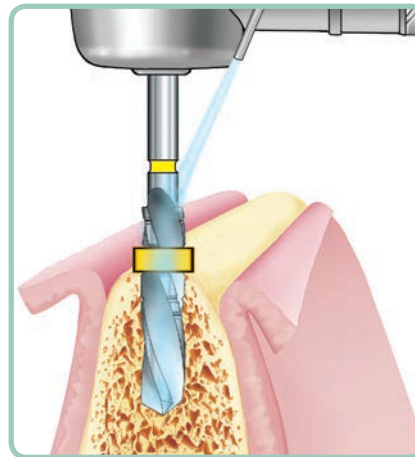

1.11 Widening of the diameter of the implant site with the progressive use of drills with increasing diameter. The drills have to be used up to the depth mark which **corresponds with the length of the selected implant**:

for $\varnothing 3.75$ mm implants: use a $\varnothing 2.8$ mm twist drill (short Cat. 151-2833-13 or long Cat. 151-2841-13) (max speed: 600 rpm)

for $\varnothing 4.5$ mm implants: after $\varnothing 2.8$ mm twist drill, use a $\varnothing 3.5$ mm drill (short Cat. 151-3533-13 or long Cat. 151-3541-13) for the final resizing of the site (max speed: 500 rpm).

Reminder: use adequate irrigation. In the case of subcrestal positioning, the planned level of implant placement should be taken into account when calculating the drilling depth.

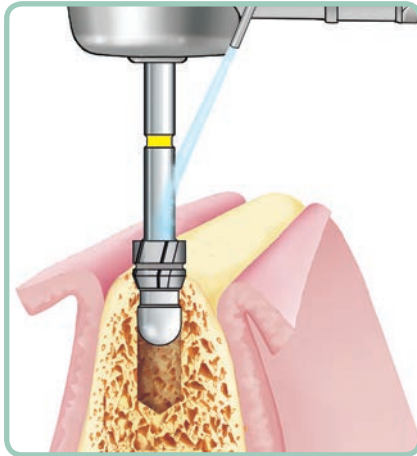

1.12 At the end of the widening operations of the implant site with the twist drills, use the countersink by inserting it up to the reference mark:

for Ø3.75 mm implants: use the Ø3.3 mm countersink drill (Cat. 151-3333-24) (max. speed: 300 rpm with adequate irrigation)

for Ø4.5 mm implants: use the Ø4.1 mm countersink drill (Cat. 151-4133-24) (max. speed: 300 rpm with adequate irrigation).

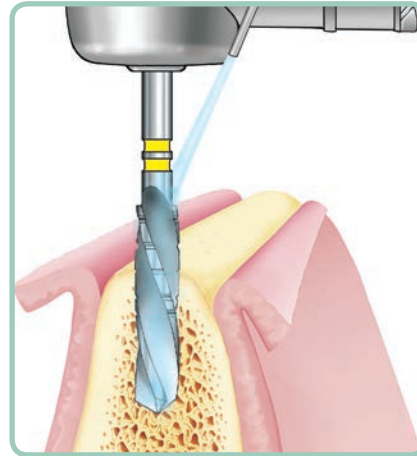

1.13 In the case of medium-to-high type D2 bone density, it is necessary to use a twist drill with a larger diameter than the one previously used, easily distinguishable by the two colour-coded marks on the drill's stem:

for Ø3.75 mm implants: use a twist drill for hard bone for implant Ø3.75 (short Cat. 151-3133-13 or long Cat. 151-3141-13) (max speed: 500 rpm)

for Ø4.5 mm implants: use a twist drill for hard bone for implant Ø4.5 (short Cat. 151-3833-13 or long Cat. 151-3841-13) (max speed: 400 rpm).

The drill must be used up to the depth mark which **corresponds with the length of the selected implant.**

Reminder: use adequate irrigation.

CAUTION:

In case of placement of a 14mm-long Max Stability implant in mature bone, for the final widening of the implant site always use the proper twist drill for hard bone up to the depth mark of 14 mm.



**2) LEONE MAX STABILITY IMPLANTS Ø 3.75 - 4.5:
PLACEMENT OF THE IMPLANT**

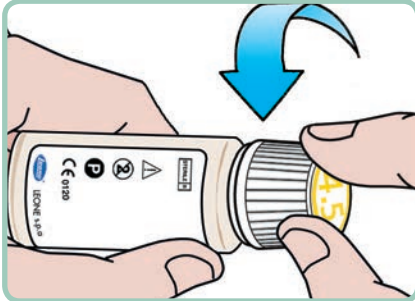

2.1 Unscrew the glass vial's top lid.

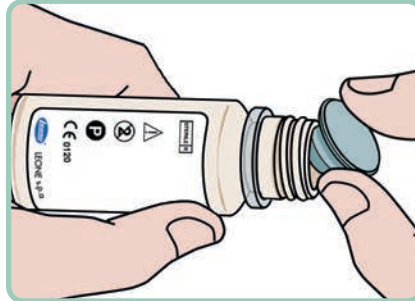

2.2 Remove the sealing cap.

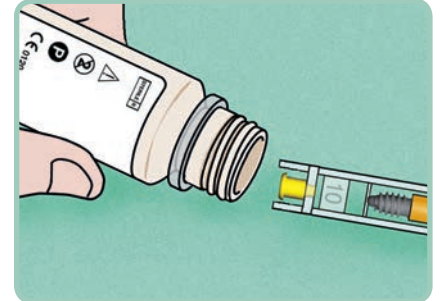

2.3 Extraction of the holder containing the implant and the cover cap on a sterile pad.

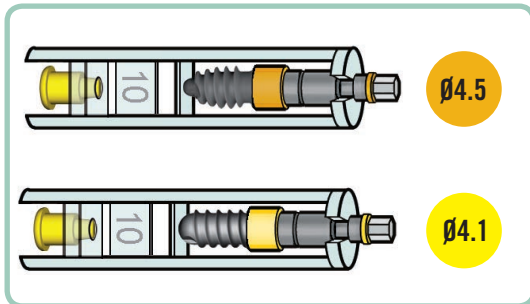

2.4 The connecting ring and the carrier's rubber ring are produced in a darker colour in order to distinguish the **LEONE Max Stability** implants from the cylindrical **LEONE** implants with the same length and connection size.

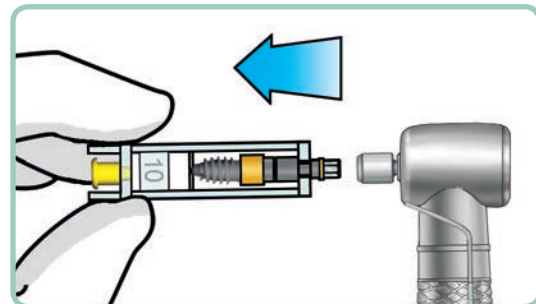

2.5 Connection of the handpiece adapter Cat. 156-1002-01 to the carrier of the implant. The use of the handpiece ensures maintenance of the implant site axis during the implant insertion in the prepared site.

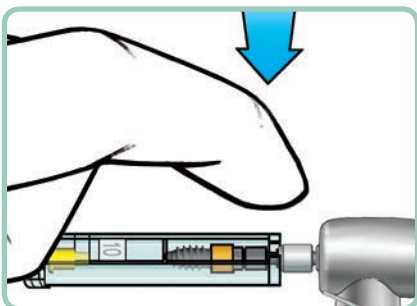

2.6 Extraction of the implant from the holder by exerting a pressure on the open side in order to detach the implant and make the holder fall down.

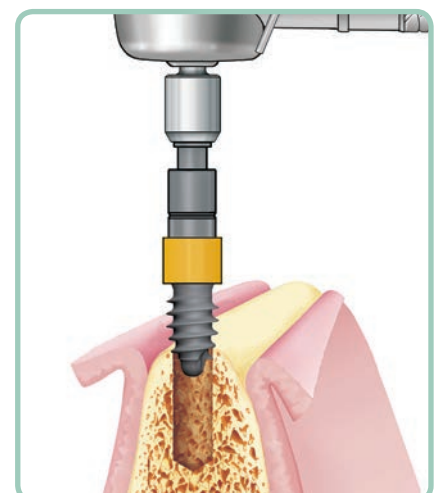
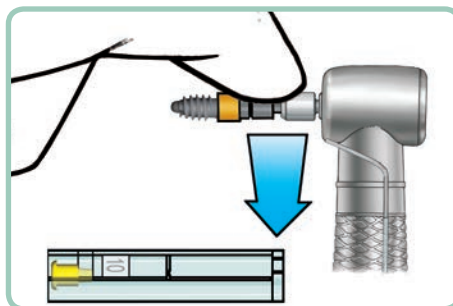

2.7 Initial seating of the implant into the implant site. If there is not enough space for a direct connection between the carrier and the handpiece adapter, the extension Cat. 156-1002-00 may be used.



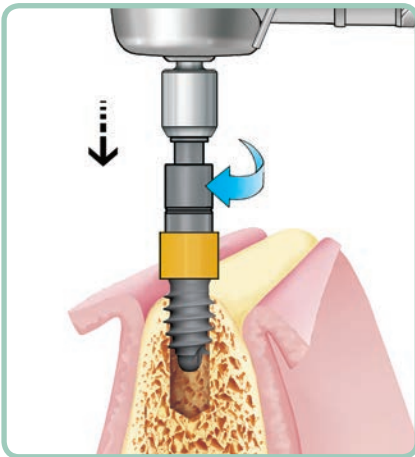

2.8 Insertion of the implant with a dental micromotor. Set a micromotor's maximum speed to 20 rpm and a maximum torque value to 50 Ncm. Insert the implant without irrigation.

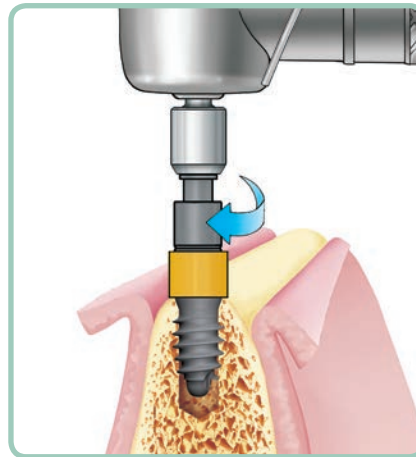

2.9 While driving the implant into the implant site, the rubber ring slides up along the carrier.

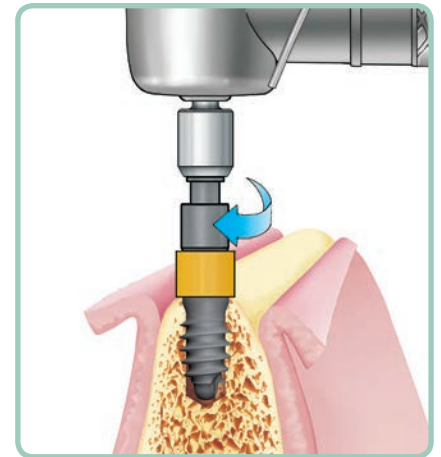

2.10 When the carrier's rubber ring has reached the reference line, the implant is exactly positioned at the level of the alveolar crest. Now the carrier can be easily disconnected from the implant.

CAUTION: the geometry of the LEONE Max Stability implant apex allows the implant to be inserted beyond the depth of the prepared site. Therefore, special attention should be paid to reaching the planned placement level related to the bone crest.

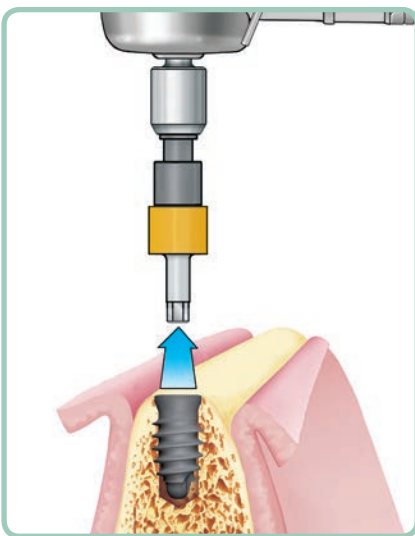

2.11 Removal of the carrier from the implant.

2.12 Rinsing and drying of the implant's inner side before placing the cap.

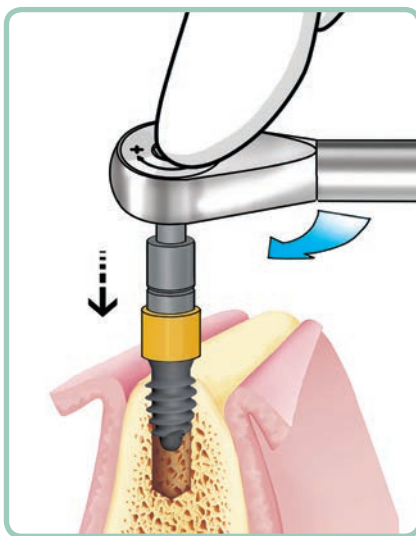

2.13 If the maximum torque value of 50 Ncm is not enough to complete the insertion of the implant, remove the handpiece adapter from the carrier and attach the ratchet Cat. 156-1014-00. Be sure the instrument is directed in the long axis by gentle pressing the head of the instrument with a finger.

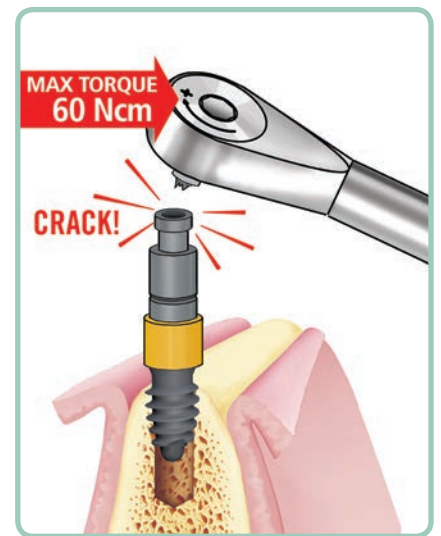

2.14 Should a ratchet be utilized, the forces exerted on the implant and on the correspondent peri-implant bone can become excessive. In this eventuality, should a value of 60 Ncm be exceeded, a torque limiting device will cause a fracture above the connection with the implant; now the carrier can be removed. Note that carrier fracture is not always visually perceptible, but is detectable by a sudden loss of functionality of the insertion instrument accompanied by a sharp crack.

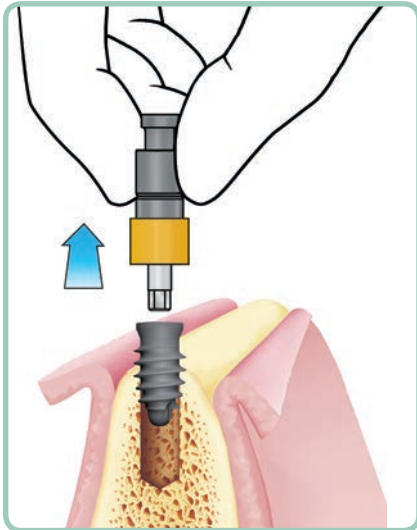

2.15 Removal of the fractured carrier.

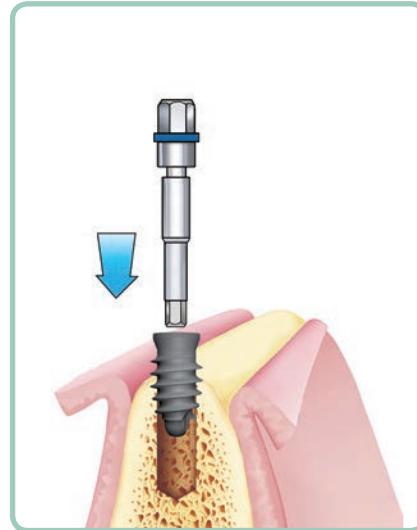

2.16a Replace the carrier with the implant driver (Cat. 156-1013-00 available either in the surgical kit or in the specific organizers) withstanding an applied torque of up to 140 Ncm.

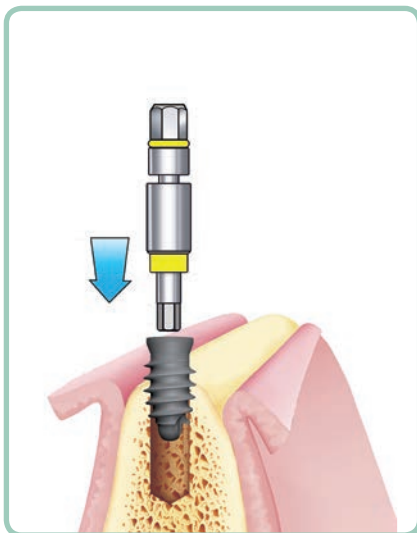

2.16b It is possible to use special drivers specific for each connection size, which are more stable thanks to the conical support ring and thus more resistant to the application of bending forces.

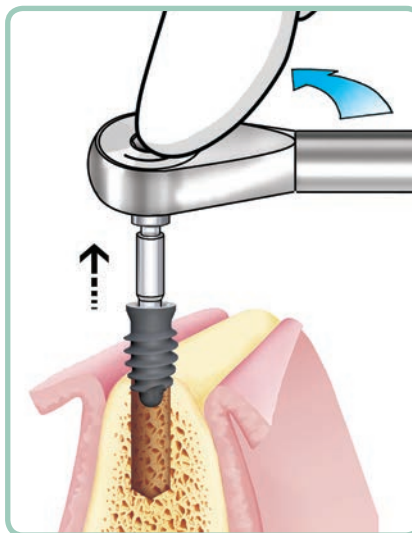

2.17 Attach the ratchet to the driver and remove the implant from the implant site.

2.18 Use the twist drill for hard bone of the diameter corresponding to the implant (see point 1.13). Then reinsert the implant using the micromotor, repeating steps 2.7-2.11.

CAUTION: Should it still be difficult to insert the implant after the use of the twist drill for hard bone, do not use the LEONE Max Stability implant because the bone density of the implant site is too high and does not comply with the indications for use of this implant.

We recommend placing a cylindrical LEONE implant with the same length and connection size.

For the following steps: Implant closure, Second stage surgery, Soft tissue conditioning, Prosthetic procedure, refer to the indications for the LEONE Implant System (pages 63..70 and 79), taking into consideration the following implant connection sizes:

Ø3.75 mm implant: same connection as the Ø3.3 mm LEONE implant (colour code: GREEN)

Ø4.5 mm implant: same connection as the Ø4.1 mm LEONE implant (colour code: YELLOW).



PROSTHETIC

procedure



for



implant system

DISCLAIMER

The Prosthetic Procedure and the use of the products of the LEONE Implant System described in the following pages are intended for Professionals experienced in dental implant techniques.

In case of lack of basic notions, we suggest to attend specific courses in order to reach a high level of knowledge and practice in the use of implants. The rules on the use of the products described below represent a group of standard instructions that must be adjusted to the single needs and to the particular situations that may occur according to the manual ability, to the experience and to the diagnosis made by the legally qualified medical operator. It is not ascribed to the manufacturer the duty of monitoring the procedures of use of the product. A correct and appropriate use of the instruments and products related to the **LEONE** Implant System shall completely be reverted to the clinician.

The prosthetic procedure hereunder described is merely indicative as any single treatment case is assigned to the experience of the operator. As every medical operator well knows, a correct procedure and a perfect manufacture of the prosthesis may sometimes be followed by not satisfactory results owing to particular situations not imputable to responsibility of the dental operator or the manufacturer.

PREMISE

The prosthetic procedure of the **LEONE** Implant System is similar to that used for the natural teeth.

For the preparation of the abutment and the realization of the definitive prosthesis on implants is possible to follow a “Direct Technique” or an “Indirect Technique.”

The Direct Technique consists in the placement of the abutment directly in the mouth of the patient and in its preparation in situ. The impression taking and the preparation of the prosthesis follow the same method used for the abutments of natural teeth.

The Indirect Technique consists in the impression taking with the placement of the transfer inside the implants to reproduce on the cast the exact position. Both impression and transfer are sent to the dental laboratory where the abutments, the definitive prosthesis or the temporary prosthesis (if the clinician decides to favour a further conditioning of the soft tissues and for the application of a progressive load) are manufactured.

CAUTION: *in case of corrections of notable problems of lack of parallelism among implants and whenever the use of special abutments is required, the use of the indirect technique is recommended.*

For the fabrication of provisional prosthesis, temporary abutments are available.

For every implant platform (Standard, Large and Slim) various types of abutments are available: cylinder and/or for the correction of possible lack of parallelism.

For Standard platform straight or angled anatomical abutments are available.

For the manufacture of removable prosthesis, ball head abutments for overdenture and abutments for screw-retained prosthesis suitable for bar-retained overdenture are available.

For the realisation of screw-retained prosthesis, specific abutments are available.

For selecting the most appropriate abutment for the specific case **two kits of try-in abutments** are available: one for the anatomical **LEONE 360°** abutments, one for all the other **LEONE** abutments.

CAUTION: *the patient should be informed about the precautions for the period after installation of the implant restoration in order to prevent complications and variations in the efficiency of the device: a good level of oral hygiene and periodical check-ups should be performed.*

1) INDIRECT TECHNIQUE: IMPRESSION TAKING

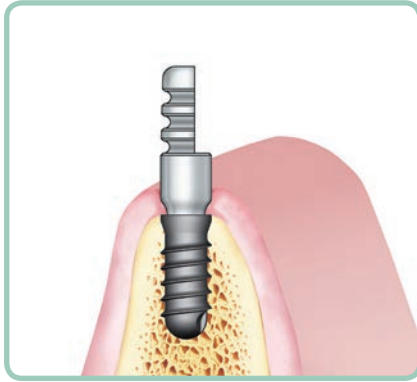

1.1 After having removed the healing cap, place the transfer related to the implant and the selected platform. After having found the engagement in the internal hexagon, exert pressure on the transfer to get a perfect connection.



1.2 Impression taking with one or two materials using either a one-step impression technique or a two-step impression technique. In case of two-step impression technique, after having taken the first impression, without the transfer, an adequate space in the material is created to take the second precision impression with a light body.

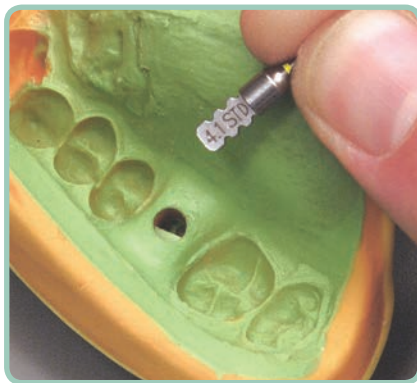

1.3 The transfer is kept in the impression due to the retentions. If this does not happen, it will be quite easy to reposition it in the impression, thanks to the particular shape of the transfer.

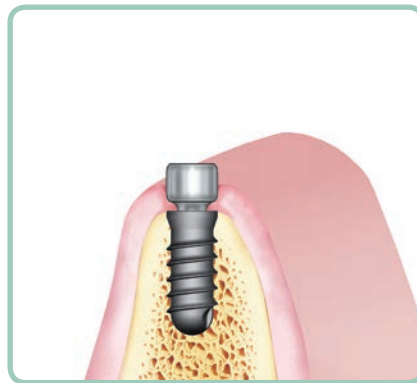

1.4 The impression is sent to the dental laboratory and a healing cap is positioned on the implant following the previous described steps.



2) INDIRECT TECHNIQUE: PREPARATION OF THE DENTAL CAST

2.1 Check for correct position of the transfer on the impression or, if necessary, reposition the transfer.

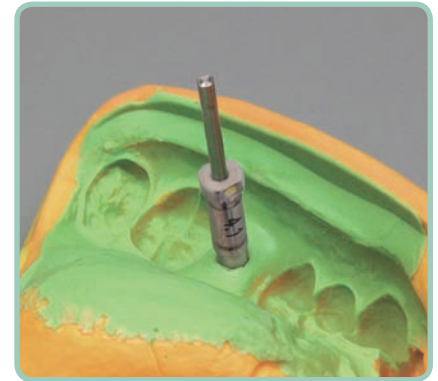
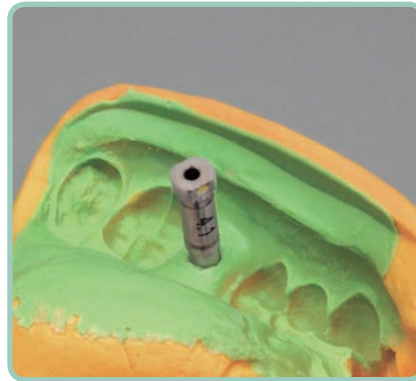
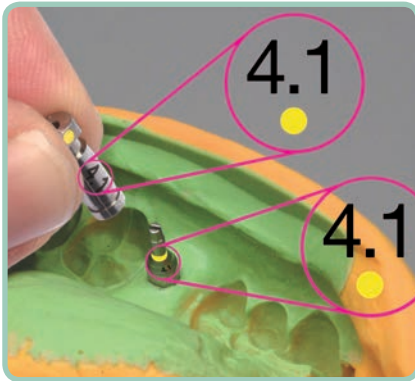

2.2 Verify the correspondence of the dimensions and the colour code on the surface of both analog and transfer. For the realization of dental casts with silicon gingiva, the use of the long analog is recommended. Placement of the analog on the transfer through the positioning hexagon which is present on the transfer. Exert a slight pressure on the analog until its complete placement.

2.3 CAUTION: *the analog must be seated completely in order to avoid errors in the fabrication of the dental cast.*

2.4 Placement of the pin on the analog. The connection among the two elements happens through a conic interference with no need of further fixing methods.

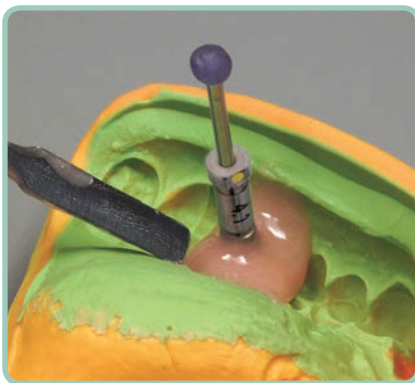

2.5 Placement of a small ball of wax on the top of the pin. The position of the ball will indicate the presence of the pin in case the pin would not come out of the dental cast. During this phase, non-rigid soft resin material can be used on the cast to mimic the presence of soft tissues. Pouring of the material that simulates the gingiva around the area of the analog.

2.6 The plaster is poured making sure that the position of the pin is not modified.

2.7 After curing of the plaster, the cast is removed from the impression carefully and it is checked for imperfections. Due to its retentive design, the transfer is kept in the impression.





2.8 The cast is trimmed until the wax over the pin gets exposed.

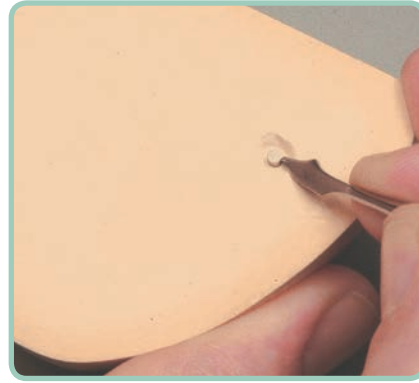

2.9 The opening on the plaster of the cast is widened when the gap created by the wax ball is not sufficient for the extraction of the pin.

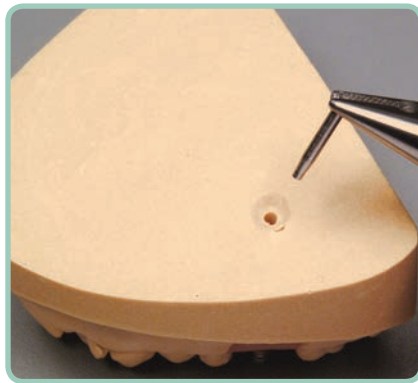

2.10 The pin is extracted from the cast with a laboratory plier. In this way, a posterior access canal to the analog is created.

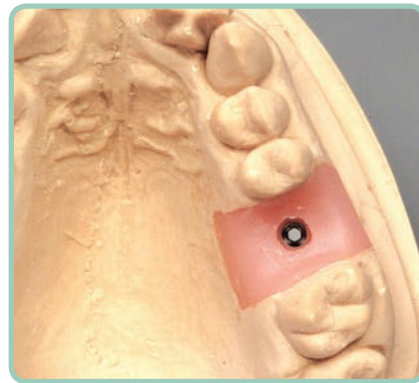

2.11 Final result: cast with analog seated in the correct position with regard to implant position in patient's mouth.

3) INDIRECT TECHNIQUE: PREPARATION OF THE ABUTMENT



3.1 With the use of try-in abutments (pages 15 and 28) select the ideal abutment, seat it on the analog engaging the internal hexagon and applying an impulsive force (beat gently on the top of the abutment with a mallet). Control of the dimension and planning of subsequent modifications.

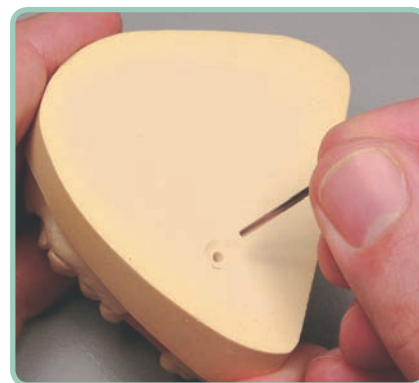

3.2 Placement of the specific bar for removal of the abutment into the access canal previously created on the base of the cast.



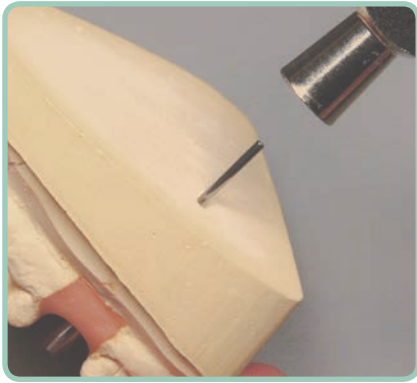

3.3 Percussion with a mallet and extraction of the abutment from the analog.



3.4 Placement of the abutment onto the specific handle for abutments, engaging the internal hexagon and applying an impulsive force. The handle facilitates the reduction of the abutment and prevents any damages to the abutment. It also avoids problems due to overheating and unstable grips.

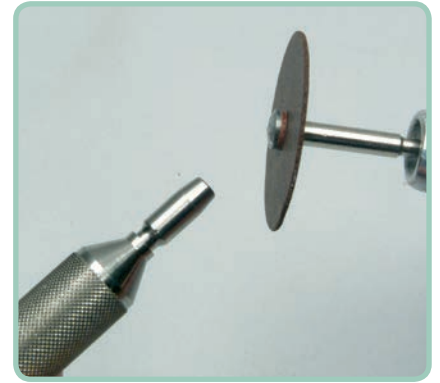

3.5 First phase of the reduction of the abutment seated on the handle. The abutments of the **LEONE** Implant System allow an easy preparation both in the laboratory and in the patient's mouth, due to the particular quality of the titanium utilized and to their design (solid abutments). Separation disks and cross cut tungsten carbide burs are particularly indicated for this type of preparation.



3.6 Removal of the abutment from the handle. The handle has a special push-button that allows a simple and rapid ejection of the abutment.



3.7 Placement of the semi-finished abutment in the analog and application of an impulsive force. If necessary, the abutment can be finished on the cast with a milling parallelometer.

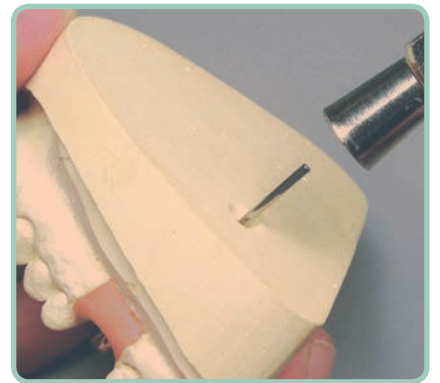

3.8 Placement of the specific bar for removal of the abutment in the access canal created previously on the base of the cast. Percussion with a small mallet and extraction of the abutment from the analog.

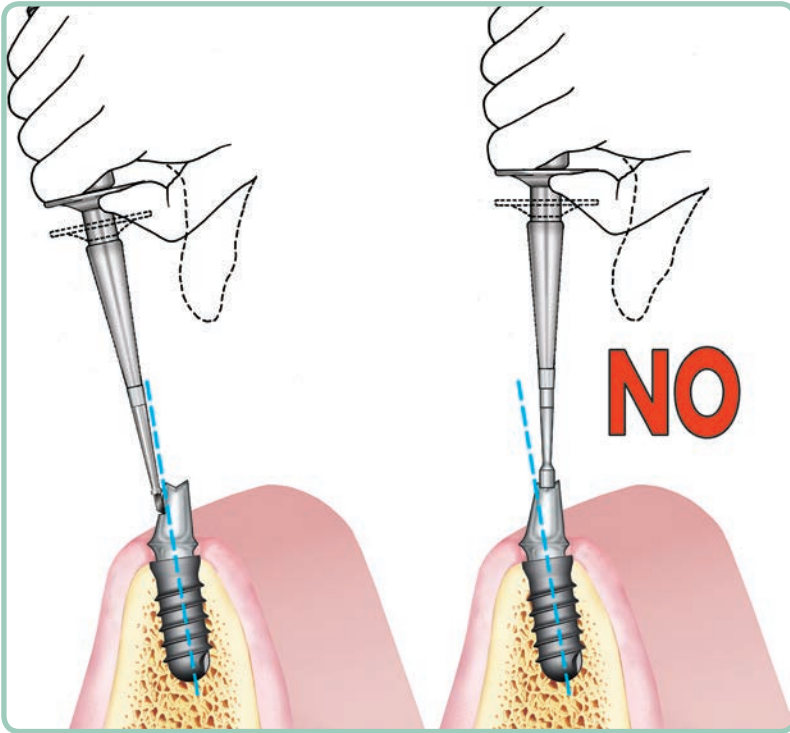

CAUTION: in case of angled abutments, create a step parallel to the axis of the cone. The abutment beater with the specific flat tip will be placed on the step for a correct percussion of the abutment on the implant. The anatomical abutments already show a step parallel to the axis. Percussion on the angled and pre-inclined abutments must be performed with the special flat seating tip Cat. 156-1008-06 placed on the step and by aligning the instruments along the implant axis. On the contrary, the seating tip might not find the correct support on the step and slip sideways. In order to get a permanent connection, at least 2 consecutive percussions are advisable.

3.9 Waxing, casting and try-in of the coping or of the framework on the abutments that will be marked with numbers indicating their position and with a sign on the vestibular side. Manufacture of a temporary prosthesis. Sending of abutments and copings or frameworks and temporary prosthesis to the dental office.



**4) INDIRECT TECHNIQUE:
SELECTION, USE AND POSITIONING OF LEONE 360° ANATOMICAL ABUTMENTS**

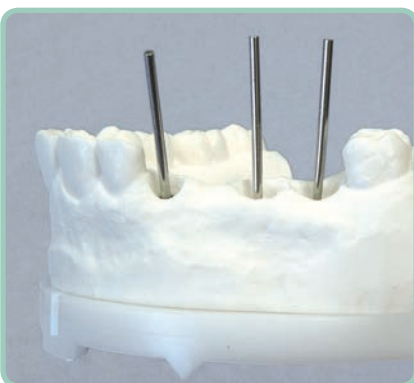

4.1 Highlight the different implant inclination by seating the bars (included in the package) or the related try-in abutments on the analogs.



4.2 Selection of the most appropriate abutment from the try-in kit for **LEONE 360°** anatomical abutments (Cat. 160-0001-03). It is now possible to order the correct selected abutment.

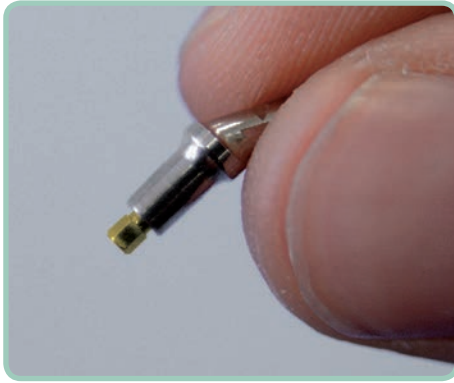

4.3 The apical hexagon is only seated but **not locked** in the 360° anatomical abutment: this allows a free positioning to 360° on the dental cast. When supplied, the conical locking-taper connection between the hexagon and the abutment is not activated, therefore the hexagon can rotate on the abutment.

4.4 Engage the internal hexagon and gently press the abutment on the corresponding analog on the dental cast.

CAUTION:

*do not place the **LEONE 360°** anatomical abutment without the hexagon into the dental cast.*

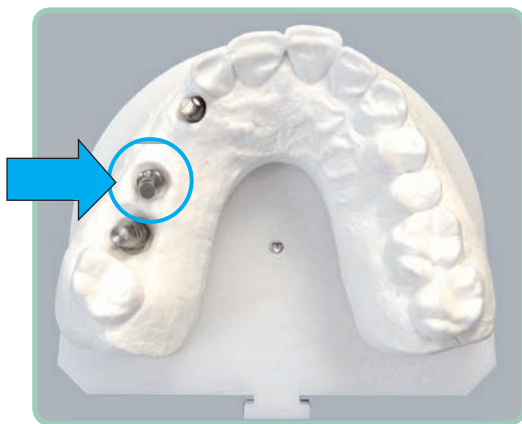

4.5 The angular position of the hexagon is casual and accordingly the abutment emergence.

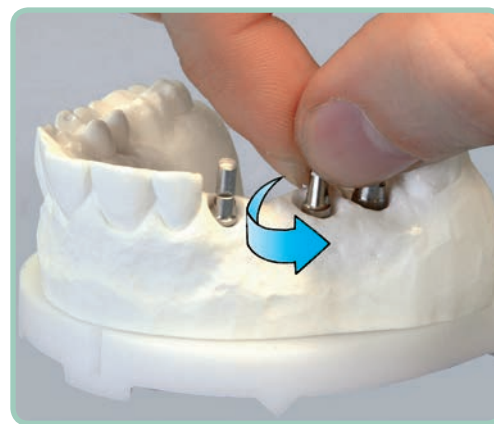

4.6 Take the **LEONE 360°** anatomical abutment and rotate it to its correct angular position. Eventually use universal pliers.

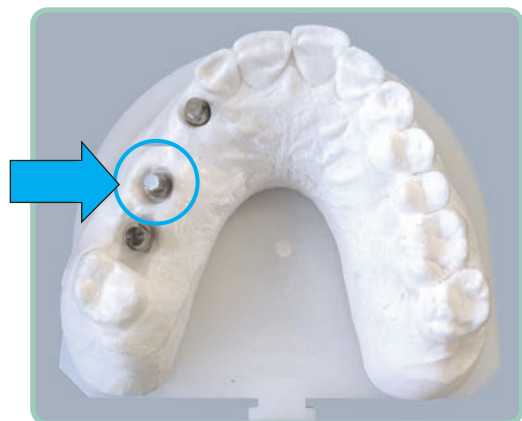

4.7 In this way the best parallelism among abutments has been set and the placement axis has been selected.



4.8 Fix the position through an impulsive force on abutments.



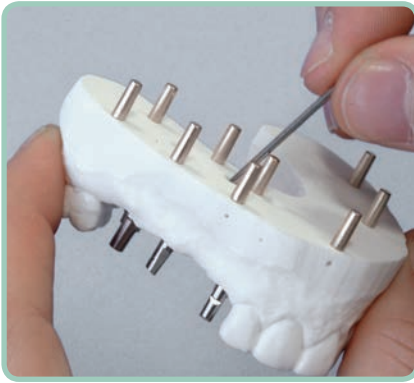

4.9 Placement of the special bar for the abutment removal into the access channel on the bottom of the dental cast.

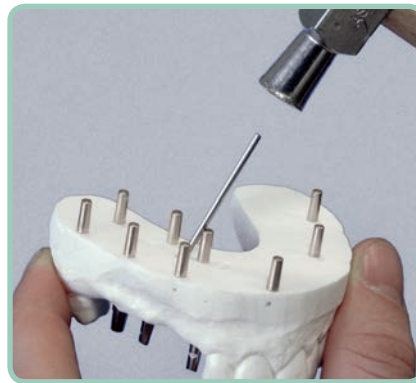

4.10 Application of an impulsive force on the pin. The hexagon is permanently fixed to the abutment and at the same time the abutment is being removed from the analog.

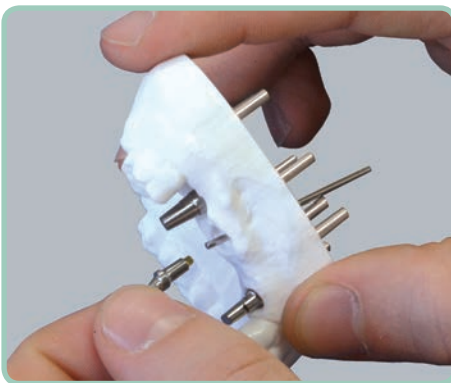
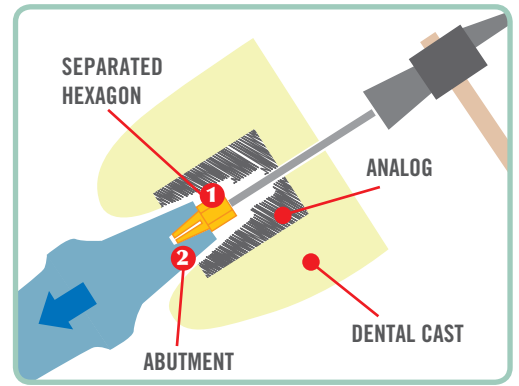

4.11 Extraction of the abutment from the dental cast. The hexagon is now fixed in the most favourable position for the prosthetic restoration and has been pushed all the way down up to the end stop on the abutment body. Finishing of the abutment, if necessary, and manufacturing of the framework making reference to points 3.4-3.9.

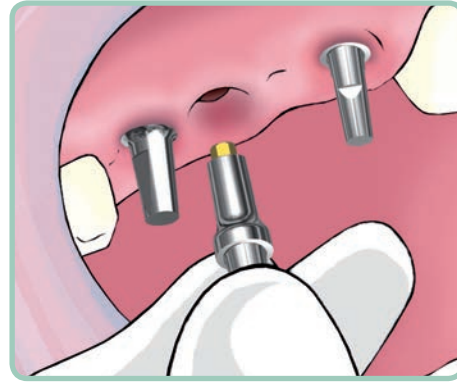

4.12 Once activated the self-locking conical connection ensures the stability of the hexagon and the positioning of the abutment in the mouth is only one-way. For the final positioning of the abutment, follow the general instructions indicated at points 5.1-5.6.

In case of choice of a **LEONE 360°** anatomical abutment either angled at 15° or 25°, the activation of the connection must be performed on the special step with the flat tip Cat. 156-1008-06.

CAUTION: before doing any finishing or try-in of the framework, always secure the abutments with an impulsive force in order to prevent unwanted movements of the hexagon.



5) INDIRECT TECHNIQUE: FINAL POSITIONING FOR STANDARD AND LARGE PLATFORM

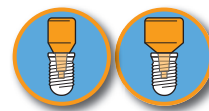

The prosthetic technique of **LEONE** Implant System is similar to the one always used on natural teeth.
The dental office receives the prepared abutments, the cap or the metal framework and the temporary prosthesis from the laboratory.
For the fabrication of provisional prosthesis with temporary abutments see paragraph 12.

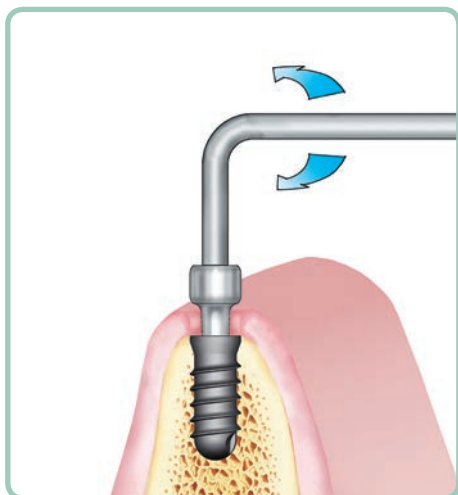

5.1 Unlock the healing cap with the specific hex head extractor Cat. 156-1006-00. The extractor, which presents a hole for the placement of a safety leash, is seated into the hexagon on the head of the healing cap and rotated subsequently, either clockwise or anti-clockwise indifferently, in order to unlock the healing cap. The removal of the cap from the implant is completed with the aid of tweezers.

Accurate rinsing and drying of the inside of the implant.

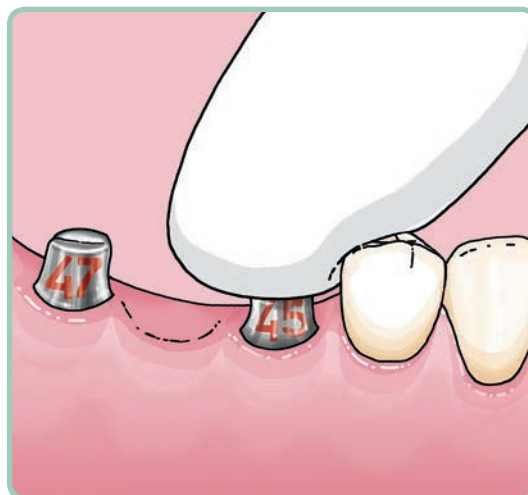

5.2 For the abutment try-in, the abutments are placed inside the implants paying attention to the corresponding numbers. The hexagonal engagement is found and a light finger pressure is exerted on the abutments. By doing so, the abutments will be sufficiently retained inside the implants and, if necessary, at the end of the try-in procedure, the abutments can be easily removed either manually or with the help of Weingart style pliers (LEONE Orthodontic Cat. No. P2104-00).

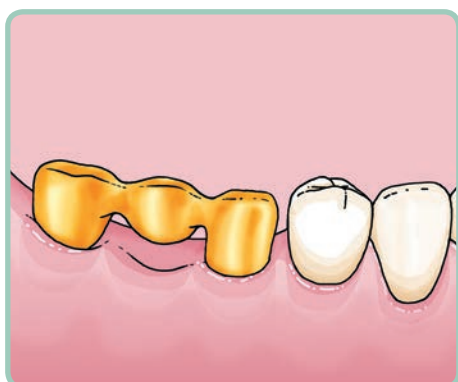

5.3 Try-in of the coping or of the framework on the abutments.

Once the perfect fit of the metal structure and the abutments has been checked, the copings or the framework are sent to the laboratory for the completion of the manufacturing process.^[1]

^[1]In the event of an imperfect fit of the framework, it may be cut and repositioned on the abutments if suggested by the clinician. The fit of the framework is checked in the mouth of the patient and the framework is fixed with self-curing resin. Once the final set of the self-curing resin has occurred, an impression is taken with the framework still in place. The framework kept in the impression is sent to the laboratory for final soldering the technique is the same as the one on natural teeth.



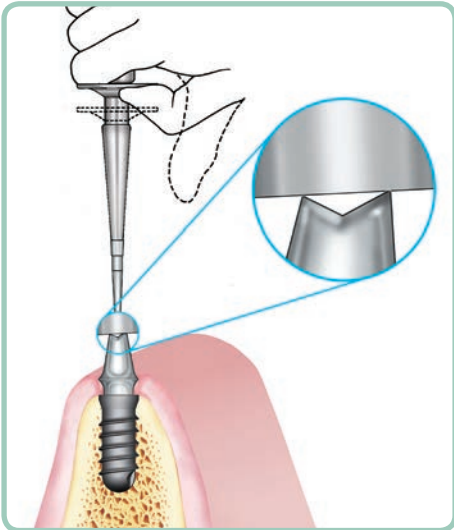

5.4 The clinician may decide for the final placement of abutments inside the implants by placing a temporary prosthesis. In this case, the placement of the abutments is performed by applying an impulsive force along the longitudinal axis of the implants with the special abutment beater. In order to get a permanent connection, 2 consecutive percussions are advisable. In case of seating an abutment in the posterior region, use the specific offset tip Cat. 156-1008-02. In that case we recommend to perform 3 consecutive percussions. In case of seating an angled abutment, please refer to the indications on page 87.



5.5 Application of a temporary prosthesis may promote further conditioning of the soft tissues and application of a progressive loading. As an alternative, the abutments can be removed with a pliers and the healing caps are repositioned. Once the final prosthesis is ready, the healing caps are removed, the abutments are definitively seated and the prosthesis is applied.

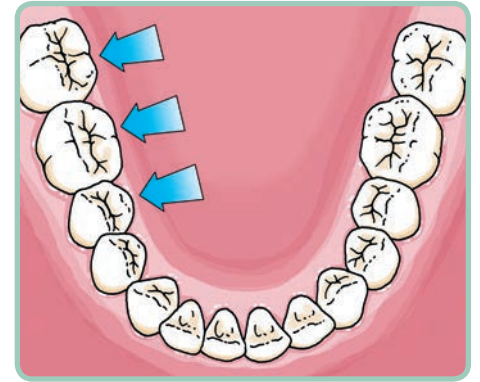

5.6 Once the prosthodontist has decided to apply the final manufacture, the temporary prosthesis is removed. After final touches and polishing, the final prosthesis is positioned and cemented.



6) INDIRECT TECHNIQUE: FINAL POSITIONING FOR SLIM PLATFORM

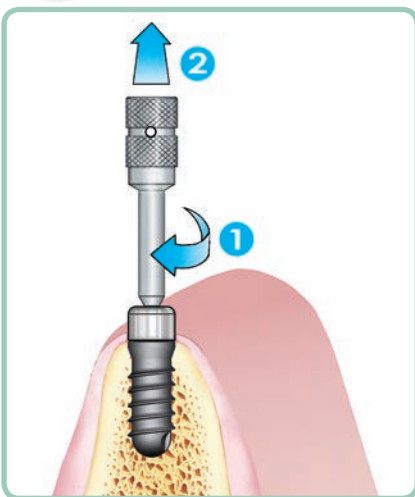

6.1 Removal of the healing cap with the special instrument for cover caps Cat. 156-1003-00. The instrument for cover caps has to be screwed in the head of the healing cap to be able to practice enough traction to remove the cap.

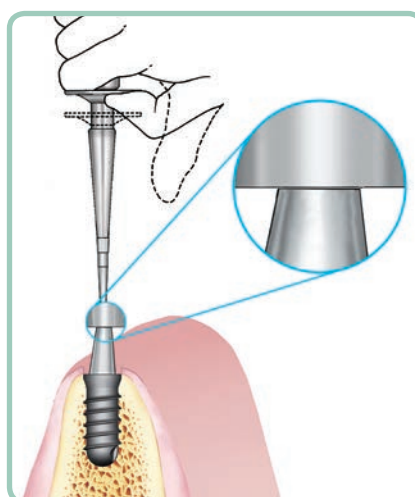

6.2 Final placement of the abutment in the implant through the application of an impulsive force along the longitudinal axis of the implant with the special abutment beater. To get a permanent connection, 2 consecutive percussions are advisable.

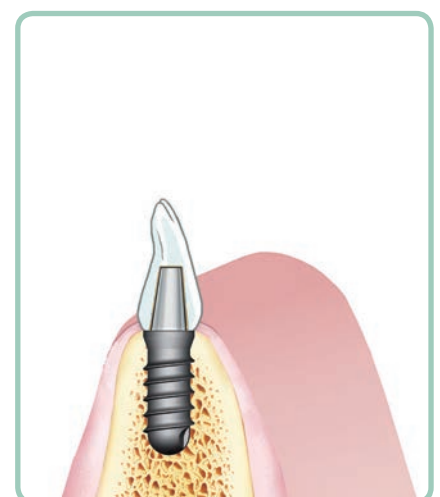

6.3 Cementation of the crown closing on the neck of the implant.



7) DIRECT TECHNIQUE: POSITIONING AND PREPARATION OF THE ABUTMENT, IMPRESSION TAKING FOR STANDARD AND LARGE PLATFORM

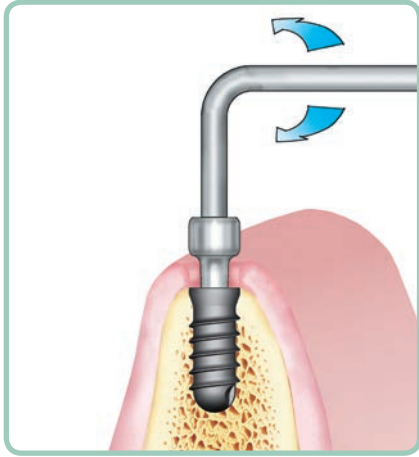
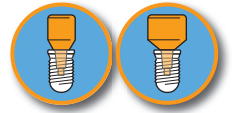

7.1 Unlock of the healing cap with the specific hex head extractor Cat. 156-1006-00. The removal of the cap from the implant is completed with the aid of tweezers. Accurate rinsing and drying of the inside of the implant.

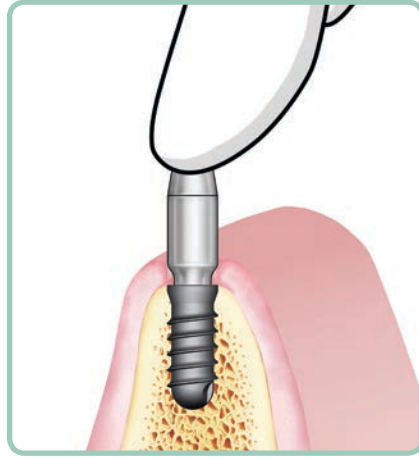

7.2 Selection of the most appropriate abutment with the use of the try-in kit for Standard and Large abutments (Cat. 160-0001-04). Try the abutment in the mouth of the patient. Placement of the abutment in the implant engaging the internal hexagon. Use finger pressure to get a retention of the abutment inside the implant. Highlighting of possible parts to be trimmed. Hand removal of the abutment or with the help of Weingart style pliers (LEONE Orthodontic Cat. No. P2104-00).



7.3 Eventual rough shaping of the abutment, especially in height, with the aid of the special handle for abutment.

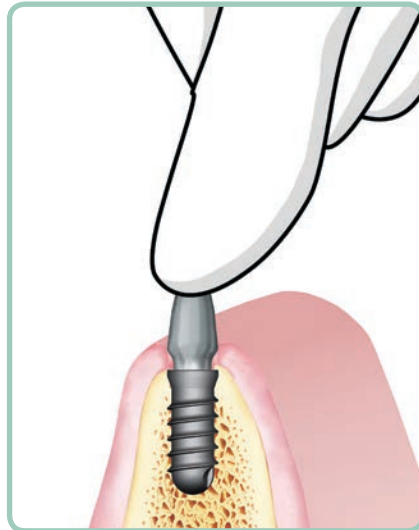

7.4 When rough shaping is finished, placement of the abutment in the implant engaging the internal hexagon.

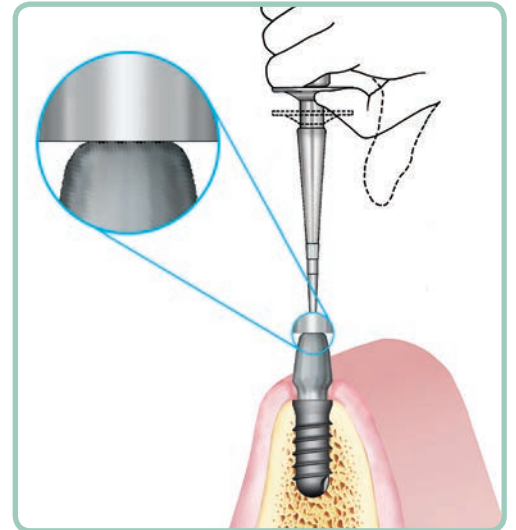

7.5 Percussion of the abutment with the specific abutment beater on the longitudinal axis of the implant. To get a permanent connection, 2 consecutive percussions are advisable. In case of seating an abutment in the posterior region, use the specific offset tip Cat 156-1008-02. In that case we recommend to perform 3 consecutive percussions. In case of seating an angled abutment, please refer to the indications on page 87.

7.6 Milling of the abutment directly in the patient's mouth **under profuse irrigation**. The abutments of the **LEONE** Implant System allow an easy preparation both in the laboratory and in the patient's mouth thanks to the low thermic conductivity coefficient of the titanium with which they are manufactured.

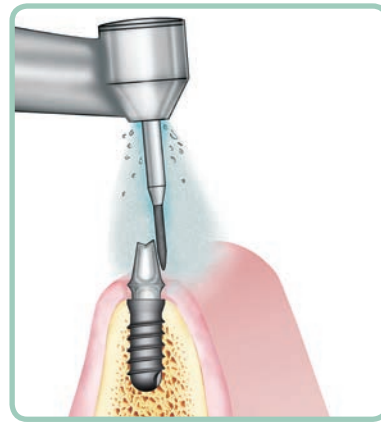
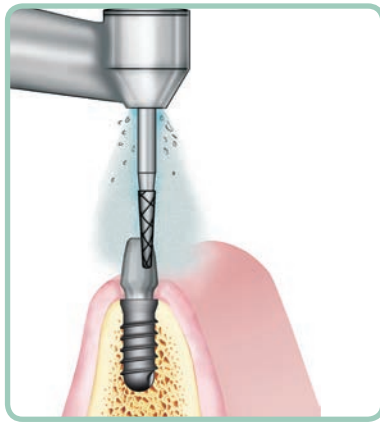

7.6a For important cuts in height and rough shaping, the use of a cross cut tungsten carbide bur Cat. 153-1221-02 or Cat. 153-1235-02 (included in the specific organizer) is recommended. We advise to prepare the abutment as a chamfer.

7.6b For the final finishing use a coarse-cut diamond bur Cat. 153-1610-01 or Cat. 153-1810-01 included in the specific organizer.

7.7 Impression taking with classical technique as on the natural teeth and dispatch of the same to the dental laboratory for the preparation of the prosthesis. The application of a temporary prosthesis is advisable to get a conditioning of the soft tissues.



8) BALL HEAD ABUTMENTS FOR OVERDENTURE

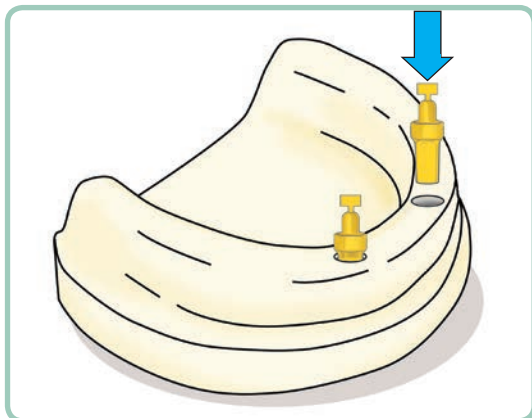

8.1 After the healing of soft tissues, take the impression with the conventional indirect technique using Standard transfers, send the impression to the lab and pour the dental cast (par. 1 and 2 of the prosthetic procedure). Select the appropriate ball head abutments according to the thickness of gingival tissues and inclination of implants, using the try-in abutments kit Cat. 160-0001-04. The abutment must protrude from the gingiva by at least 1 mm to avoid a possible impingement of the housing on the patient's soft tissues.

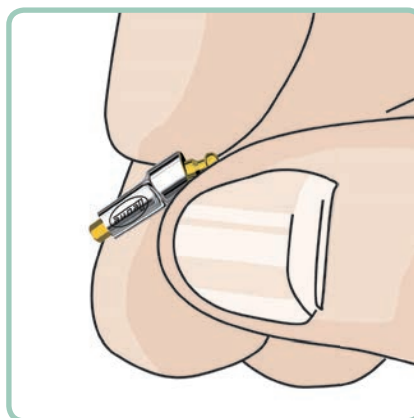

8.2 In case of **360° angled ball head abutments**, the procedure for permanently fixing the hexagon to the abutment body is like the one for **LEONE 360°** anatomical abutments (points 4.3 – 4.11 of the prosthetic procedure). Deliver the dental cast and the selected abutments to the dental office.

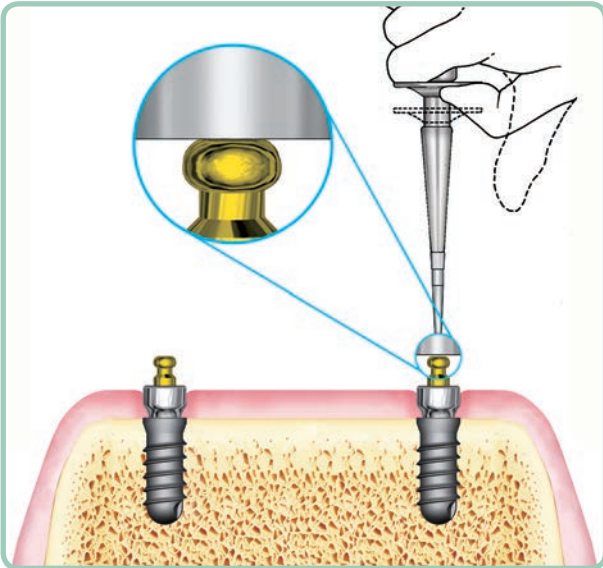

8.3 After the removal of the healing caps (point 7.5 of the surgical procedure), rinse and dry the implant's inner side, seat the ball head abutments into the implants and apply an impulsive force onto the abutments' heads. To get a permanent connection of **straight ball head abutments 2 consecutive percussions** with the proper abutment beater are recommended; on **angled abutments perform 4 consecutive percussions**.



8.4 Choose one attachment type of the following options:
 1) housing with O-ring
 2) micro housing with O-ring
 3) micro housing with insert.
 All attachments, which will be incorporated into the prosthesis, must belong to the same type.

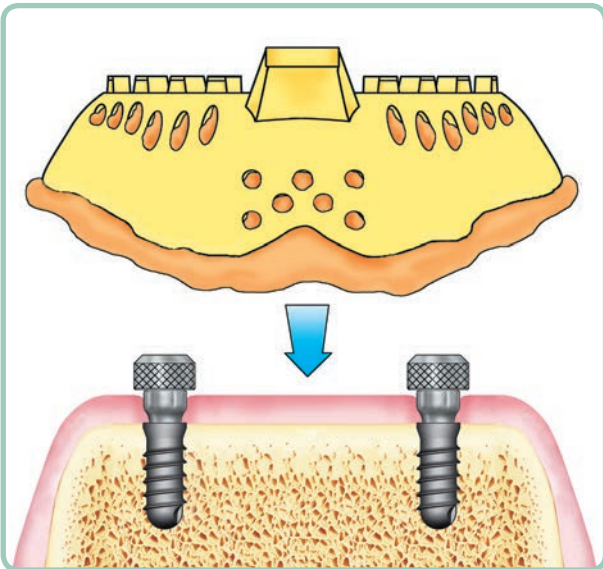

8.5 Place the chosen housings on the abutments' heads. Take an impression and send it to the lab. In this way, the manufacturing of the definitive prosthesis can occur with an adequate space for the housings. Remove the housings and adapt the temporary prosthesis, if necessary.

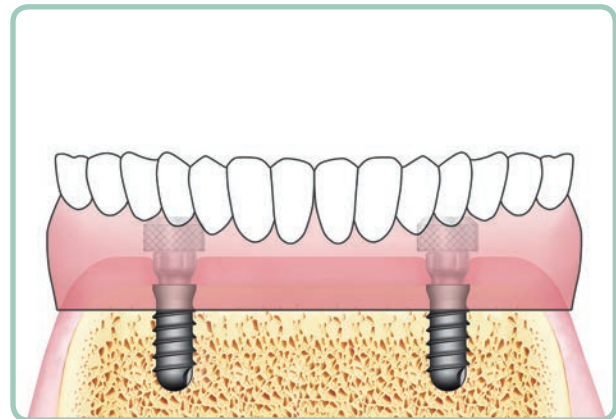

8.6 Check the final prosthesis, particularly in relation to the space left for the housings.

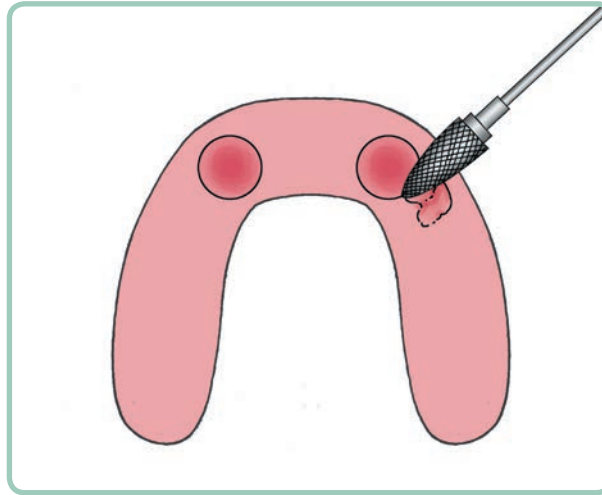

8.7 If necessary, relieve the prosthesis in the areas for the housings, in order to obtain a perfect tissue borne prosthesis without any friction on the housings.

CAUTION: *It is recommended to deliver the final prosthesis in the initial phase without housings to the patient to allow for adequate tissue adaptation and to correct possible impingements. The clinician will determine the length of the adaptation period.*

8.8 After adaptation, place over each abutment the proper spacer ring suitable for the selected housing. The spacer rings allow a precise incorporation of the housings into the prosthesis without displacements, promote a correct resilient retention of the prosthesis and protect the undercuts of the abutments' heads from acrylic.

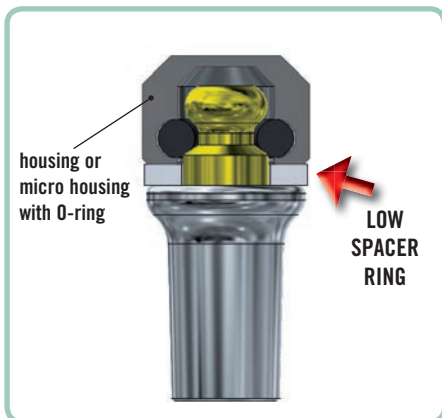

8.8a The **LOW** spacer ring is used to incorporate the housing with O-ring or the micro housing with micro O-ring into the prosthesis.

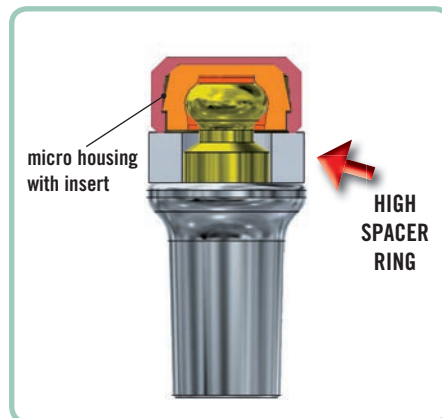

8.8b The **HIGH** spacer ring is used to incorporate the micro housing with insert into the prosthesis along the head axis of the abutment.

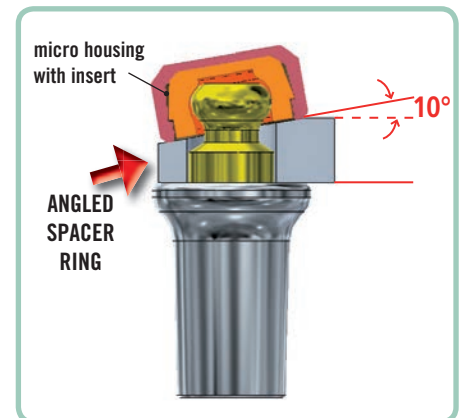

8.8c The **HIGH ANGLED** spacer ring, easily recognisable due to a protrusion at its maximum thickness, is used to incorporate the micro housing with insert into the prosthesis with an angle increased by 10° in respect to the abutments head.

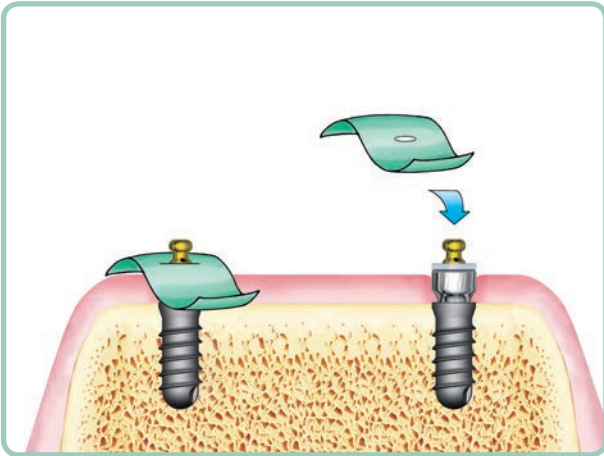

8.9 Place squared pieces of rubber dam over each abutment to avoid a direct contact between the soft tissue and the acrylic.

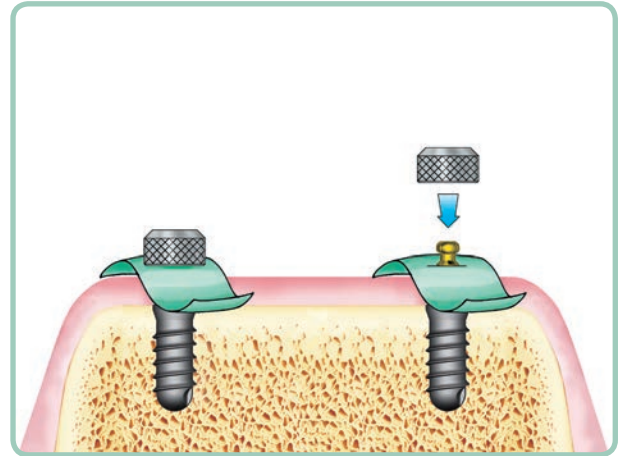

8.10 Place the housings onto the abutments' heads. Please remember that all housings should be incorporated at the same time into the prosthesis and not at different moments.

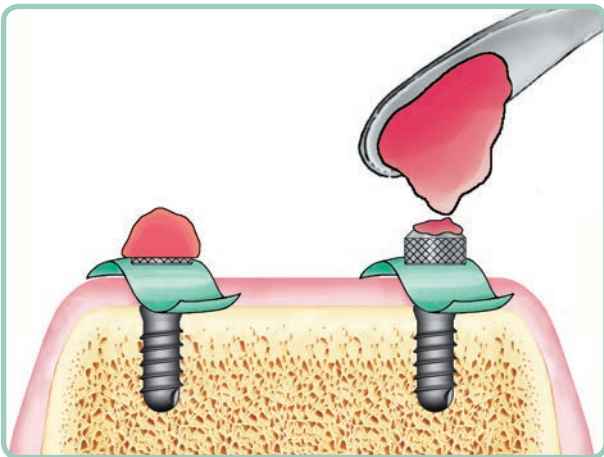

8.11 Apply acrylic to the housings.

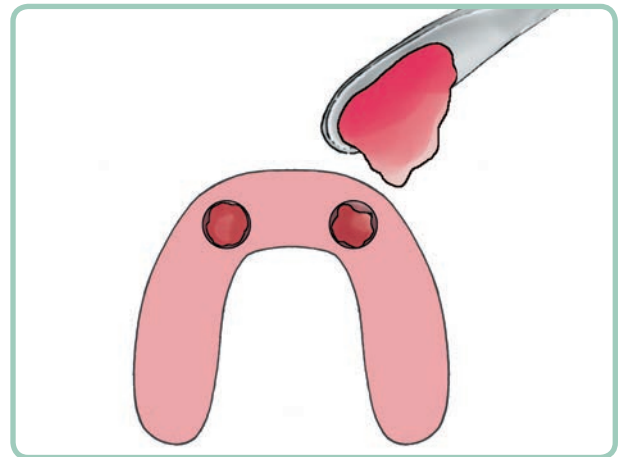

8.12 Place acrylic into the relief areas of the prosthesis.

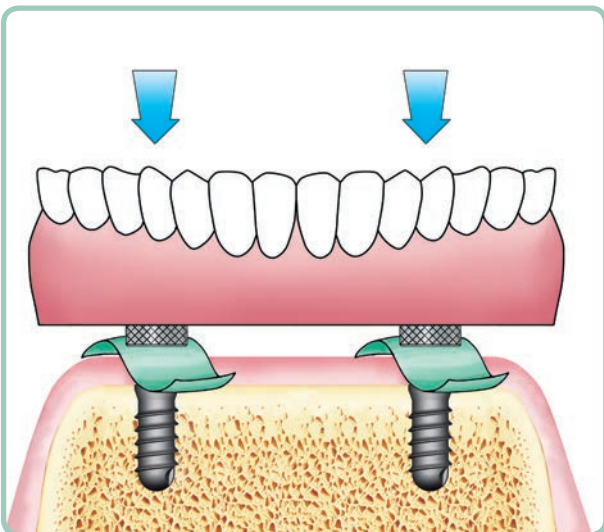

8.13 Place the prosthesis into position in the mouth.

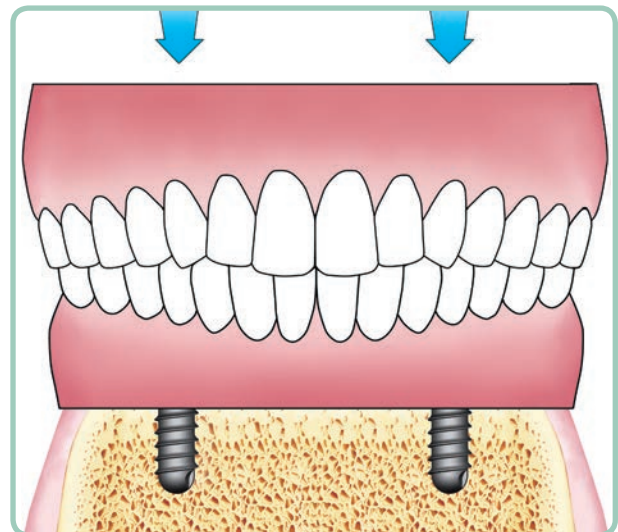

8.14 Have the patient close into proper occlusion.

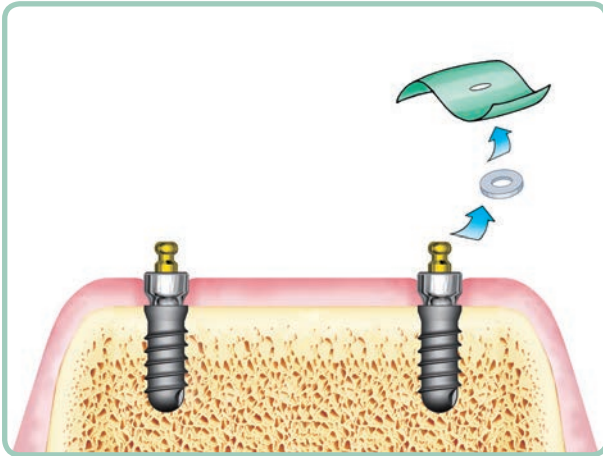

8.15 After the polymerization of the acrylic has been completed, the prosthesis is removed from the patient's mouth. The housings, due to their highly retentive surface, are kept in the prosthesis. Remove the rubber dams and the spacer rings from the abutments.

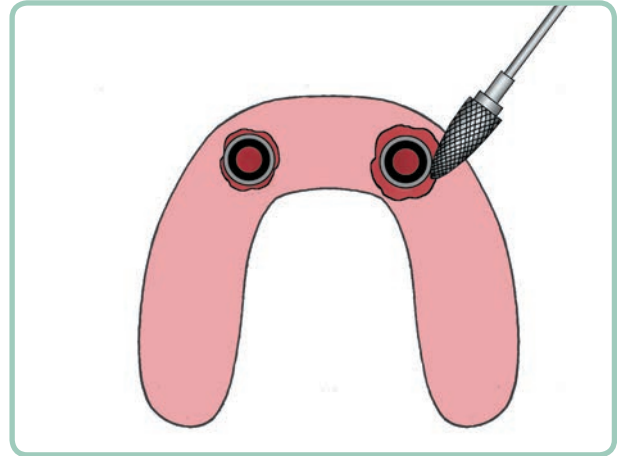

8.16 Remove excess acrylic until the lower border of the housings is fully uncovered. Remove acrylic that could create impingement problems close to the implants. After polishing, the prosthesis is delivered to the patient.



REPLACING AN O-RING

When replacing an O-ring, remove the old O-ring from the metal housing and lubricate the new O-ring with silicone spray or Vaseline to facilitate placement within the metal housing. Insert the new O-ring into the housing by using plastic forceps. Use a round-shaped instrument which can enter into the hole of the O-ring to push it into its seat with small circular movements. To improve visibility we recommend to work using a magnifier with a magnification of at least 4x.



REPLACING AN INSERT

When replacing an insert, remove the old insert from the metal housing and insert a new one by means of the specific insert seating tool Cat. 156-1004-00. Place the insert onto the tip of this tool. Use the seating tool to push the insert all the way into the housing, until you hear a click indicating that it is properly locked into place. Check whether the insert is fully seated into the housing and that the border of the insert is flush with the border of the housing.



PROSTHESIS MAINTENANCE

Patients should be reviewed at least once every six months. Review should include assessment of prosthesis retention, replacement of damaged females (O-rings or inserts) or change of insert type, if the patient needs a different level of retention. In case of prosthesis relining, at the end of the procedure always replace the O-rings or the inserts. If a simple prosthesis relining procedure is insufficient and it is necessary to reincorporate the metal housings into the prosthesis, remove the housings with a small bur and replace them with new housings following the above-mentioned indications (points 8.8 – 8.16). Please remember that all the housings within the prosthesis should always be reincorporated together into the prosthesis and not only one or part of them.



9) BAR-RETAINED OVERDENTURE AND SCREW-RETAINED PROSTHESIS

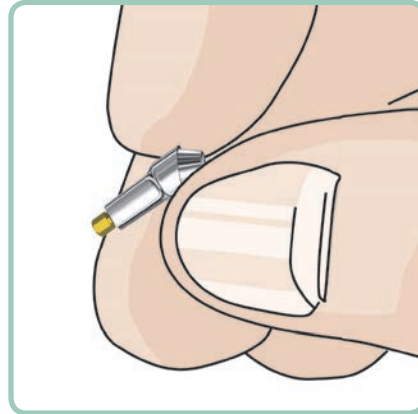
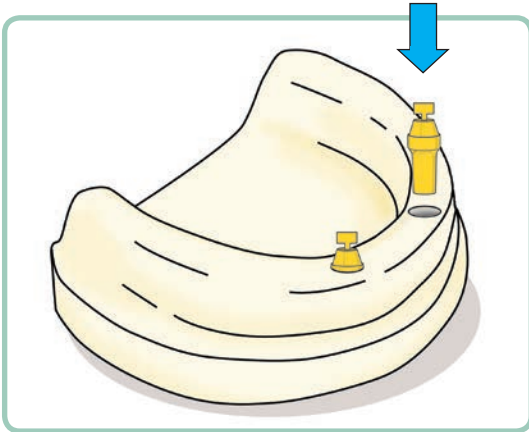

9.1 After the healing of soft tissues, take the impression with the conventional indirect technique using Standard transfers, send the impression to the lab and pour the dental cast (par. 1 and 2 of the prosthetic procedure). Plan the prosthetic restoration and select the appropriate abutments for screw-retained prosthesis according to the thickness of gingival tissues and inclination of implants, using the try-in abutments kit Cat. 160-0001-04.

9.2 In case of **360° angled abutments for screw-retained prosthesis**, the procedure for permanently fixing the hexagon to the abutment body is like the one for **LEONE 360° anatomical abutments** (points 4.3 - 4.11 of the prosthetic procedure). Please remember that the abutments need to be secured on the dental cast by applying a sufficient number of percussions. Deliver the dental cast and the selected abutments to the dental office.

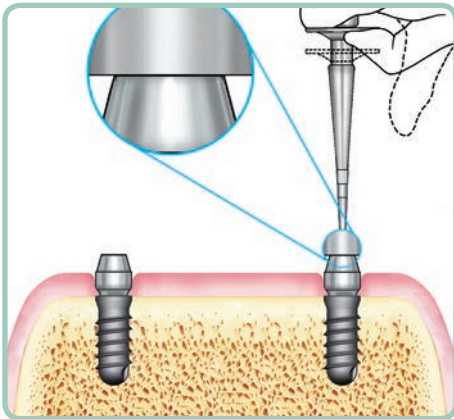

9.3 After the removal of the healing caps (point 7.5 of the surgical procedure), rinse and dry the implant's inner side, seat the abutments into the implants and apply an impulsive force onto the abutments' heads. To get a permanent connection of **straight abutments 2 consecutive percussions** with the proper abutment beater are recommended; on **angled abutments perform 5 consecutive percussions**.

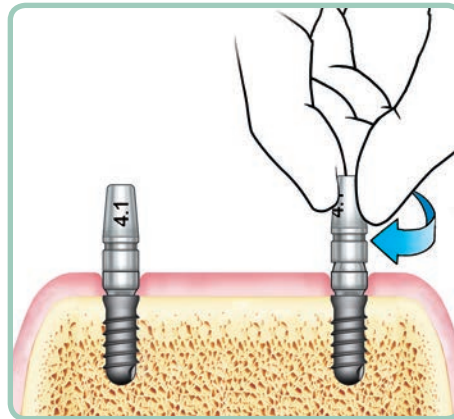

9.4 IMPRESSION TAKING ON ABUTMENT LEVEL
Hand-tighten the proper transfers for abutments onto the corresponding abutments all the way down.

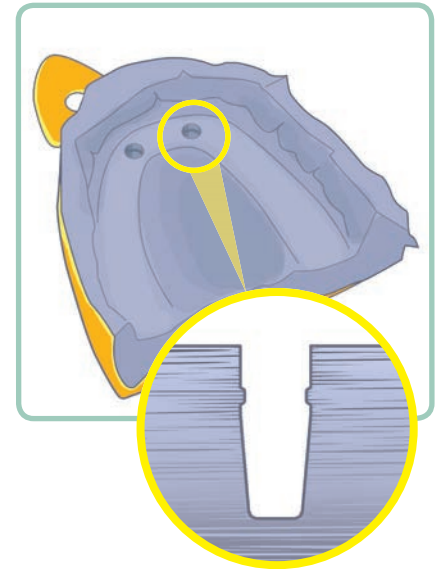

9.5 Take one-stage impression by using proper material and technique (a polyether material is recommended). The transfer's shape allows an easy removal of the impression. The transfers remain on the abutments, while the negative reproduction of their shape is created in the impression material.

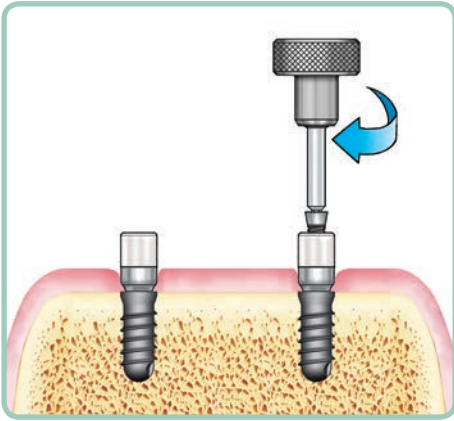

9.6 Unscrew the transfers by hand from the abutments, deliver the impression and the transfers to the lab and place the protective caps onto the abutments. The caps, included in the package of the transfers, are connected to the abutments with the standard connecting screws using the specific adapter Cat. 126-0002-00 mounted onto the hand screwdriver Cat. 156-1001-01. In case of pre-existing prosthesis, relieve it adequately corresponding to the abutments, so that it may be put in place with no pre-contacts.

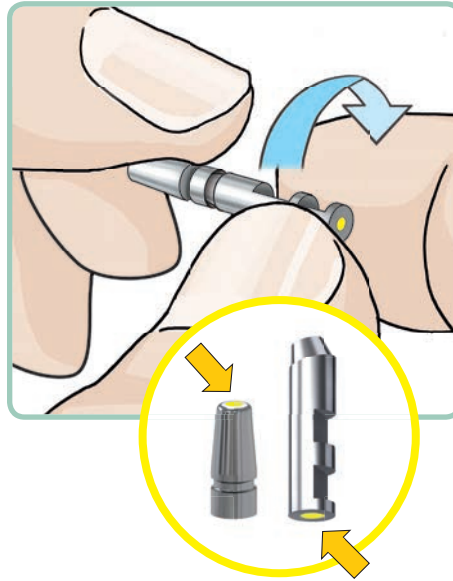

9.7 After checking the correct colour coding, screw the abutment analog into the relevant transfer all the way down.

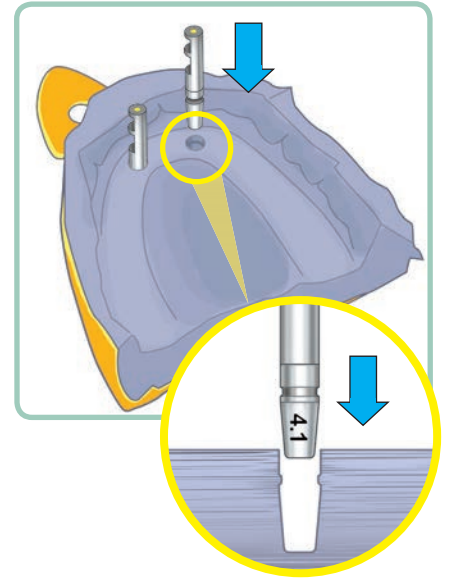

9.8 Reposition the transfer coupled with the analog into its seating inside the impression. The specific shape of the transfer allows to easily perceive when a complete insertion is achieved.

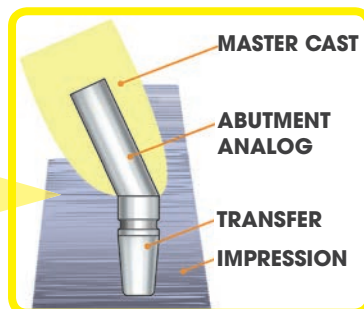
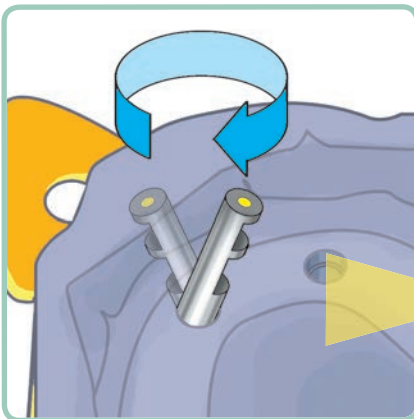

9.9 In case of angled abutment analog, the symmetrical geometry of the transfer allows to rotate the ensemble analog+transfer inside the impression; this way it is possible to determine the best angular position for pouring the cast. Rotate clockwise to prevent parts from unscrewing.

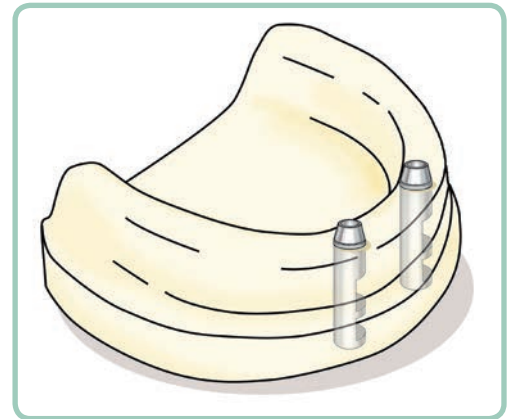

9.10 Pour a new master cast with the embedded abutment analogs. The use of a class 4 hard plaster is recommended.



a) RESTORATION WITH A TRADITIONAL BAR

9.11a In case of restoration with a traditional bar (i.e. Dolder bar), standard burn-out copings may be used.

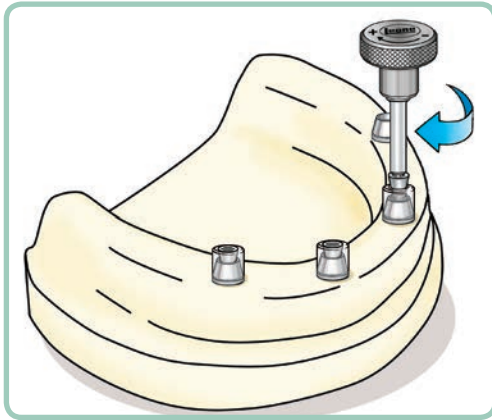

9.12a Connect the copings to the abutment analogs with the standard connecting screws using the specific adapter Cat. 126-0002-00 mounted onto the hand screwdriver Cat. 156-1001-01. Do not overtighten the screws on the standard burn-out copings.

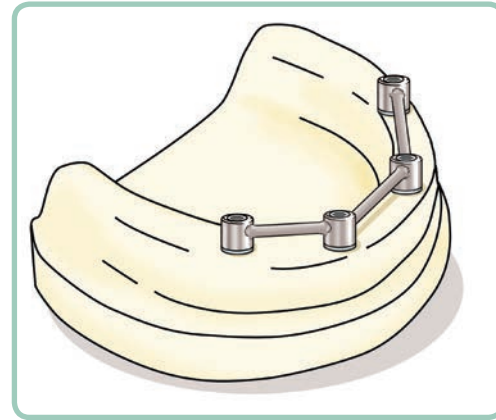

9.13a Fabrication of the bar with different options:

- 1) use of standard burn-out copings;
- 2) CAD-CAM procedures.

When the bar is ready, make a new denture with a proper seating and proper attachments for the bar or adapt the pre-existing one. Send the prosthesis to the dental office.

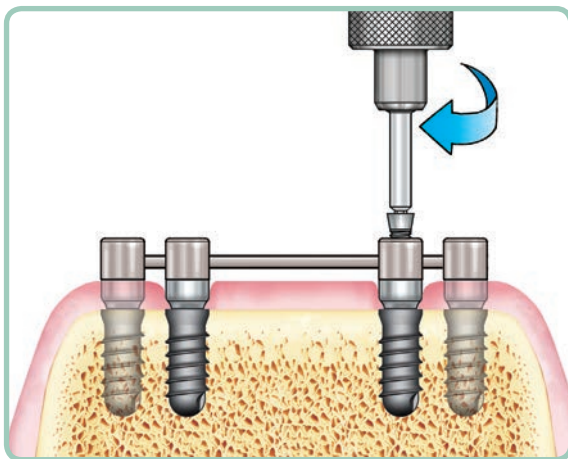

9.14a After the removal of the protective caps, seat the bar and fix it onto the abutments with the connecting screws.

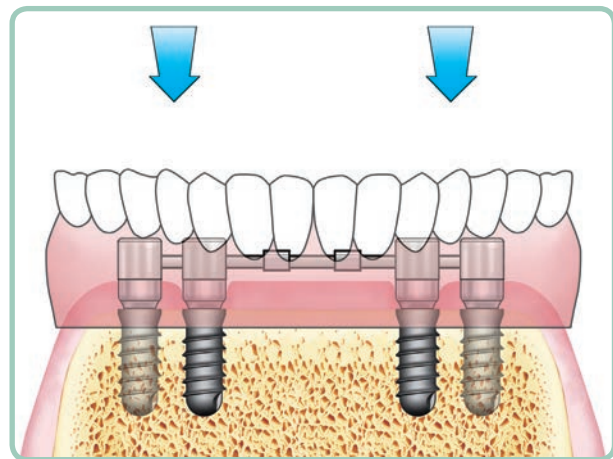

9.15a Clasp the prosthesis to the bar with the proper attachments.



b) RESTORATION WITH A SCREW-RETAINED PROSTHESIS



9.11b In case of restoration with a milled bar or a screw-retained bridge, high burn-out copings, titanium copings or long waxing screws Cat. 126-0020-05 may be used, which allow during framework's modelling, the preparation of a channel of adequate dimensions for the seating of the connecting screws.

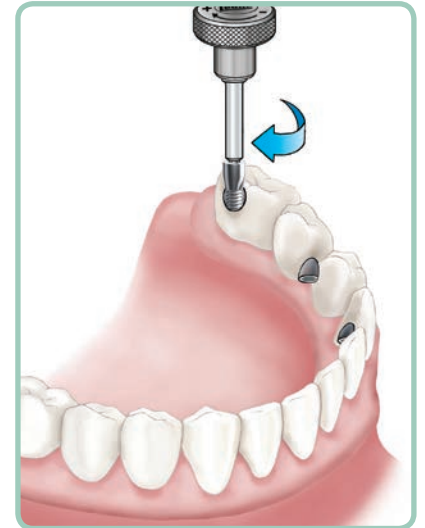
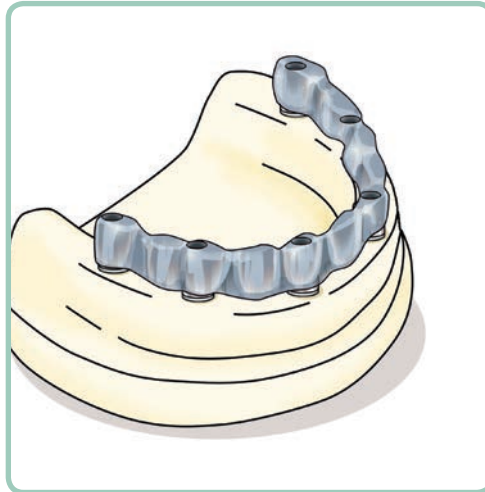
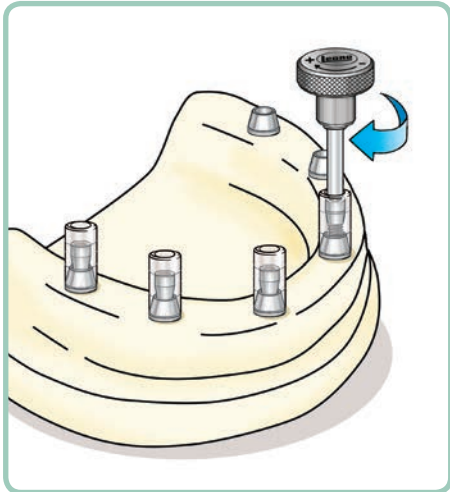

9.12b In case of high burn-out copings, connect the copings to the abutment analogs with the high head connecting screws, using the specific adapter Cat. 126-0002-00 mounted onto the hand screwdriver Cat. 156-1001-01.

9.13b Fabrication of the framework with a traditional technique or CAD-CAM technique. It is possible to choose among different accessories:

- 1) use of high and/or standard burn-out copings;
- 2) use of titanium copings;
- 3) use of long waxing screws.

Prepare the final restoration. Send the prosthesis to the dental office.

9.14b After the removal of the protective caps, seat the prosthesis and fix it onto the abutments with the connecting screws.

Use of titanium copings

There follows an example for the use of the titanium copings: fabrication of a screw-retained provisional prosthesis for an immediate loading procedure.



Titanium copings screwed onto the abutments seated on the dental cast and wax-up of the reinforcing framework.

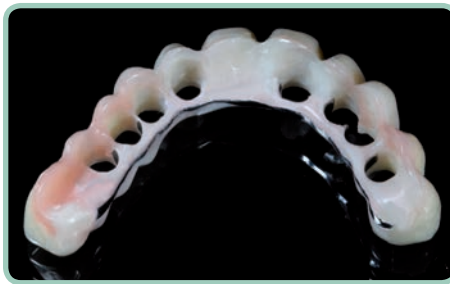

Provisional prosthesis relieved in the area of the copings.



Provisional prosthesis seated on the dental cast: if necessary the height of the copings can be reduced accordingly.



In the mouth: fixing of the prosthesis to the titanium copings screwed onto the abutments in order to achieve a passive fit of the structure.



Titanium copings bonded to the finished provisional prosthesis.



Screw-retained provisional prosthesis in the mouth.

Use of welding units (syncrystallization technique)

The titanium copings, due to their adequate thickness, can be splinted together with a titanium wire through a welding process which can be performed intraorally or on the dental cast. Intraoral welding, performed with specific welding units using a technique called “syncrystallization”, allows rigid splinting of implants with no risk of overheating of the peri-implant tissue and ensures a perfect passive fit of the structure. By rigidly splinting the implants together, this technique improves the predictability of immediate loading procedures.

ALL-ON-FOUR OR ALL-ON-SIX PROSTHESIS

In case of severely atrophic edentulous jaws, in order to avoid complex surgical procedures, there exists the possibility to reduce the number of implants – usually to 4 or 6 – by tilting the two distal implants so that their implant heads emerge as posterior as possible. In this way a fixed, screw-retained prosthesis is produced, and if the preconditions are met, it may be associated with an immediate loading procedure.

The high stability of the Morse taper connection and the availability of angled abutments with high inclination make the **LEONE** implant system ideal for this type of solution.

To facilitate impression taking on not perfectly parallel abutments, specific transfers for pick-up technique have been developed.

Using pick-up transfers, the points 9.4. – 9.8 of the prosthetic procedure need to be replaced by the following steps:

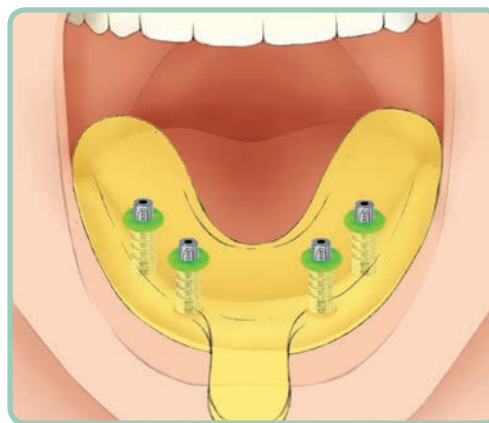
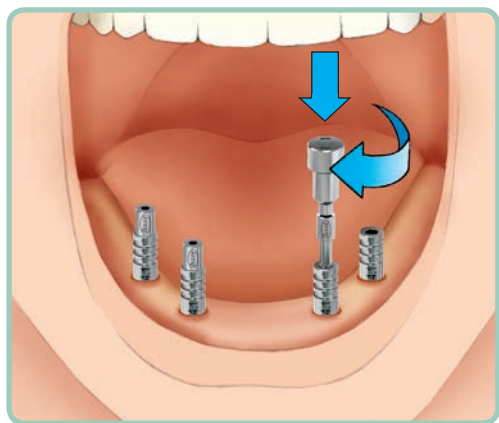

IMPRESSION TAKING ON ABUTMENT LEVEL WITH PICK-UP TECHNIQUE

Place the proper diameter pick-up transfers onto the abutments and tighten the pick-up screws Cat.126-0012-01 all the way down using the specific short screwdriver Cat.126-0002-01.

Use a custom open top impression tray and verify that the screw heads protrude through the openings or expose the screw heads before the impression material has set.

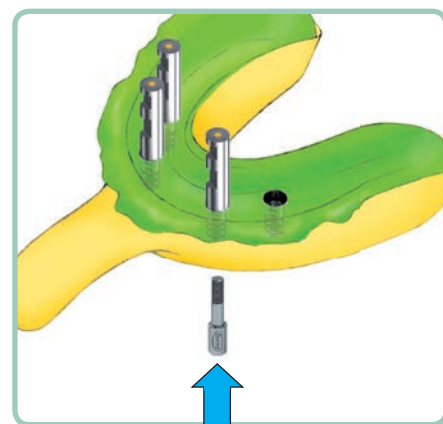
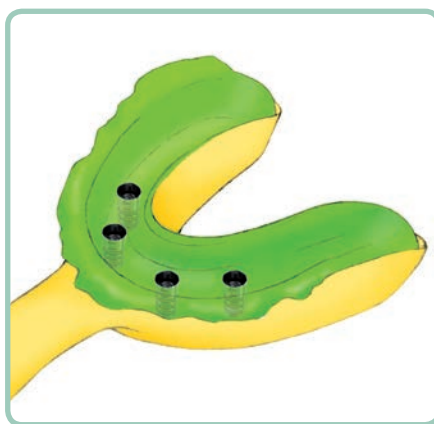
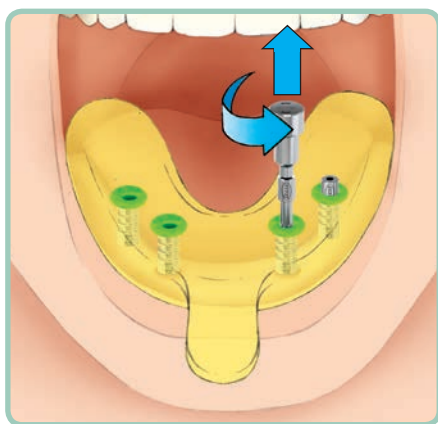

One-step impression taking using suitable materials and techniques. After the impression material has set, unscrew the pick-up screws and remove them from the transfers.

Remove the tray from the mouth: the pick-up transfers are kept in the impression. Deliver the impression and the pick-up screws to the laboratory. Place the protective caps onto the abutments (see point 9.6).

Place the proper diameter abutment analog onto each transfer and tighten the pick-up screws. Verify that the abutment analogs are completely seated onto the transfers.

10) MULTITECH ABUTMENTS: DIRECTIONS FOR USE



Always verify that the soft tissue conditioning allows for correct seating of the customized abutment into the implant. If the burn-out coping is used for the wax-up of the customized portion, use the healing cap of the Large prosthetic platform for soft tissue conditioning.

CAUTION: *in case the platform of the customized abutment is wider than the Large healing cap, a specific conditioning of the soft tissue shall be provided.*

In case of **360° angled MultiTech abutments**, the procedure for permanently fixing the hexagon to the abutment body is like the one for **LEONE 360° anatomical abutments** (points 4.3 – 4.11 of the prosthetic procedure).

Fabrication of the customized abutment portion:

WITH CAD-CAM technology by taking a scan of the seated abutment on the dental cast and modelling of the customized abutment portion with a specific software. The fabrication is performed in the laboratory with a specific **Computer-Assisted Machine** or by a specialized production centre upon the receipt of the data file.

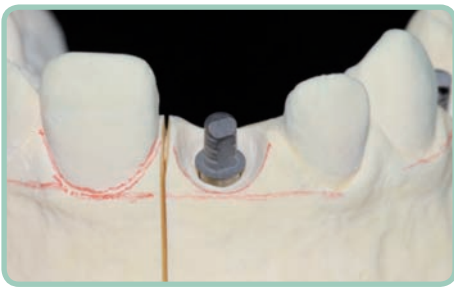

Dental cast and MultiTech

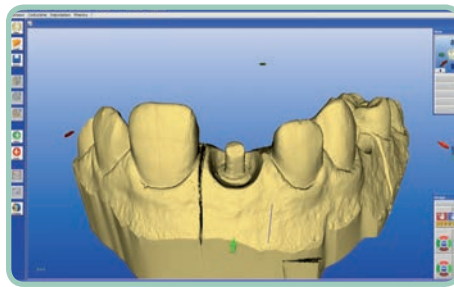

Scanning

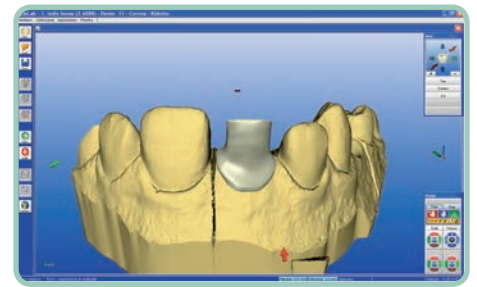

Design

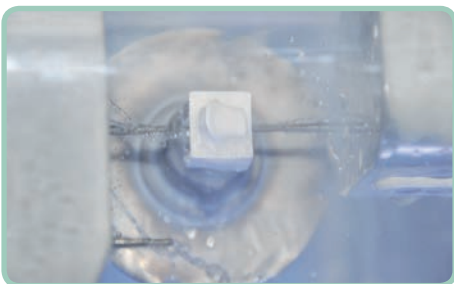

Milling with the CAM unit



A sintering process is required when zirconia is used

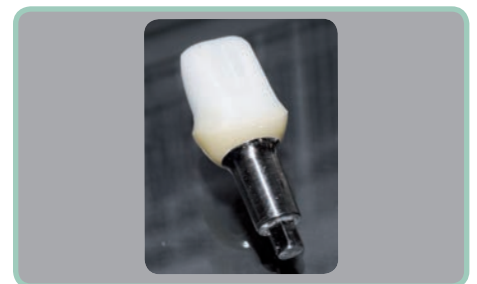

Bonding of the customized portion onto the MultiTech abutment. In case of zirconia, NIMETIC CEM (3M Espe) or MULTILINK HYBRID ABUTMENT (Ivoclar Vivadent) is recommended



Dental cast and MultiTech

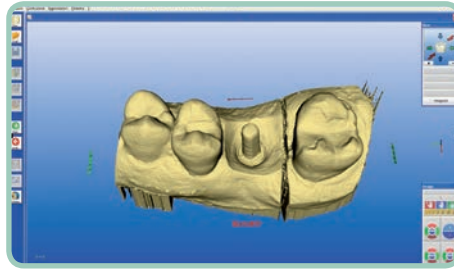

Scanning

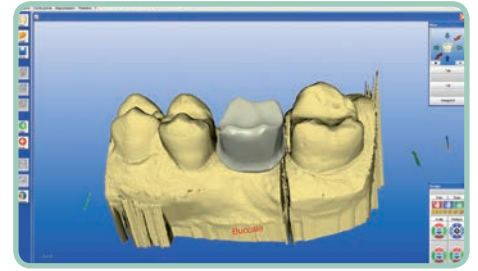

Design

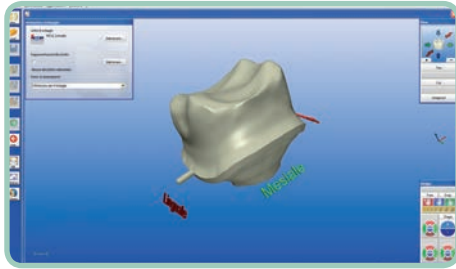

Delivery of the project to the milling center



Receipt of the customized portion



Bonding of the customized work onto the MultiTech abutment. In case of metal, NIMETIC CEM (3M Espe) or transparent composite cement is recommended

WITH THE TRADITIONAL METHOD by using a pre-fabricated burn-out coping placed on the abutment, adjustment of the coping, modelling with wax and/ or acrylic and fabrication of one customized abutment portion through casting.



Dental cast and MultiTech



Seating of the burn-out coping on the MultiTech abutment

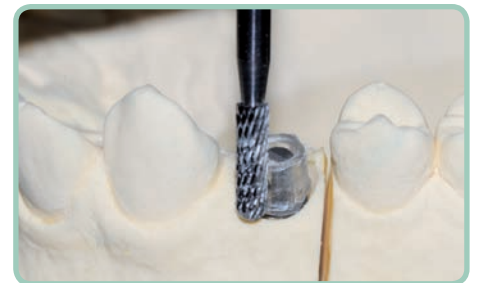

Adjustment of the burn-out coping



Waxing

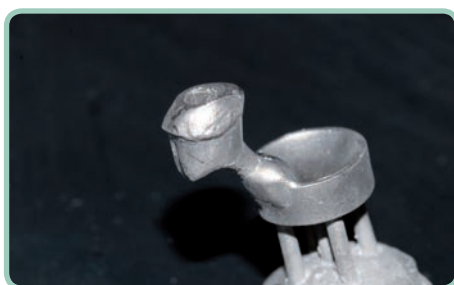

Casting

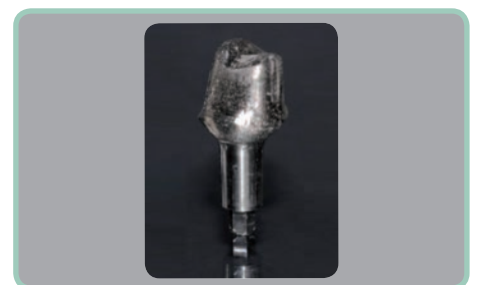

Bonding of the customized portion onto the MultiTech abutment. In case of metal, NIMETIC CEM (3M Espe) or transparent composite cement is recommended



11) INTRAORAL SCANNING AND USE OF THE TI-BASE ABUTMENTS



Digital impression taking

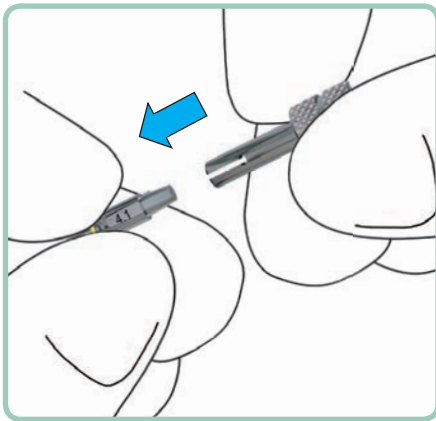

11.1 Connect the specific positioner to the top of the scan post.

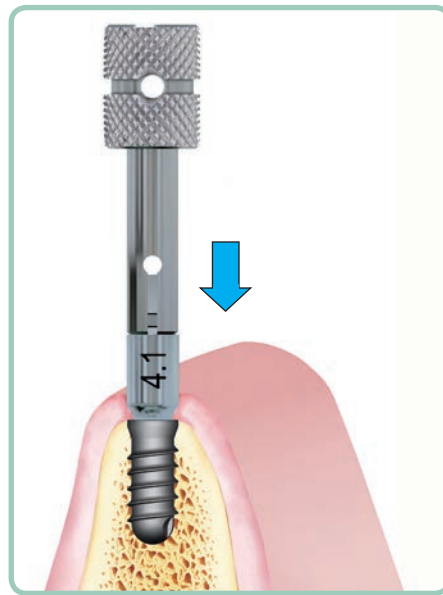

11.2 Place the scan post into the implant using the positioner: engage the hexagon and exert pressure on the scan post in order to verify complete seating.



11.3 Remove the scan post positioner.

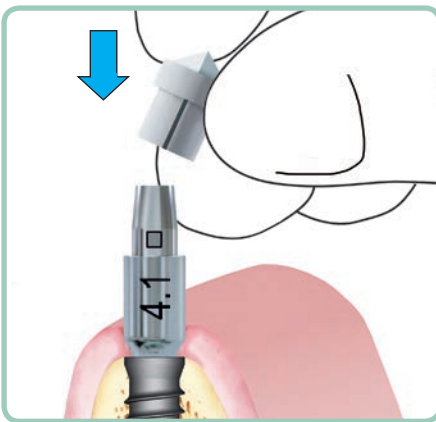

11.4 Select the proper scan body (white or grey) depending on the intraoral scanner type. Place the scan body onto the scan post by aligning the markings and pushing it all the way down. Verify complete seating and that the markings on the scan body and the scan post line up.

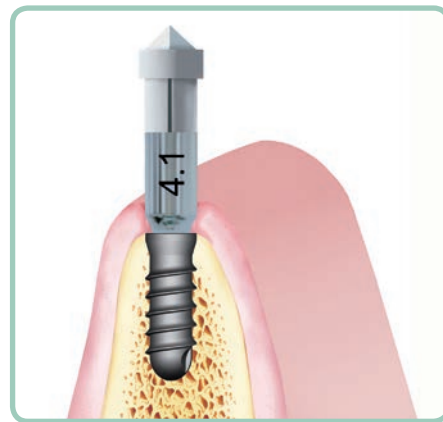

11.5 Take the digital impression with the intraoral scanner. The procedure can also be carried out on the dental cast, by seating the scan post coupled with the scan body into the analog and digitizing the dental cast with a specific laboratory scanner. For further details on the procedure, please refer to the instructions associated with the QR code.

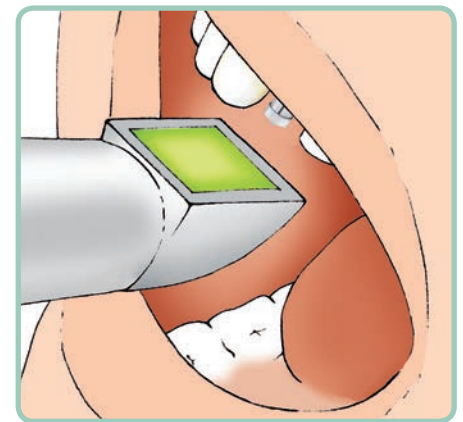

Fabrication of the prosthetic restoration

For information about the fabrication of the restoration using Ti-Base abutments, please refer to the instructions associated with the QR code.

CAUTION: if a 3,3 mm diameter Ti-Base abutment is used, use the healing cap of the Large prosthetic platform for soft tissue conditioning.

The continuous and rapid evolution of digital technology implies a constant updating of the procedures as well as of the associated components. Please refer to the online version of the prosthetic procedure and to the associated explainer videos for the relevant updates.

12) TEMPORARY ABUTMENTS: APPLICATION PROCEDURE

LEONE temporary abutments are prosthetic accessories designed to support an implant-retained temporary prosthesis.

The abutments are designed to be held in the oral cavity for a limited period of time, **no longer than 6 months**.

LEONE temporary abutments are made of an ultra-polymer - a polymer with extremely high mechanical characteristics - highly biocompatible and easily preparable. This material is radiotransparent and can be sterilized in the autoclave at 135°C (275°F).

The abutments can be utilized with both the direct and indirect techniques and, therefore, can be prepared directly in mouth or in the laboratory.

The temporary prosthetics must always be out of occlusion in order to reduce the effect of the masticatory load.

We do not suggest using Ø3,3 temporary abutments for single prosthetic rehabilitations.



POSITIONING OF THE TEMPORARY ABUTMENT



12.1 Cylindrical temporary abutment made of PEEK.

Notice that it has the same implant-abutment connection design as the definitive titanium abutments.

12.2a Connection of the abutment to the appropriate abutment handle, paying special attention to engage the internal hexagon.

Subsequent preparation of the abutment. We suggest to use coarse-grained diamond burs; we also suggest to use the burs at a low speed and with little pressure. Alternatively, it is possible to prepare the abutment directly in the patient's mouth.



Removal of the abutment from the handle by using the special push-button. Any refinement to the abutment can be made on the dental cast or directly in the patient's mouth.

If preparing the abutment on the dental cast, please refer to the paragraph in the Prosthetic Procedure entitled "Indirect technique: preparation of the abutment".

12.2b When using an angled temporary abutment, it is necessary to create a step parallel to the axis of the cone. The specific beater will be placed on the step for a correct percussion of the abutment on the implant.

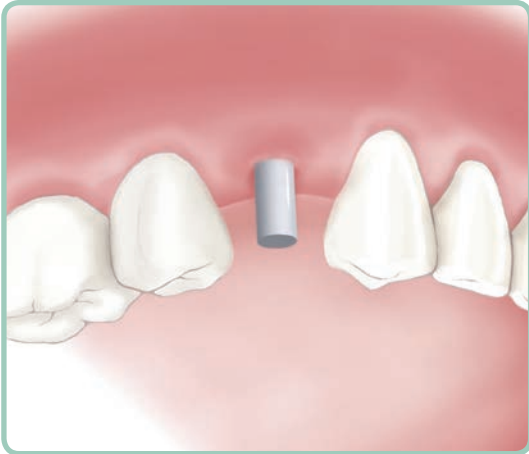

12.3 Insert the temporary abutment in the implant, paying special attention to engage the internal hexagon.

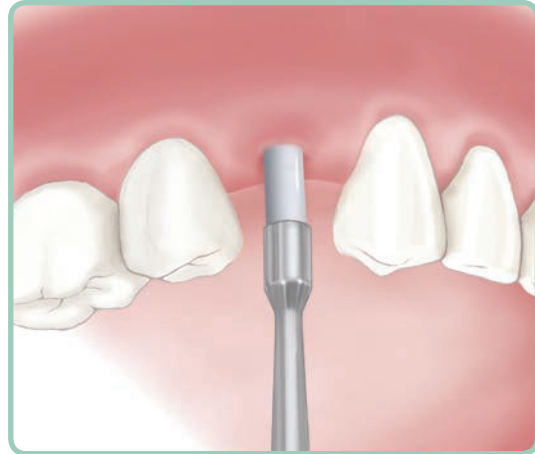

12.4a Apply an impulsive force on the abutment along the longitudinal axis of the implant with the special abutment beater. We advise using two consecutive percussions.

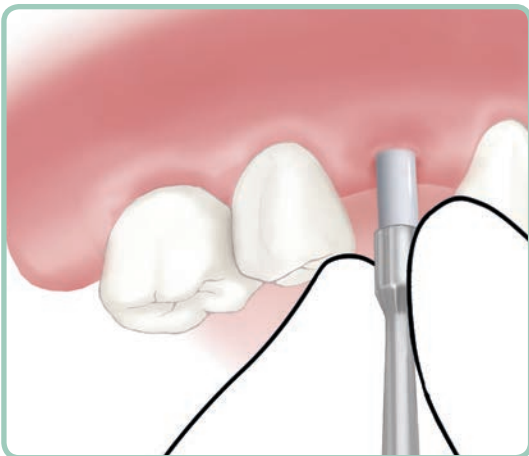

12.4b CAUTION: *due to the nature of the material, the seating tip of the abutment beater may tend to slide during the application of force. We suggest, in this case, to support the tip with your fingers during the operation.*

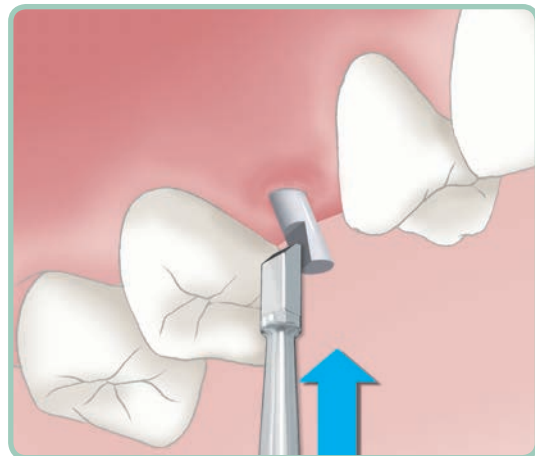

12.4c When using an angled temporary abutment, tapping must be performed with the special flat seating tip, Cat. 156-1008-06, taking care to incline the instrument along the implant axis.

We recommend using temporary cement to secure the temporary prosthesis to the abutment.

CAUTION: *do not cement the temporary crown extra-orally, but always attach it to the abutment after the abutment has been connected to the implant.*

REMOVAL OF THE TEMPORARY ABUTMENT

If you intend to reposition the abutment after removing it from the implant, pay special care to avoid distortion during removal. First, remove the temporary prosthesis from the abutment with a crown-removal instrument.

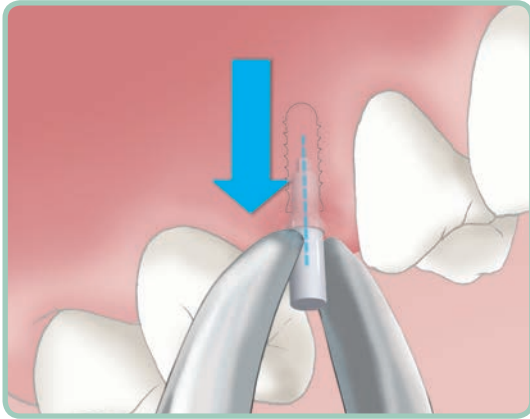

12.5a Using extraction pliers or other pliers with curved and gripping jaws, grasp the emergence of the abutment as close as possible to the gingival margin and apply a pulling force. We suggest to protect the opposing jaw by placing a finger between it and the abutment.

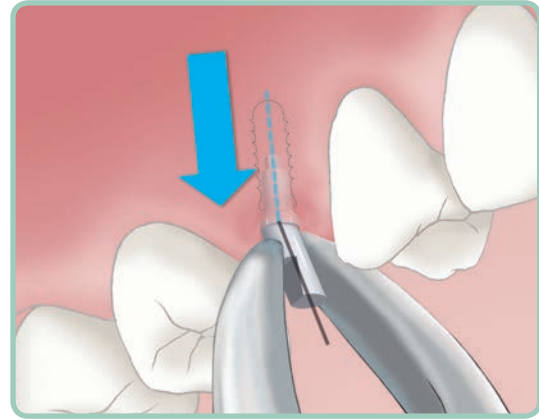

12.5b When using an angled temporary abutment, the pulling force should be applied along the implant axis and not along the emergence of the abutment.

CAUTION: *it is important to avoid any twisting motion, even slight, in order to avoid damaging the apical hexagon.*

As an alternative to the procedure above, after removing the temporary restoration, you can remove the abutment by simply rotating or bending it. In both cases however, the abutment will be permanently distorted and impossible to reuse. To better illustrate, the following is the removal procedure with bending.

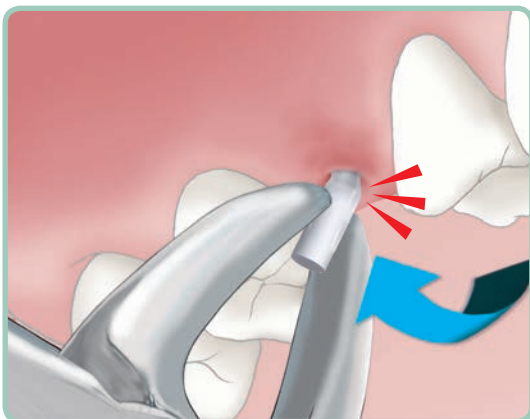

12.6a Using the extraction pliers, grasp the emergence of the abutment as close as possible to the gingival margin and bend continuously. Deform the abutment until you can appreciate a loss of tightness of the conical connection.

CAUTION: *it is important that the abutment is bent with a continuous movement and not with an alternate movement.*

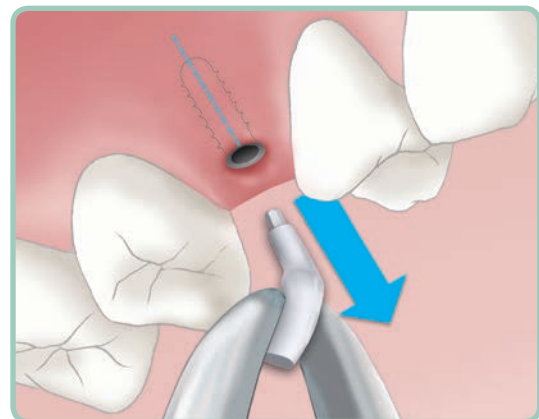

12.6b Once the abutment is sufficiently bent, remove it with a simple pull. We suggest to protect the opposing jaw by placing a finger between it and the abutment.

INSTRUCTIONS FOR THE REMOVAL OF LEONE ABUTMENTS

The Leone abutments are characterized by a self-locking taper connection that, fully seated, determines a very strong connection with the dental implant (cold welding). Occasionally there may be cases where you want to replace an abutment fixed to the implant with a new one of a different geometry, basically because of the necessity to change the type of prosthetic restoration. For use exclusively in cases like these an instrument for the removal of **LEONE** abutments has been developed, consisting in specifically modified extraction forceps. The instrument is based on the so-called “wedge effect”, whereby an extraction force is developed as a result of the abutment’s geometry, in particular its transmucosal portion.

CAUTION:

for the proper functioning of the instrument the transmucosal portion of the abutment needs to be totally intact and not modified by the prosthetic preparation.

Two different instruments are available, one for abutments of the Standard prosthetic platform and one for the abutments of the Large prosthetic platform. Both are universal instruments in regard to the connection size, i.e. they can be used indifferently for Ø3,3 – Ø4,1 – Ø4,8 mm abutments.

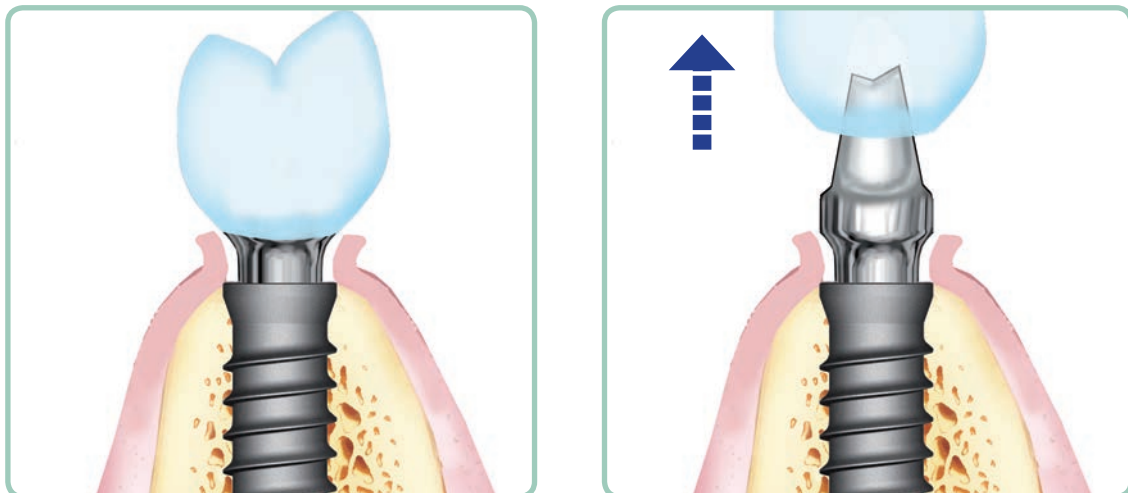

13.1 In order to use the instrument expose the top of the implant collar, preferably by means of a full-thickness flap. This way the device may get in contact with the top of the implant collar. This also allows for perfect visibility of the area and overcomes any potential obstacle associated with the soft tissue. For the proper functioning of the instrument remove, if present, the crown from the abutment, to avoid that it may prevent the beaks of the forceps from closing properly.

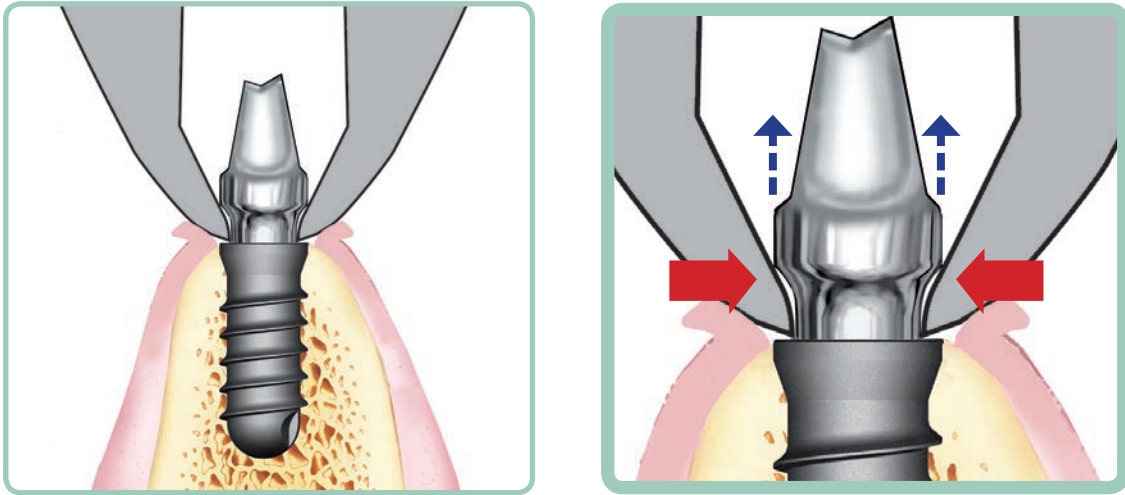

13.2a, b Place the beaks of the instrument at the level of the transmucosal portion of the abutment and in contact with the top of the implant collar; then, by closing the beaks, an extraction force is applied on the abutment. The abutment is pushed outward due to the “wedge effect”, thanks to the specific angulation of the inner surface of the beaks.

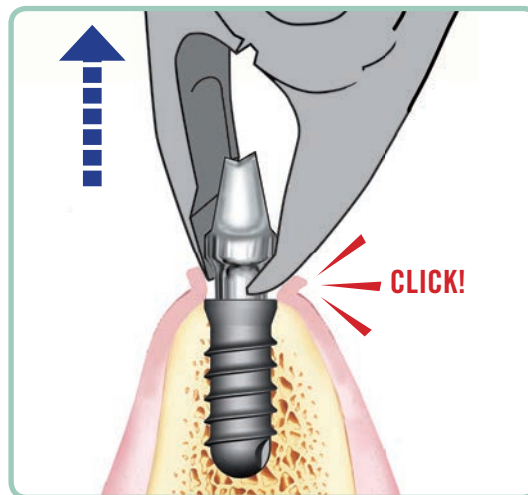

13.3 Once established a firm grasp, continue to compress the forceps and push down towards the top of the implant collar: in this way the abutment is released from the implant with a clicking sound, due to the “wedge effect”.

If this procedure is unsuccessful, once the beaks are in contact with the top of the implant collar, use a simultaneous pulling and twisting motion to promote removal.

During this procedure it is essential to ensure adequate protection for the opposing jaw, as the unlocking and removal of the abutment occur quite suddenly and the instrument could crash onto the opposing teeth.

CAUTION: *the described procedure causes damage to the abutment's taper connection which can no longer be used. The abutment needs to be replaced by a new one.*

SURGICAL and **PROSTHETIC** procedure

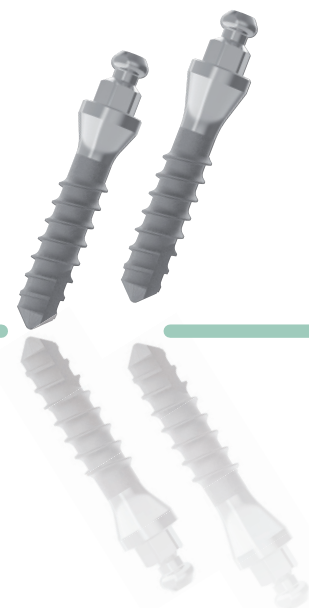

for



monoimplants
for overdenture O-ring



DISCLAIMER

The Surgical and Prosthetic Procedures related to the use of the Leone products for Monoimplants for O-ring overdenture described in the following pages are intended for Professionals experienced in dental implant techniques.

In case of lack of basic notions, we suggest to attend specific courses in order to reach a high level of knowledge and practice in the use of implants. The instructions for use of the products described below represent a sort of standard instructions that have to be adjusted to the individual needs and to the particular situations that may occur on the basis of the manual ability, the experience and diagnosis effected by the legally qualified medical operator. It is not ascribed to the manufacturer the duty of monitoring the procedures of use of the product. A correct and appropriate use of the instruments and products related to the LEONE Monoimplants for O-ring overdenture shall completely be reverted to the clinician. The surgical procedure hereunder described is merely indicative as any single treatment case is assigned to the experience of the operator. As every medical operator well knows, a correct procedure and a perfect manufacture of the prosthesis may sometimes be followed by not satisfactory results owing to particular situations not imputable to responsibility of the dental operator or the manufacturer.

TREATMENT PLANNING

Indications

The Leone Monoimplant for O-ring overdenture therapy is indicated in the treatment of the TOTAL LOWER EDENTULISM.

Contraindications

For contraindications and side effects read the instructions for use enclosed in the package of each product and available in our web site www.leone.it.

PREOPERATIVE EXAMS

Before starting the surgical intervention, the patients have to be subjected to a series of exams; any single case has to be evaluated by the clinician.

Anamnesis

It is the first approach to the patient and it represents a fundamental tool to recognize both risk factors and contraindications. Moreover, anamnesis allows for the evaluation of patient's expectations, priorities, degree of compliance and motivation.

Anamnesis can help in evaluating the need for extra exams in addition to the routine ones (when the presence of pathologies that were not reported by the patient is suspected) and when particular situations drive to deem a complete medico-surgical exam necessary.

Objective exam

It consists of:

- inspection of the periodontal tissues, of the oral mucosa and of the teeth along with an initial evaluation of the occlusal relationships (skeletal Class, characteristics of the opposing arch and related potential problems, type of occlusion, interarch distance), of the presence of parafunctions, of the degree of oral hygiene, of the aesthetic conditions, of the morphology of the edentulous crest and the space available for the replacement of the prosthesis.
- palpation of the soft tissues and implant sites with a first evaluation of the bone morphology and thickness.
- a complete periodontal probing for the appraisal of the absence of both gingivitis and pockets.

Radiographic exams

PANORAMIC RADIOGRAPH: frequently, this radiograph enables to appraise bone height and the relationships between implant site and adjacent structures, such as mandibular canal, etc.

It is also possible to identify concavities and ossification defects due to previous tooth extractions.

INTRAORAL RADIOGRAPH: it is very helpful for the determination of the apico-coronal availability of bone.

LATERAL CEPHALOGRAM: it is useful for the determination of the mandibular symphysis.

COMPUTERIZED TOMOGRAPHY: it is advisable to remind that previous radiographic exams provide two-dimensional images which do not give information on bone thickness. In order to obtain this useful information a computerized tomography is necessary: it provides three-dimensional images, thus allowing for an accurate evaluation of bone morphology and, sometimes, bone density.

Instrumental or laboratory exams

When necessary, in cases where a pathology is suspected on the basis of anamnesis or clinical records.

MONOIMPLANT SELECTION

The dimensions (implant length and transmucosal neck height) of the monoimplants to be seated are determined by the following factors:

1. amount of bone available
2. characteristics of the implant site
3. thickness of the soft tissues in the areas involved.

Further and particular individual situations must be evaluated by the Dentist or the Dental Surgeon.

Do not place monoimplants in the upper arch.

A template Cat. 156-2003-01 (page 50) is available that shows all Leone monoimplants GH3 in actual dimensions, with dimensions increased by 10% and increased by 25%, to match possible distortions created by the instrument for radiographic examinations (CT and panoramic radiograph). Superimpose the template to the radiograph in order to select the monoimplant in relation to the quantity of bone available.

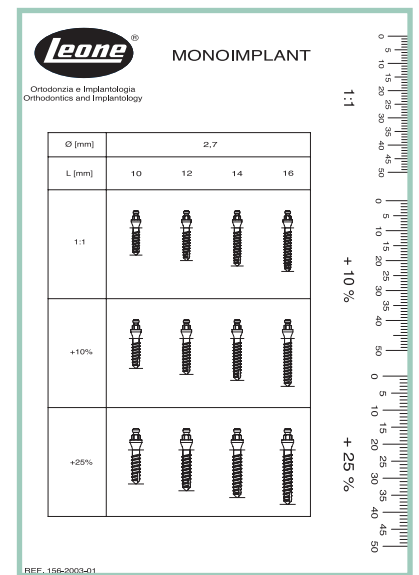

To simplify the surgical operation, an instrument organizer Cat. 156-0017-00 (page 49) was conceived by LEONE to sterilize and hold the necessary instruments on the operating table. The organizer must be sterilized before use.

The sterilization must be performed as follows:

- wrap the organizer into a sterilization bag as requested by the manufacturer of the sterilizing machine.
- autoclave at 121° (250°F) for 20 minutes.
- remove the organizer from the autoclave and leave it cool inside the bag.
- leave the organizer inside the bag to preserve sterility.





1) PREPARATION OF THE IMPLANT SITE

The typology and the access to the surgical site shall be selected by the professional according to the clinical-morphological parameters. Schematically and with illustrative purpose only, the following steps for the preparation of the implant site are illustrated.

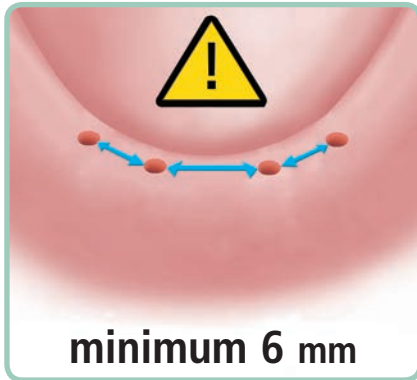

1.1 After adequate treatment planning, clearly mark the locations where the monoimplants must be inserted with a marker pen or a surgical template.

The Leone monoimplants must only be inserted in the mandible, at the level of the mandibular symphysis, located in the area between the two foramina.

The number of monoimplants required to adequately support a removable prosthesis is 4. The minimum required space between each implant and the next is 6 mm. This will allow the correct positioning of the micro housings.

The eventual inclination of every single implant shall not have to overcome 8° to the axis of parallelism. Make sure that the prosthesis is tissue borne and only implant retained. Avoid any implant-prosthetic load on the monoimplants since they have to act exclusively as a retentive element.

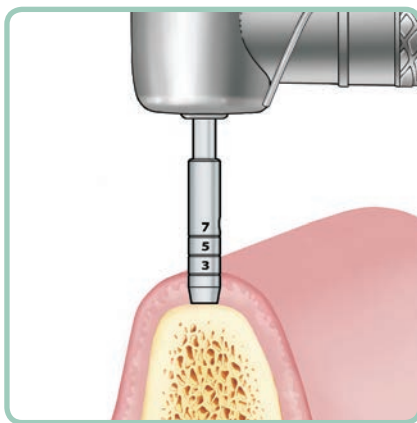

1.2a Flapless procedure

Punch the mucosa with the use of the special mucosa punch for handpiece (Cat. 151-2215-20) included in the organizer. Use the mucosa punch with the handpiece set to low speed (approx. 40 rpm). Use until bony tissue is met. For visual reference, as well as to determine the gingival thickness around the implant area, the three black lines clearly visible around the mucosa punch, at the heights of 3-5-7 mm, starting from the crest bone, may be used. Remove the mucosa punch and remove the tissue plug by using a small periosteal elevator.

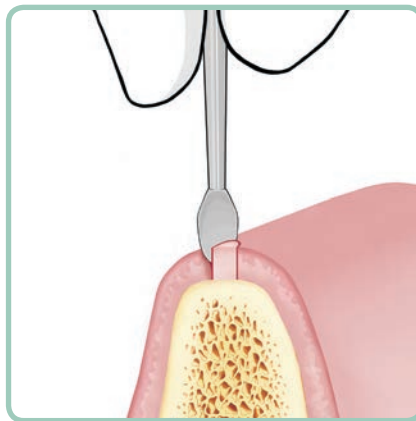

1.2b Flapping procedure

In case there are uncertainties on the condition of the crestal bone or the quantity of bone available, the use of the flapping procedure is advisable. Start with a scalpel incision of the soft tissues, then open the gingival flap for a clearer vision of the crestal bone: the osteotomy can now be performed.



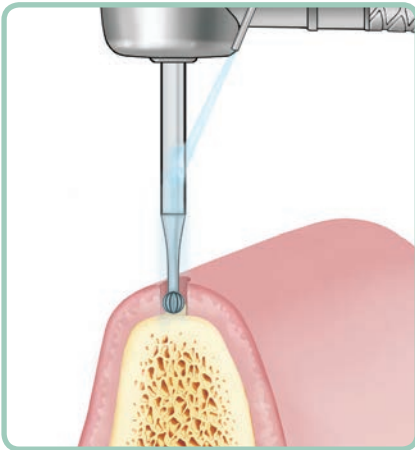

1.3 Once the gingival tunnel has been obtained, use the round bur Cat. 151-1934-01 included in the organizer, to mark the cortical bone for the subsequent pilot drill. Alternatively, it is possible to use the lance drill Cat. 151-1930-02, which is particularly suitable in case of narrow knife-edged ridges.

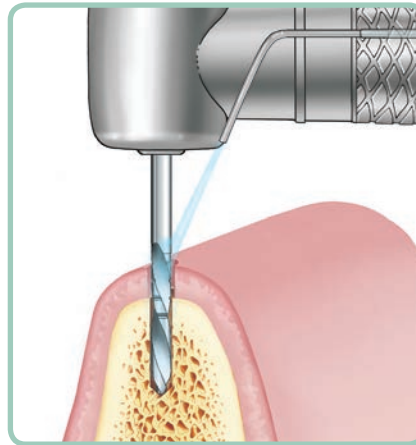

1.4 Place the \varnothing 2.2 mm pilot drill Cat. 151-2241-12, included in the organizer, in the track made by the round bur and drill the bone until the length of the desired monoimplant has been reached. The handpiece must be set to a limited speed of 800 rpm. Irrigate abundantly while using the pilot drill. Pay attention to the length of the monoimplant, to which the height of the soft tissues has to be added. The drilling depth can be checked on the depth marks on the drill:

- drills with 4 marks: 8-10-12-14 mm
- drills with 5 marks: 6.5-8-10-12-14 mm

Care must be taken to the length of the monoimplant to which the height of the soft tissues shall be added.

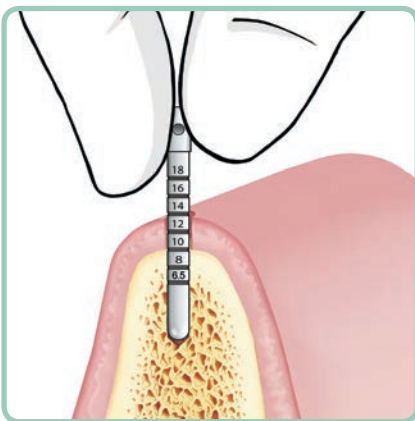

1.5 Insert the depth gauge Cat. 156-2002-00, included in the organizer, into the newly created implant site to check its depth, considering also the height of the soft tissues.

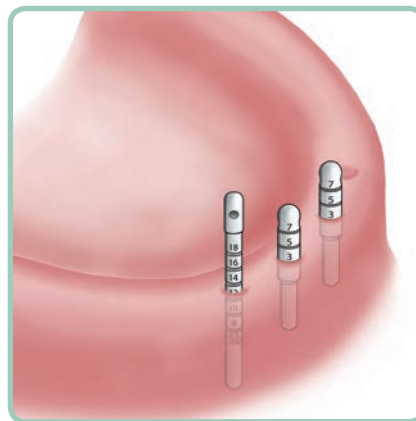

1.6 Repeat points 1.2 – 1.5 for the remaining three monoimplants, ensuring the maximum degree of parallelism among the surgical sites. Check the parallelism of the monoimplants using the measuring pins for gingival height Cat. 156-2004-00 and the depth gauge both included in the organizer; these may be inserted in the implant sites just drilled. The measuring pins may also be used at any other time to check soft tissue thickness.

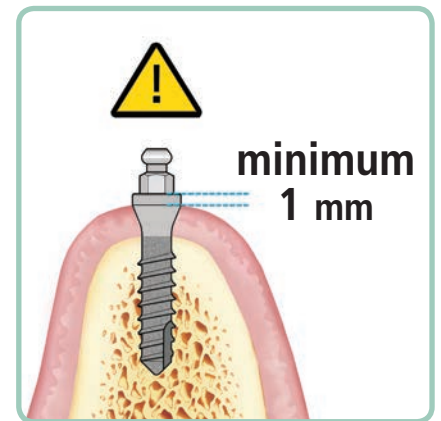

1.7 It is now time to choose the transmucosal neck height of the monoimplant. The head of the monoimplant must protrude from the gingiva by at least 1 mm to avoid a possible impingement of the micro housing on the patient's soft tissues.



2) LEONE MONOIMPLANT PACKAGING

The monoimplant is supplied with the micro housing in a sealed envelope that also carries the relevant product information.

2.1 THE PACKAGING

The packaging features a double protection to preserve the sterility of the implant subjected to a certified gamma x-ray process. A removable part of the label showing the information of the implant (see label symbols at page 125) is to be applied on the "Identity card" of the implant or on the clinical case sheet of the patient. A sterility indicator is present on the glass vial.



THE GLASS VIAL

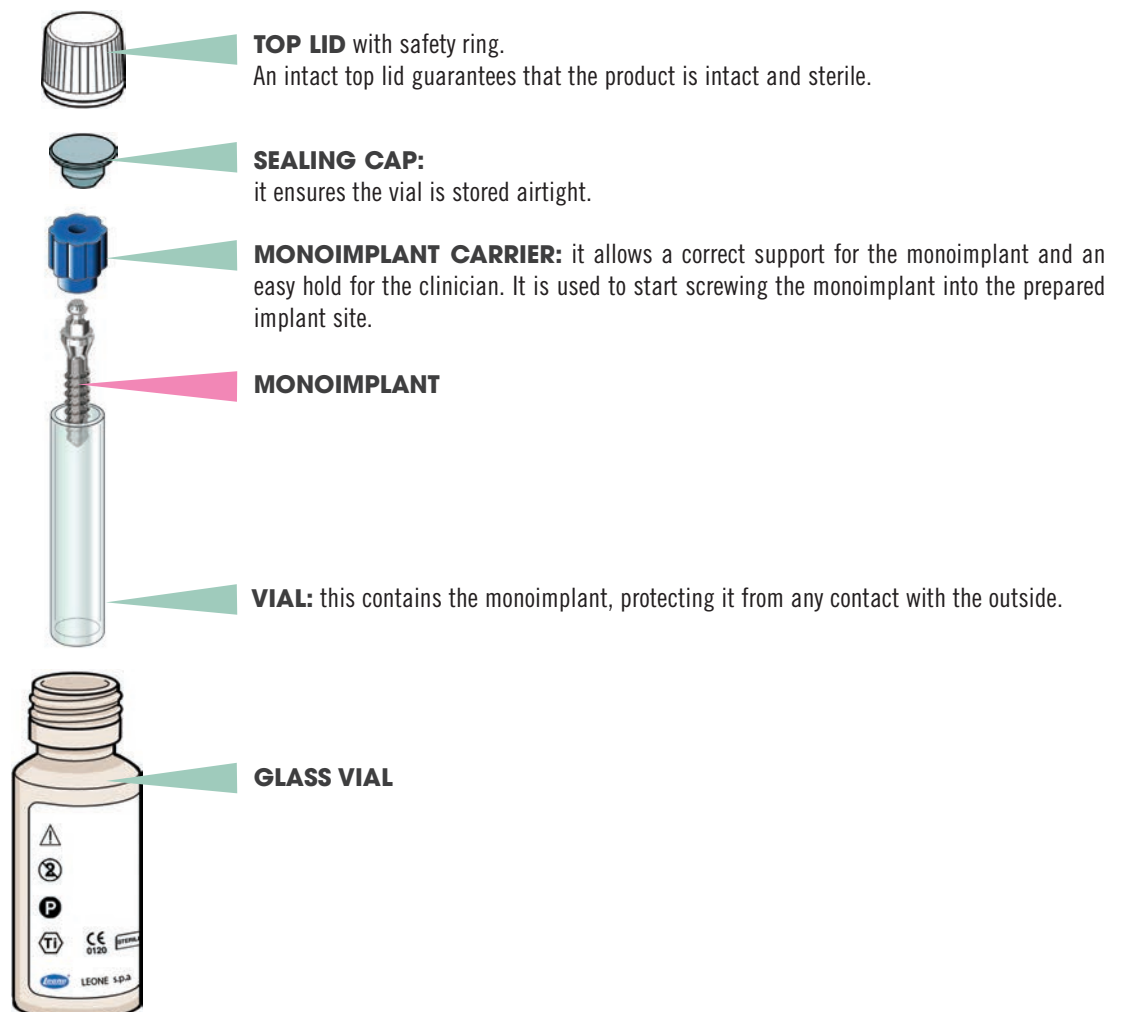

3) INSERTION OF THE MONOIMPLANT

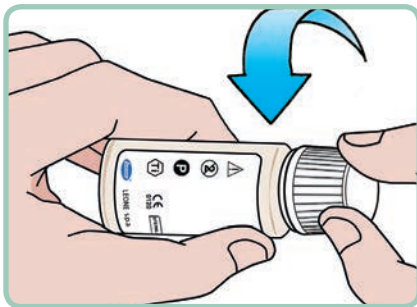

3.1 Unscrew the glass vial's top lid.

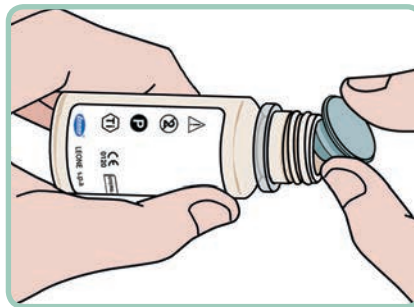

3.2 Remove the sealing cap.

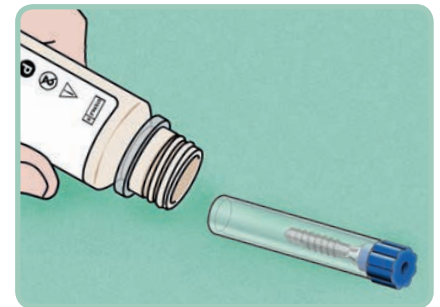

3.3 Extract the vial containing the monoimplant from the glass vial then lay it gently onto the sterile pad.

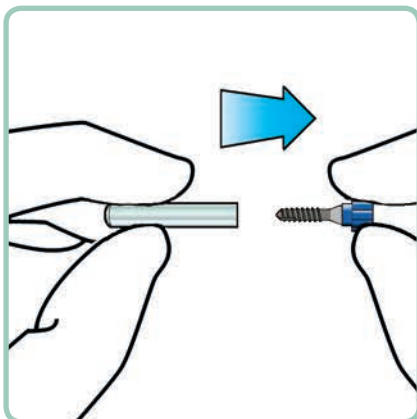

3.4 Hold the vial with one hand while gently pulling out the monoimplant with the other. Hold the monoimplant by the monoimplant carrier.

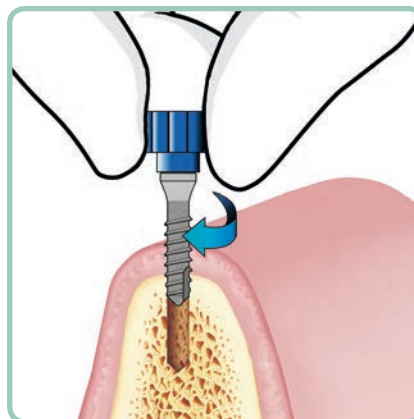

3.5 Still holding the monoimplant by the monoimplant carrier, insert it into the implant site with clockwise movement, while exerting a light downward pressure. Leone monoimplants are self-tapping.

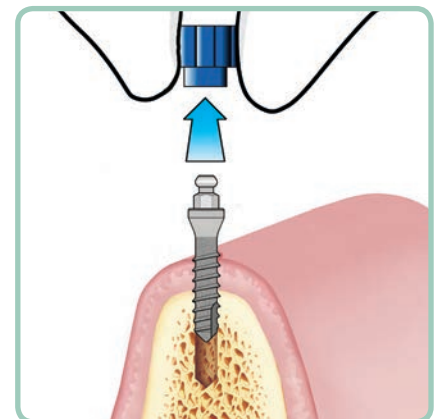

3.6 Remove the monoimplant carrier by pulling up.

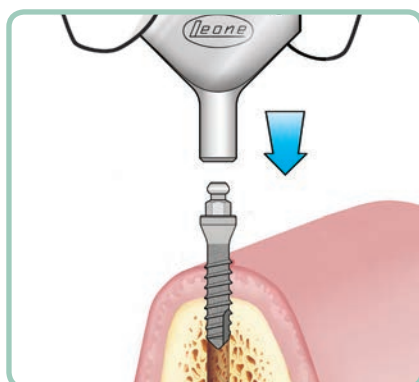

3.7 Position the fan-type wrench (Cat. 156-1015-00), included in the organizer. Its opening is engineered to fit the hexagonal head of the monoimplant with precision. This wrench presents a hole sideways for the insertion of a safety leash.

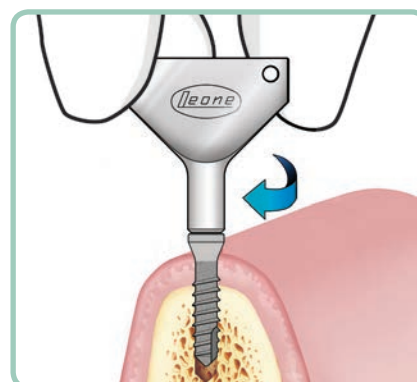

3.8a Screw the monoimplant with clockwise action in, until insertion is complete.

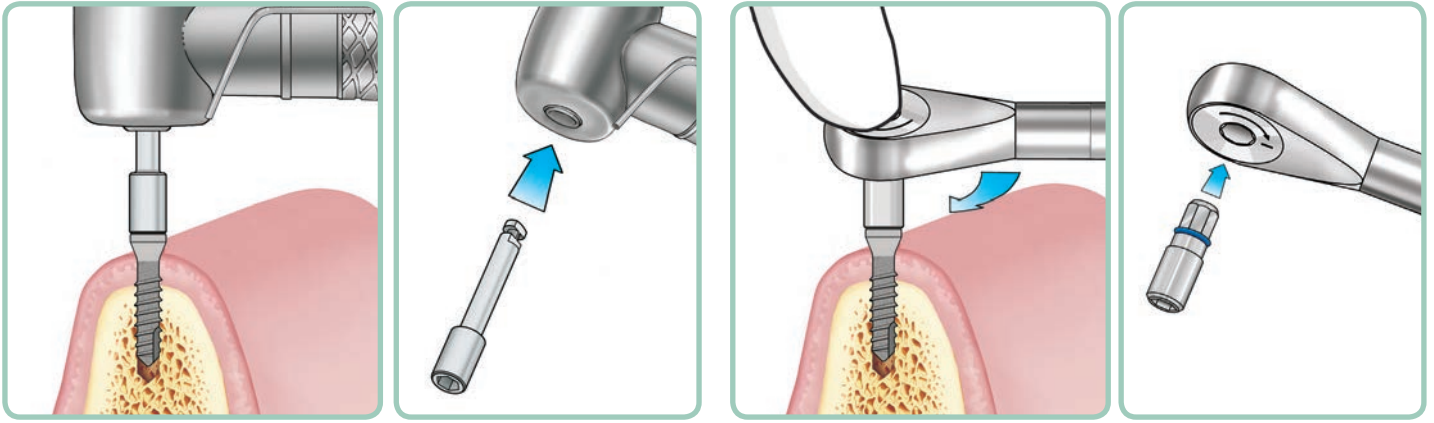

3.8b Alternatively, the monoimplant may be inserted with a contra-angle, using the special adapter (Cat. 156-1017-00) included in the organizer as well. Set a micromotor's maximum speed to 20 rpm and a maximum torque value to 50 Ncm.

3.9 In case of particularly hard bone, the monoimplant can be inserted with the ratchet Cat. 156-1014-00, using the appropriate adapter Cat. 156-1016-00.

N.B.: Should a ratchet be used to complete the insertion, it is recommended that the clinician should lightly press the head of the instrument with a finger during action, to keep the head perpendicular with the implant.

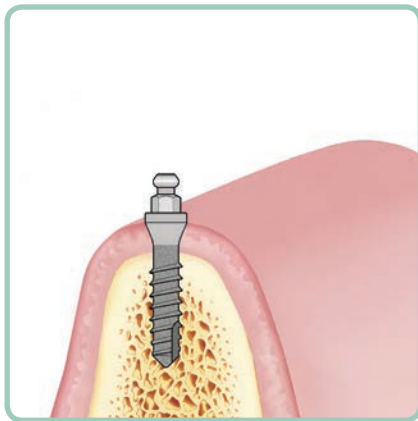

3.10 Once the monoimplant is in place, the base of the tapered section of the head should sit level with the crestal bone, while the head should stick out of the gum.

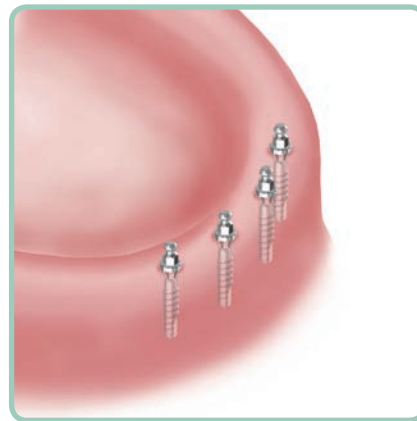

3.11 Repeat steps 3.1 – 3.10 for the remaining three monoimplants. Should a flapping technique be used, suture soft tissues around the monoimplants and load implants after healing has taken place. In the meantime relieve the existing prosthesis in correspondence of the spherical heads of the monoimplants and fill the holes with soft acrylic.

4) PREPARATION OF THE REMOVABLE PROSTHESIS



During relining of the pre-existing prosthesis or manufacture of a new one, provide a wide tissue support for the prosthesis. Particular care has to be paid also to the correct tissue support of the prosthesis during the subsequent periodical checks, carrying out prosthesis relining, if necessary.

CAUTION: *it is recommended to deliver the final prosthesis in the initial phase without housings to the patient to allow for adequate tissue adaptation and to correct possible impingements. The clinician will determine the length of the adaptation period.*

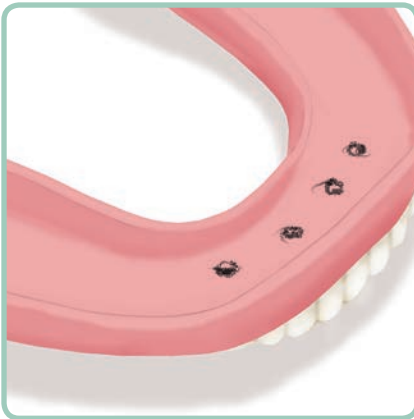

4.1 Once the prosthesis is ready apply some soft wax on the inside surface of the prosthesis or dab the spherical heads of the monoimplants with a marker pen to reveal their location in the prosthesis.

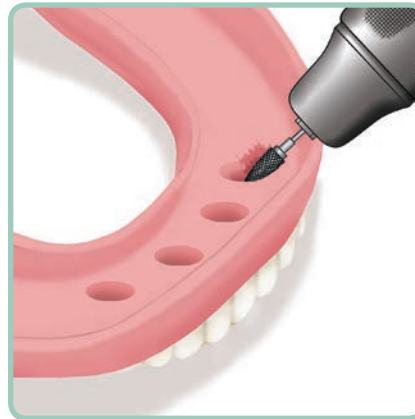

4.2 Use the marks thus obtained in the prosthesis as reference; create the cavities with adequate diameter to receive the micro housings.

CAUTION: *if you are not sure whether the monoimplants have achieved adequate primary stability, we recommend relining the prosthesis with soft acrylic and waiting for a minimum of 3 months for osseointegration before incorporating the housings into the prosthesis.*

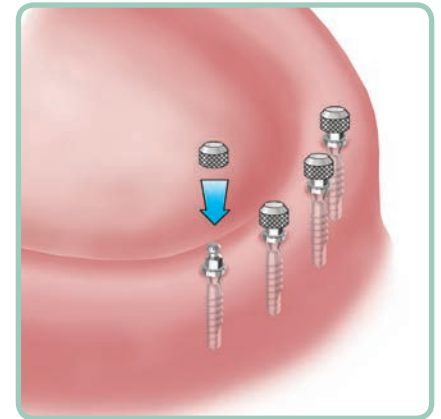

4.3 Place the micro housings on the spherical heads of the implants then press down until home. Slight lack of parallelism can be overcome by using the housings Cat. 123-0002-00.

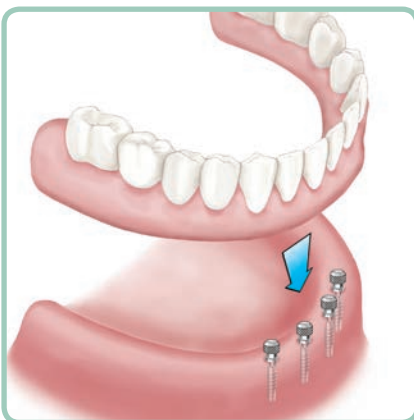

4.4 Insert the prosthesis in the patient's mouth for the final check. Occlusion should at this point be free from friction and unwanted contacts. The prosthesis may be relieved in correspondence of the micro housings' cavities in order to obtain a perfect tissue borne prosthesis without any friction on the housings.

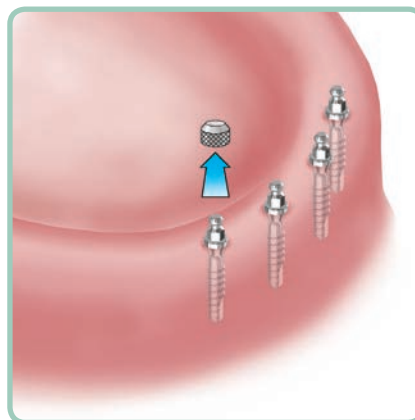

4.5 Remove the prosthesis and micro housings from the implants.

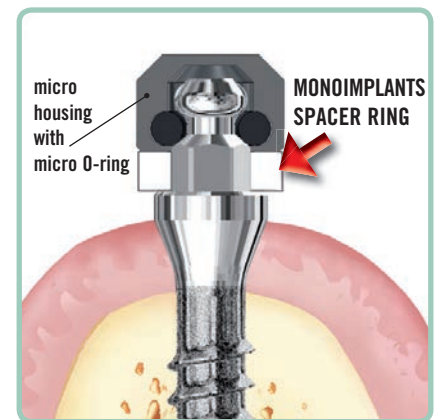

4.6 Place over each monoimplant the specific white spacer ring. Please remember that this white spacer ring is used to incorporate the micro housing with O-ring Cat. 123-0003-00 or the housing with O-ring Cat. 123-0002-00 into the prosthesis. The spacer rings allow a precise incorporation of the housings into the prosthesis without displacements, promote a correct resilient retention of the prosthesis and protect the undercuts of the spherical heads from acrylic.

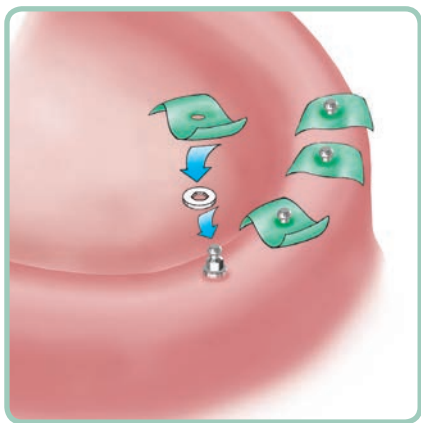

4.7 Place squared pieces of rubber dam over each monoimplant to avoid a direct contact between the soft tissue and the acrylic.

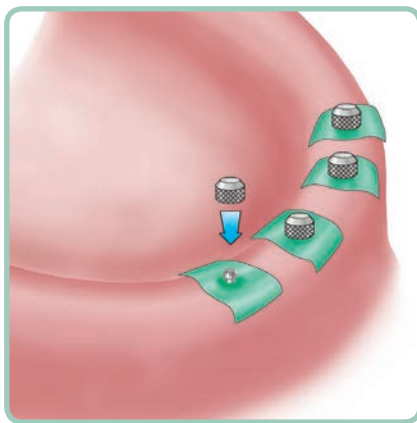

4.8 Place the micro housings onto the monoimplants. Please remember that all housings should be incorporated at the same time into the prosthesis and not at different moments.

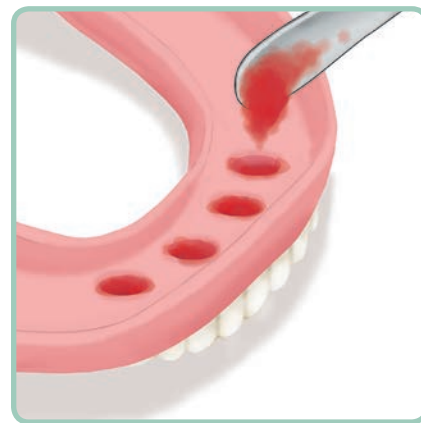

4.9 Fill the 4 cavities in the prosthesis with self-curing acrylic and as may be the case put the acrylic also on the micro housings.

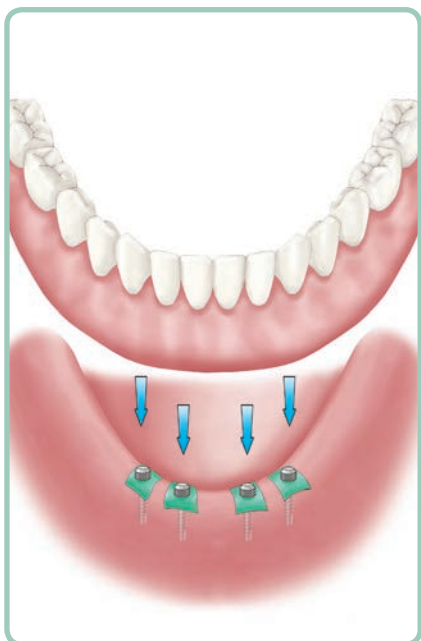

4.10 Fit the prosthesis in the mouth of the patient looking for adequate occlusal contact. The patient at this stage should not try to close his/her mouth too tightly.

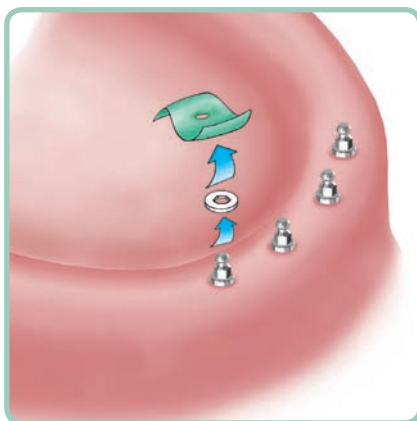

4.11 After the polymerization of the acrylic has been completed, the prosthesis is removed from the patient's mouth. The micro housings, due to their highly retentive surface, are kept in the prosthesis. Remove the rubber dams and the spacer rings from the monoimplants' heads.



4.12 Remove any acrylic excess until the edges of the micro housings are completely exposed. Correct any discrepancies that may cause impingement problems. Finish and polish the prosthesis.

For replacing an O-ring and prosthesis maintenance, please refer to the indications on page 97.

QUALITY FOR THE SATISFACTION OF THE CUSTOMER

The secret to guarantee a good quality of the product is that of meeting or even exceeding the customer's expectations: the awareness of such expectations is the first step, perhaps the most important step, to furnish a quality product as a standard. The manufacture of superior quality products in respect of the expectations and the demands of the customer and in attendance of the legally binding directives has always been the philosophy of Leone. It implies that any company department, at any level, is called to share such goals supporting the Management in the fulfilment of the necessary operational strategies. The Leone management quality system is conforming to UNI EN ISO 9001, additional requirements of ISO 13485, according to Annex II of the Directive 93/42EEC, USA FDA 21 CFR Part 820 rules and Japanese Ministerial Ordinance MHLW no. 169.

CUSTOMER SERVICE



COMPETENCE AND RELIABILITY

The Leone dealers worldwide are under constant professional improvement thanks to the technical assistance received by engineers and technical experts at Leone to get specific information on the products and solve any eventual problems from the customers.

In our website www.leone.it, under the section "Distributors", you will find the information to contact the Leone dealer in your country.

PROMPTNESS

By providing a careful management and a "state-of-the-art" logistic system, we are able to deliver standard orders with the best precision and ship the goods very quickly.

LEONE NEWSLIST

Keep yourself updated with the latest news of our products: click on "Services" in our website www.leone.it and fill in the registration form.



TECHNICAL AND COMMERCIAL ASSISTANCE

Contact your dealer in your country as a reference. You will find the comprehensive list under the section "distributors" in our website www.leone.it

A

Abutments:	
anatomical - LEONE 360°	13..15
angled	14-19-22-25
angled double - 10°	18
ball head for overdenture	21..23
cylinder	12-17-18
for Large platform	17
for Slim platform	18
for Standard platform	12..14-21..23
MultiTech	19
pre-inclined	12-17
standard for screw-retained prosthesis	24..26
temporary	12
Ti-Base	20
try-in - LEONE 360° anatomical type	15
try-in - Standard, Large type	28
Abutment beater	38
Abutment seating tips	38
Accessories for abutments for screw-retained prosthesis	26
Accessories for ball head abutment for overdenture	23
Accessories for screw-retained prosthesis	24-26-27
Adapter for connecting screw	26
Adapter for handpiece	37
Adapter for handpiece for monoimplants	50
Adapter for ratchet for monoimplants	50
Analogs	29
Analogs for abutments for screw-retained prosthesis	27

B

Basin - titanium	39
Bone condenser tip	37
Bone graft tip	37
Burs and drills:	
countersink	32
FG diamond-cut	27
FG tungsten	27
for abutments	27
for hard bone	32
for short implant LEONE 6.5	32
lance	31
pilot	31
pilot with depth stop	33
round	31
twist	31
twist with depth stop	34

C

CAD-CAM	19-20
Connecting rings - elastomer	35
Connecting screws for screw-retained prosthesis	26
Coping for abutments for screw-retained prosthesis	27
Cover caps	7

D

Demonstration anatomical models	45
Demonstration hemi-mandible	46
Demonstration jumbo dental implant	46
Demonstration surgical kit	46
Dental implants	6..10
Depth gauge	36-49
Depth indicators	30
Driver for implant	36

E

Extension	33-36
-----------	-------

H

Hand screwdriver for implants	36
Hand screwdriver for monoimplants	50
Handle for abutments	29
Healing caps:	
Large	16
Slim	18
Standard	11
Hex head extractor for healing caps	38
Hexagon for LEONE 360° abutment	14
Housing with O-ring	22-48

I

Identity card for LEONE dental implant	46
Implant system - LEONE	6..10
Instrument for cover caps	38

M

Max Stability LEONE dental implant	9
Measuring pin for gingival height	36-49
Micro housing with insert	23
Micro housing with O-ring	22-48
Micro insert	23
Micro O-ring	23-48
Monoimplants for O-ring overdenture	47..50
Mucosa punches for implants	30
Mucosa punch for monoimplants	49
MultiTech - abutment	19

O

Offset adapter for threaded handle	37
Organizer:	
for implants Ø 3,3-4,1-4,8	42-43
for Max Stability LEONE implant	43
for monoimplants for O-ring overdenture	49
for short implant LEONE 6.5	43
with burs FG for abutments	27
with drills with depth stop	44
with drills with depth stop and taps	44
with instruments	44
with taps	44
O-ring, elastomer	23-48
Osteotome instruments	39
Overdenture insert seating tool	23
Overdenture micro housing	21..23

P

Paralleling pin	36
Patient informative brochure	46
Platform switching	10
Platforms:	
Large	10-16-17
Slim	10-18
Standard	10..14
Positioner for depth indicators	30
Prosthetic instruments and accessories	27-29

R

Ratchet	35
Refills:	
accessories for abutments for screw-retained prosthesis	26

for ball head abutment for overdenture	23
hexagon for LEONE 360° abutment	14
plastic scan body	20
support ring for driver	36
try-in abutments	15-28
Removal tool for abutments	36

S

Scan body	20
Scan post	20
Scan post positioner	20
Screwdriver for connecting screw - short	26
Screws:	
high head connecting screw	26
pick-up screw	26
standard connecting screw	26
Seating tips for abutments	38
Self-locking caps, low	11
Short implant LEONE 6.5	8
Sinus lift tip	37
Support ring for driver	36
Surgical instruments	30..39
Surgical kit	40-41
Surgical mallet	39

T

Taps	35
Template for implants	39
Template for monoimplants	50
Tip change wrench	37
Tip for angled abutments	38
Threaded handle	37
Transfer:	
for abutments for screw-retained prosthesis	26
Large	16
pick-up for abutments for screw-retained prosthesis	26
Slim	18
Standard	11
Try-in abutments, LEONE 360° anatomical type	15
Try-in abutments, Standard, Large type	28

W

Waxing screw - long	27
---------------------	----



EDUCATION, TRAINING, UPGRADING

Since 1982, the ISO, Istituto Studi Odontoiatrici, has been operating with the purpose to promote new therapeutic techniques and to divulge dentistry and implant dentistry to ever higher standards. The Leone's teaching facility is spread out over two floors with a total surface area of 1000 square meters. During the last 30 years of activity, the ISO training center has taken lectures to more than 43.000 attendees. ISO offers a comprehensive program of courses for dental surgeons, dentists, specialists in dentistry and orthodontics.

Hands-on courses for dental technicians and commercial training in orthodontics and implant dentistry for Italian and foreign traders are also available.

STATE-OF-THE ART FACILITY

With the exception of the reception area, the first floor of the building is dedicated to the lecture rooms: a **dental operatory** equipped with **2 dental units** for live demonstrations of both orthodontic and implantological interventions. A lecture hall seating up to **40 participants**, allows the doctors to visually participate in the interventions.

Endoral and extraoral cameras film the procedures which are wired in to big screens in the various lecture halls at a real time.

A 18-bench **dental laboratory** fully equipped.

A **multi-purpose lecture hall** for 80 trainees has been recently endowed with the **interactive learning** Active Classroom environment, providing an interactive multi-media board and learners' active response tools which enable the attendees to become active participants in the course.

On the second floor is our **"Marco Pozzi" lecture hall** seating up to **250 participants**.

The didactic tools available at the ISO and the high qualified lecturers make each event a profitable and memorable one for every participant.

For detailed information on courses and events

visit our website: www.leone.it/corsi

or contact the ISO reception office:













Phone +39.055.304458 - Fax +39.055.304455 - iso@leone.it

Follow us on Facebook



PRODUCT LABEL SYMBOLS

The label on the package of any medical device set on the market will show the symbols in compliance with the harmonized standards. The symbols marked with a single (*) are based on the ISO 21531, ISO 15223-1, EN 980 European Standard and on the 93/42EEC Directive. The symbols marked with double (**) have instead been performed by us.

manufacturer's trade name and address	manufacturer's catalogue code number and product description in different languages	bar code
CE mark (made in compliance with 93/42EEC Directive on class IIA or IIB medical devices)	 (*) expiry date, if the product is perishable (year/month)	 (*) 2030-12 storage temperature
lot number (indicated by LOT mark)	 (*) for professional use only	 (**) single use only
keep dry	 (*) this product contains Nickel-Chromium: possible allergic reactions	 (**) keep away from sunlight
CE mark (made in compliance with 93/42EEC Directive on class I medical devices)	 (*) refer to instructions for use	 (*) gamma-ray sterilized
titanium	 (*) surgical steel	 (*) this product contains Chromium: possible allergic reactions
autoclavable at temperature indicated	 (*) polyethylene	 (*) non-sterile
polyetheretherketone	 (*)	

INFORMATION FOR DISTRIBUTORS OF DENTAL IMPLANTS: INTENDED USE, RESPONSIBILITY, SURVEILLANCE

The 93/42EEC Directive on medical devices is the official reference that dictates the regulations for marketing medical devices. The directive provides indications for all the phases of existence for the device (from the project phase through the traceability system, and surveillance), and it identifies all the characters who have to comply with the directive itself, which includes not only the manufactures, but also the distributors, the buyers, and even the users. As for the responsibilities of the single competence, Leone S.p.A. recommends to its direct clients, dental depots and exclusive dealers to follow and maintain the indications, warnings, and information for the univocal identification of the medical devices, as provided by the manufacturer on the labels, during all the marketing phases. With specific regard to Class IIB implantable products, all dental depots and exclusive dealers of Leone S.p.A. are required to keep records of the distribution of medical devices as of traceability available for verification, in case of need to trace back a product or its user in a univocal way.

HOW TO REACH LEONE



BY AIRPLANE

from the Peretola airport "A. Vespucci", five minutes by taxi.

BY CAR

- from the highway "Autostrada del Sole", exit Firenze Nord, in the direction of Florence,
- along the highway A11, exit Sesto Fiorentino, on your right side the Novotel and Ibis Hotel can be seen.
- At the second traffic circle, turn on the first exit on the right (McDonald's).

Coordinate GPS: +43° 48' 4.85" N, +11° 11' 0.23" E

BY TRAIN

from the central station "Santa Maria Novella", take bus no. 30, get off in Via Pratese near the car dealer Volkswagen.

Call **+39.055.3044620** or send an e-mail message to **info@leone.it** for further information on Leone products or a visit to our factory.

You can also visit our web-site: **www.leone.it**

Leone s.p.a. does not assume risk and liability resulting from the use of the products listed in this catalogue. Since they are intended for implanto-prosthetic use only, their use has to be restricted to skilled and licensed professionals, who will be held the sole responsible for the construction or the application of any implanto-prosthetic appliance partially or fully manufactured with the above mentioned products. All Leone products are designed and manufactured for single use and once removed from the patient's mouth, must be disposed of properly. Leone s.p.a. disclaims any liability for the spread of disease or personal injury caused by reuse.

All rights reserved. No part of this catalogue may be reproduced in any form. Due to continuing product improvements, Leone s.p.a. reserves the right to discontinue products or change the design and materials of products without notice.

