



We know conveyor.

EZLOGIC[®] COMPONENT MANUAL



POWERED BY
CONVEYOR SOLUTIONS

Use code **HYPMANUAL** for free shipping
your first order at HytrolParts.com

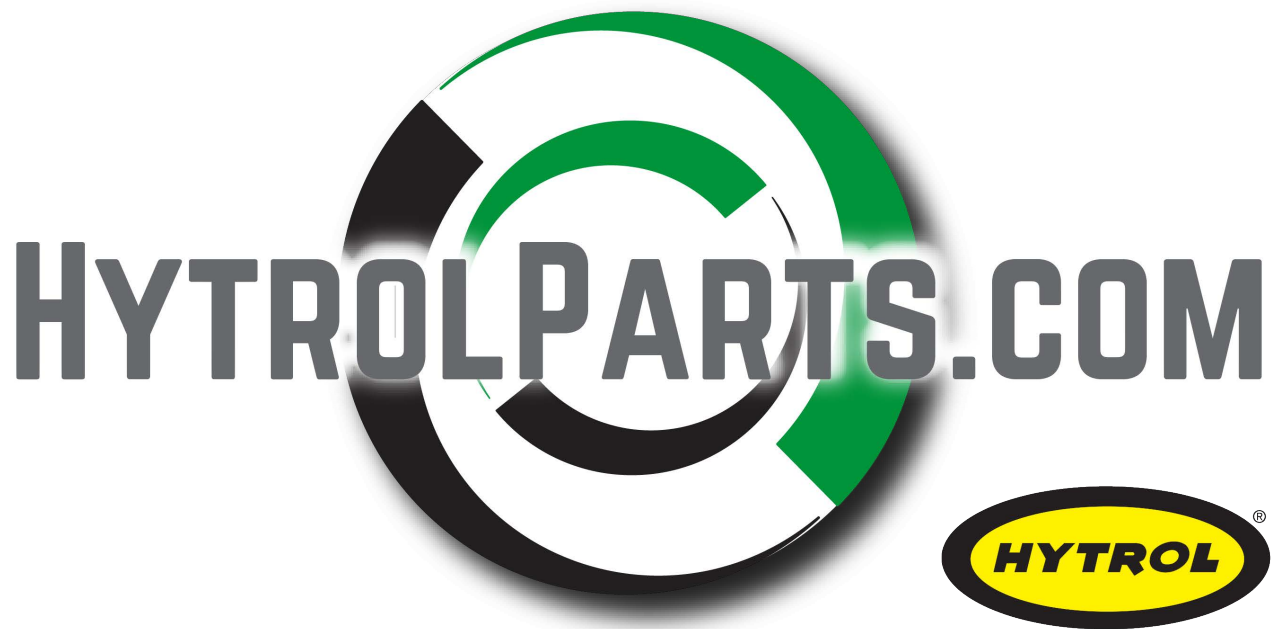

POWERED BY
CONVEYOR SOLUTIONS

"Building Relationships One Conveyor Part at a Time"

support@hytrolparts.com | www.HytrolParts.com

CONTENTS

Overview	4		
• Introduction	4	Power Splitter	13
What is EZLogic®?	4	• Configuration/Diagnostic	14
• Features of the EZLogic® Accumulation System	4	EZLogic® Pushbutton Programmer	13
Zero-pressure accumulation of product	4	PC Adapter with Genesis™ Configuration Software	14
Operational modes	4	Removal & Installation	15
Sleep feature	4	• Zone Controller/Transducer	15
Local and remote inputs and outputs	4	Zone Controller Removal	15
Plug-in connections and “snap-together” mounting	4	Zone Controller Installation	16
Jam protection	5	• Cordset Removal/Installation	16
Special functions	5	Cordset Removal	16
Easy configuration options	5	Cordset Installation	17
• Description of Operational Modes	5	Base Removal/Installation	17
Singulation Mode	5	• Base Removal	17
Fixed Zone Length	5	Base Installation	17
Dynamic Zone Allocation	5	• IOP Unit and Related Cables	17
Slug Mode	5	Installing the IOP Unit	17
Components	7	Installing the IOP Tee Cable	19
• Main Components	7	Installing Isolation Cables	19
Zone Controller/Transducer Assembly	7	• Connecting to External Controls	20
Controller Base	7	Connecting Inputs Using the Auxiliary Input Cable	20
Cordset	8	Connecting Outputs Using the Auxiliary I/O Module	20
EZLogic® Zone Controller	8	Configurable features	22
Transducer (Sensor)	8	Sleep Feature	22
Retaining Clips	9	Singulate/Slug	22
IOP Unit	10	Zone Output Mode	23
• Auxiliary Components	10	Jam Protection	23
Auxiliary Components	10	Diffuse Sensitivity Setting	24
Auxiliary Input Cable	10	Zone Operational Mode	25
Auxiliary I/O Module	10	Fixed Zone Length	25
Zone Actuation Module (ZAM)	11	Dynamic Zone Allocation (default)	25
Auxiliary Photo-eyes	11	Sensor Configuration	25
• Cable Components	12	Zone Stop Mode	26
IOP Tee Cable	12	Accumulation Delay	26
Power and Logic Extension Cables	12	Loading Zone	27
Power Isolation Cable	12	Unloading Zone	27
IOP Isolation Cable	13	Auxiliary Input Mode	27
Remote Transducer/Auxiliary Extension Cables	13	Auxiliary Output Mode	28



• Special Logic Functions	29	Preferences	49
Cascade Release (for Slug Mode)	29	Load Model Defaults	49
Brake Pulse (for gravity conveyors)	30	Load Configuration	50
PE (Photo-Eye) On Delay	30	Save Configuration, Save Configuration As...	50
PE (Photo-Eye) Off Delay	30	• Device Menu	50
Zone Kill	30	About Device	50
Controller Setup Functions	30	Clone	50
Clone	30	Enable (Disable) Clone Protection	50
Reset Functions	31	Auto Configure	51
Auto Configure	32	Diagnostic Information	51
<u>Configuring Zone Controller with Push</u>		Reset Diagnostics	51
<u>Button Programmer</u>	33	Status Monitor	52
• Displaying Current Settings	33	• Enhanced Menu	53
Left button pressed	33	IOP Configuration	53
Right button pressed	33	Initialize Addressing	53
• Selecting and Changing Settings	35	Map Device Chain	53
Basic Configuration Procedure	36	Connect to...	53
Configurable Functions and Settings	37	• Comm Menu	54
EX # 1: Changing the Sleep Timer Setting	38	More About Remote Connection and Addressing	54
EX # 2: Setting All Zones to "Slug Mode Only"	39	<u>Product Specifications</u>	55
EX # 3: Resetting All Zones to "ABEZ Defaults"	40	EZLogic® Zone Controllers/Accessories	55
<u>Configuring a Zone Controller with Genesis™</u>		Zone Controllers/Transducers	55
<u>Configuration Software</u>	41	• Cordsets	56
Installing Genesis™ on a PC	41	Push-On	56
Connecting the PC to a Zone Controller	41	Screw-On	57
Starting Genesis™	41	• Cables, Power and Logic	57
Main Screen—Display Mode	43	Push-On	57
Zone Controller Description	43	Screw-On	57
Current Controller Configuration	44	• Cables, Other	57
Toolbar	44	Auxiliary Components	58
<i>Local/Remote Address Bar</i>	44	Configurations Components	58
Main Screen—Edit Mode	45	IOP Unit and Components	59
Editing a Configuration Setting	46		
Special Logic Functions	47		
Standard Zone Controllers	47		
Enhanced Zone Controllers	48		
The Menu Bar	49		
File Menu	49		



OVERVIEW

• Introduction

This manual describes the installation, operation, configuration, and specifications of the Hytrol EZLogic® accumulation system. Please read this material carefully to familiarize yourself with the system and its operation.

What is EZLogic®?

EZLogic®, or Electronic Zero-pressure Logic, is a method of zero-pressure control that combines the sensing accuracy of photo-electrics with discrete electronic logic control without the use of a PLC or pneumatic logic components. This system provides all the “intelligence” needed to accurately control the various functions of zero-pressure accumulation on a variety of conveyor models. Reduced noise, higher reliability, higher throughputs, and ease of maintenance are just some of the advantages of the EZLogic® system.



The heart of the EZLogic® Accumulation System is the EZLogic® zone controller. Each controller is equipped with a photoelectric input device to detect product presence, a microprocessor to evaluate various input signals, and control connections to provide communication of data between zones and to and from outside sources. Two types of product sensing are available: A retro-reflective type which is used in conjunction with a reflector to detect packages by looking across the width of the conveyor, and a diffuse type which is used to detect packages when a reflector cannot be used.

Figure 1—EZLogic® Zone Controller

• Features of the EZLogic® Accumulation System

The following is a brief description some of the features of the EZLogic® accumulation system. These features are described in more detail later in this manual.

Zero-pressure accumulation of product

This is the primary function of the EZLogic® system. Cartons or pallets may be stopped on the conveyor without the build-up of line pressure.

Operational modes

The EZLogic® system provides two primary modes of operation: singulation mode and slug mode. Singulation mode may be further configured to operate in fixed zone length mode or dynamic zone allocation mode.

Sleep feature

Conveyor zones that have not seen any carton activity for a selected period of time may be set to “go to sleep,” or stop driving, until activity is detected, reducing system noise and component wear and reducing energy consumption.

Local and remote inputs and outputs

Inputs to control carton release, operational modes, etc, may be wired to any EZLogic® zone controller in the system. Additionally, the EZLogic® system provides various output options, such as “zone full” and “zone blocked and stopped,” that may be accessed locally. Control inputs and outputs may also be connected in one central location to interface with controllers remotely using the IOP control wiring system.



Plug-in connections and “snap-together” mounting

EZLogic® zone controllers, cordsets, and accessory components are all provided with sealed plug-in connectors for robustness and true “plug and play” convenience. In addition, controllers and auxiliary components snap to the conveyor without tools, allowing for quick installation and component replacement.

Jam protection

When the conveyor is set to run in “slug mode,” if a carton becomes jammed on the conveyor, EZLogic® will detect the jam and accumulate cartons upstream from the jam. This prevents product pile-up until the jam is cleared.

Special functions

The EZLogic® system also offers many special functions. Some of these enhance product flow, such as the cascaded release function, while others are designed to reduce the need for external controls, such as the indexing zone stop and loading and unloading functions.

Easy configuration options

The EZLogic® system comes pre-configured with the most common settings for your particular conveyor model. EZLogic® zone controllers may be configured to meet the needs of your system using the EZLogic® pushbutton programmer, or by using a computer and Hytrol’s “Genesis™ Configuration Manager” software. Genesis™ Configuration Manager also allows the user to save and retrieve configurations, retrieve diagnostic information, and access more advanced options.

Once a controller is configured, the configuration from that controller may be copied to other controllers in the system by using the clone feature of the controller.

• Description of Operational Modes

The EZLogic® accumulation system provides two primary modes of operation for transporting and accumulating product: Singulation mode and slug mode. These modes are described below.

Singulation Mode

Singulation mode provides individual carton control during transport and accumulation. Each carton is assigned a “zone” as it accumulates on the conveyor. Upon release, the cartons are held in their respective zones until the zone immediately downstream is clear. The cartons are thus separated, or “singulated” as they are released and/or transported.

There are two ways that EZLogic® can assign zones to cartons:

Fixed Zone Length

When the zone operating mode is set to “fixed zone length” each carton is assigned one mechanical zone (the zone length determined by the mechanical “build” of the conveyor) as it is transported and accumulated. The zone length must be longer than the longest carton to be conveyed. When cartons are transported or released, a gap equal to the length of one mechanical zone is created between the cartons.

Dynamic Zone Allocation

When the zone operating mode is set to “dynamic zone length” EZLogic® uses a process known as “dynamic zone allocation” to adjust the zone length to fit the carton being conveyed.

The mechanical zone length (determined by the mechanical “build” of the conveyor) becomes the “base” zone length when using dynamic zone allocation. Each carton is assigned enough “base” zones to accommodate its length. For example, if the conveyor is built up using 12-inch “base” zones, a 9-inch box will be assigned one “base” zone, or 12 inches, while a 21” box will be assigned two “base” zones, or 24 inches. The cartons are thus allocated the proper number of “base” zones as required by the cartons.



OVERVIEW

As cartons are transported or released, a gap equal to the length of one “base” zone is created between the cartons, regardless of the carton length.

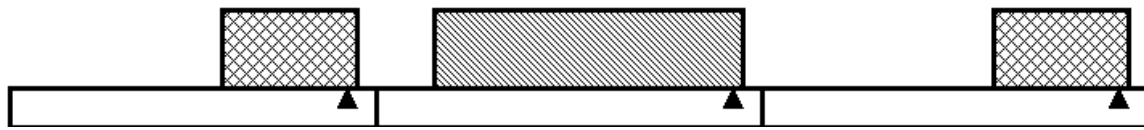

Figure 2 — Fixed Zone Length

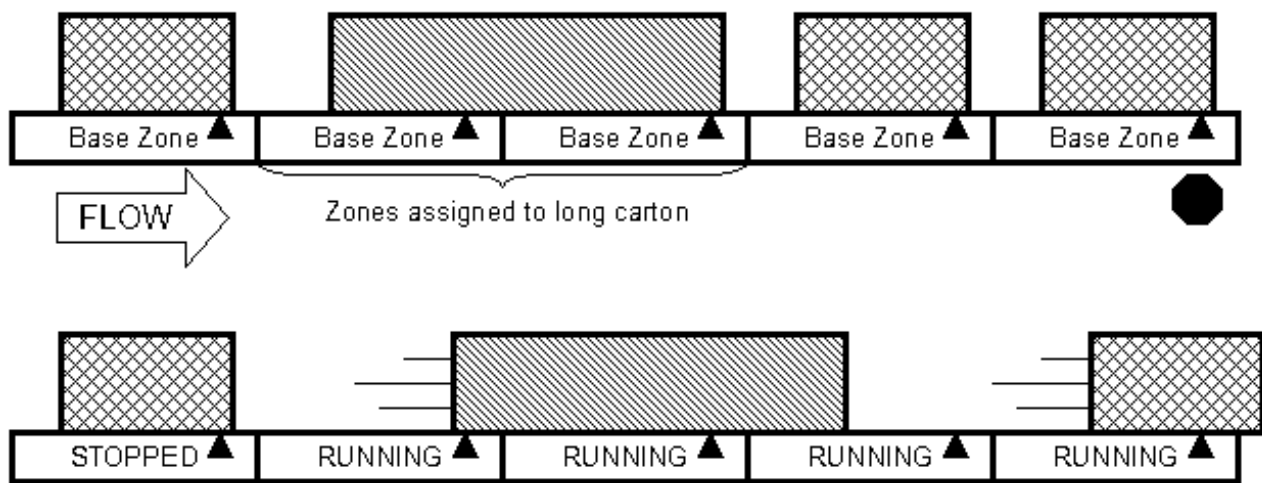

Figure 3 — Dynamic Zone Allocation

Slug Mode

Slug mode provides dense accumulation and high throughput when individual carton control is not required. Cartons are not separated when traveling down the conveyor or when they are released from the conveyor. Zero pressure is still provided during the accumulation cycle, but only as the cartons arrive at the proper “stopping point.”

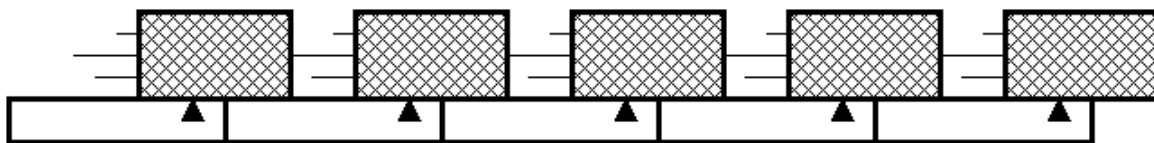

Figure 4 — Slug Mode

COMPONENTS

The EZLogic® accumulation system is made up of several physical components that work together to provide you with a simple, yet powerful control system for your zero-pressure conveyor. These components may be divided into the following categories:

- Main components
- Auxiliary components
- Cable components
- Configuration/diagnostic components

• Main Components

Main Components are those parts of the EZLogic® system that are essential for conveyor operation and provide most of the functionality of the system. These parts include the zone controller/transducer assembly and the IOP (Input/Output/Power) unit.

Zone Controller/Transducer Assembly

The zone controller/transducer assembly is the heart of the EZLogic® accumulation system. There is one assembly located in every mechanical zone of any EZLogic®-equipped conveyor. It consists of six components:

- Controller base
- Cordset
- EZLogic® zone controller
- Transducer (sensor)
- Retaining Clips (2)

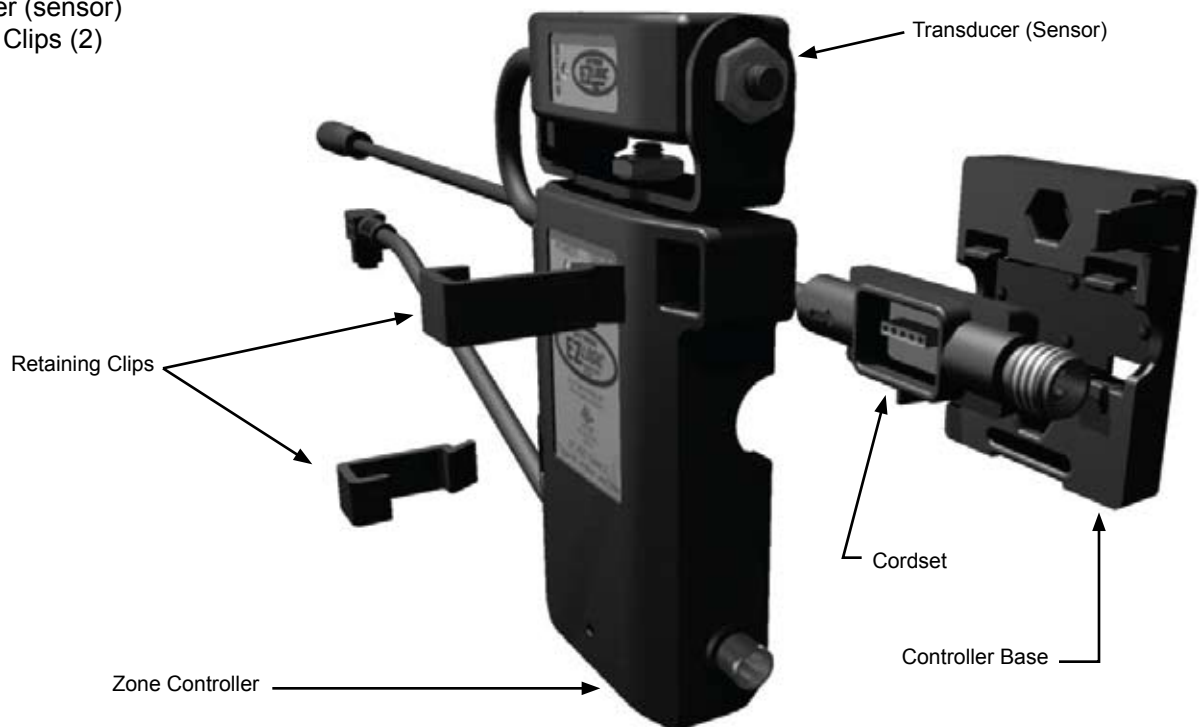

Figure 5—Zone Controller/Transducer Assembly



Controller Base

The controller base is the foundation for the other components of the zone controller/transducer assembly. It mounts to the conveyor using either a mounting tab and one fastener or two fasteners. The base provides snap-fit mounting for the cordset and the zone controller. This allows for easy, fast, and flexible assembly and/or replacement of components.

Cordset

Cordsets provide the power and communications path for EZLogic®. There is one cordset per mechanical zone of the conveyor, with the cord length matched to the zone length. Each cordset snaps into a controller base and provides the plug-in point for a zone controller. The cordsets connect together in a “daisy-chain” fashion using push-on connections to create the “power and logic distribution” chain.

The cordsets are marked with an arrow indicating the default direction of product flow on the conveyor. They may be installed into the controller bases in either a “left hand” or “right hand” orientation. This orientation of the cordsets determines the default direction of product flow for the EZLogic® system.

EZLogic® Zone Controller

The main element of the EZLogic® accumulation system is the EZLogic® zone controller. The zone controller uses microprocessor technology to monitor various inputs from adjacent zone controllers and from outside sources, process that information based on certain parameters, provide the proper output to control the drive status of the zone, and to communicate status information to the other zone controllers.

EZLogic® zone controllers come in two basic physical variations:

Unitized zone controllers have the transducer (sensor) “hard-wired,” or permanently attached. The controller provides the mounting point for the transducer, eliminating the need for further mounting hardware.

Remote zone controllers do not include the transducer. Instead, a connector is provided to allow the attachment of remote-type transducers. These transducers may be mounted separately from the controller, providing flexibility in various conveyor applications.

In addition to the physical variations above, EZLogic® zone controllers are also available in two functional variations:

Standard zone controllers provide an extensive function set to meet the needs of most conveyor applications from the most basic to advanced systems. They are identified by the EZLogic® logo with yellow background.



Figure 6—Unitized Zone Controller



Figure 7—Remote Zone Controller

Enhanced zone controllers expand on the functionality available in standard zone controllers by providing advanced communication and functional capabilities. They are identified by the EZLogic® logo with white background.

Transducer (Sensor)

The transducer is the product-sensing portion of the zone controller/transducer assembly. Commonly called the sensor, current transducers available for the EZLogic® GEN3 system are photoelectric devices. Future transducers may incorporate other technologies.

There are three sensing types currently available:

Polarized reflex, or “retro-reflective” type transducers are used in conjunction with a reflector to detect product. Cartons passing between the transducer and the reflector interrupt a beam of light. This interruption indicates to the EZLogic® controller that a carton is present.

Adjustable diffuse transducers detect cartons by bouncing an infrared light beam off of the carton and back to the transducer. These transducers may be used when a reflector interferes with some other operation, such as loading or unloading. The sensitivity of adjustable diffuse transducers may be adjusted to best detect cartons without detecting objects away from the conveyor.

Narrow-beam diffuse transducers are specially designed to be able to “look” through a narrow space, such as between rollers spaced closely together. These transducers are designed to detect cartons near them, and are not adjustable.

There are two mounting styles available for transducers:

Unitized transducers are “hard-wired,” or permanently attached to a zone controller. The zone controller provides the mounting point for the transducer.

Remote transducers are designed to mount separately from the zone controller. They plug to a non-unitized zone controller. By using extension cables, a remote transducer may be mounted several inches away from the zone controller if necessary.

A special type of remote transducer incorporates a tee connection to allow for **dual transducer** operation. These transducers may be used to reliably sense oddly shaped or sized objects, or as “problem solvers” in other applications.

All transducers are mounted in brackets that provide alignment adjustment in both vertical and horizontal directions, making precise sensor alignment and special angled mountings possible.

All transducers are mounted in brackets that provide alignment adjustment in both vertical and horizontal directions, making precise sensor alignment and special angled mountings possible.



Figure 8—Polarized Reflex Transducer

COMPONENTS

Retaining Clips

The retaining clips are used to secure the zone controller to the base by locking the mounting tabs of the base. The clips simply snap in place over the tabs.

IOP Unit

The IOP (Input/Output/Power) unit is a key component of the EZLogic® system. The IOP unit performs two tasks:

- The unit provides power to the other EZLogic® components. It converts 100-130 VAC 1ph, or 210-250 VAC 1ph input power into the 27 VDC power required by EZLogic®.
- The unit is a hub and controller for the **IOP control wiring system**. This new concept in controls interfacing provides many advantages. Please refer to the “EZLogic® IOP Solutions” manual for more information.



Figure 9—IOP Unit

• Auxiliary Components

Auxiliary Components

Auxiliary components provide a way for EZLogic® to be interfaced with various external control devices, such as switches, relays, PLCs, etc, to receive control inputs and provide control outputs. The following is a list of available auxiliary components:

- Auxiliary Input Cable
- Auxiliary I/O Module
- Zone Actuation Module (ZAM)
- Auxiliary Photo-eyes

With the exception of the ZAM, all auxiliary components plug into any EZLogic® zone controller through the controller’s auxiliary port.

Auxiliary Input Cable

The auxiliary input cable is used to provide basic inputs to an EZLogic® zone controller. The cable has a connector on one end that plugs to the auxiliary port of a controller and a two-wire “pigtail” on the other. A connection between these two wires is interpreted by the zone controller as an “active” input signal. The wires may be connected directly or through any “dry contact” type switching device, such as a toggle switch or relay.



By default, an “active” input signal is interpreted by the zone controller as a “zone stop” signal and arms the “zone stop” function in that zone. The zone controller may be configured to interpret this input as one of the following signals:

- Zone Stop (default)
- Singulate/Slug
- Zone “Wake-Up”
- “Special Function” Inputs

Each of these inputs is described later in this manual.

Auxiliary I/O Module

The auxiliary I/O module is used to provide additional inputs and outputs to/from an EZLogic® zone controller. The module has two cables. One cable has a connector that plugs to the auxiliary port of zone controller. The other cable ends in a six-wire “pigtail.” These wires may be connected to external control devices to achieve the various I/O options.



Figure 10—Auxiliary I/O Module

The auxiliary I/O module can accept two types of input signals:

Standard (dry contact) type input is identical to the input accepted by the auxiliary input cable. Any “dry contact” type signal source, such as a toggle switch or relay, may be used to provide this input signal. No power source is required to operate this input.

Isolated (voltage) type input will accept a voltage signal as an input to the zone controller. Many PLCs send voltage signals to devices they control. By using the isolated (voltage) type input option the auxiliary I/O module provides, extra relays or expensive “relay type” PLC output cards can be avoided. This input operates on an 18-30 VDC signal.

Both types of input signals accepted by the auxiliary I/O module are interpreted by a zone controller as “zone stop” signals by default. The zone controller may be configured to interpret this input as any of the signals listed for the auxiliary input cable. In addition to the input options listed above, the auxiliary I/O module can provide a “solid state relay” output from a zone controller to an external device. Up to 30 VDC, 80mA current can be passed through this contact output to signal a PLC or other device.

By default the EZLogic® zone controller provides a basic “photo-eye” (transducer) status output through the auxiliary I/O module. The zone controller may be configured to provide the following types of outputs through the module:

- Photo-eye beam status
- “Zone blocked and stopped”
- “Special” outputs

Each of these is described later in this manual.

COMPONENTS

Zone Actuation Module (ZAM)

EZLogic® zone controllers provide a zone actuation output (the output that “tells” a zone to run or stop) that is suitable for operating a solenoid coil, such as the ones found on the EZLogic® solenoid air valves used on many Hytrol conveyors. Some conveyor models, particularly those using motorized rollers or other “individual zone” drives, require a different type of output signal from the controller.

For those applications where a different zone actuation output is required a zone actuation module (ZAM) is used. This module is connected to the standard zone actuation cable and can provide a sourcing, sinking, or contact-closure output as required to operate the zone mechanism used.



Figure 11—Zone Actuation Module (ZAM)

Auxiliary Photo-eyes

Auxiliary photo-eyes are specially configured photo-eyes that connect to the auxiliary port of an EZLogic® zone controller. These sensors are powered from the auxiliary port and provide an input to the zone controller when they detect an object. The zone controller may be configured to interpret this input as any of the input signals listed for the auxiliary input cable, such as the “zone wake-up” signal.

Auxiliary photo-eyes are used to “wake up” the infeed zone of pallet conveyors, and may be used in other applications. Retro-reflective and diffuse sensing versions are available.

• Cable Components

Cable components provide the means to supply power to the EZLogic® system, extend power and communication between components, and provide required isolation in multiple IOP systems. Cable components include:

- IOP Tee cable
- Power and logic extension cables
- Power isolation cable
- IOP isolation cable
- Remote transducer/auxiliary extension cables
- Power splitter

IOP Tee Cable

The IOP Tee cable is used between the IOP unit and the controller chain. It is typically located near the center of the controller chain and is designed to provide power and IOP communications from the IOP unit to zone controllers in the chain.

Power and Logic Extension Cables

These cables are used between zone controllers when the distance between them exceeds the length of available cordsets or when the cables must be routed around other equipment or accessories. Power and logic extension cables carry all power and communication signals between controllers.



Power Isolation Cable

This cable is used when multiple IOP units are necessary because of power requirements. Each IOP unit is capable of providing power to up to fifty EZLogic® zone controllers. When the number of zone controllers required exceeds this limit, multiple IOP units must be used.

The power isolation cable allows normal zone communication and IOP communication between sections of a zone controller chain powered by separate IOP units, while preventing the two sections from “sharing” power. This prevents unwanted electrical interference and conflicts between the sections, yet allows the sections to work together seamlessly.

IOP Isolation Cable

This cable is used when more than one IOP unit is being used in a zone controller chain as an IOP wiring hub. The cable prevents interference between the different IOP sections. Refer to the EZLogic® IOP Solutions manual for more information.

Remote Transducer/Auxiliary Extension Cables

These cables come in various length and are terminated with male and female 8mm, 4-pin “nano” style push-on connectors. They may be used when connecting to remote-type transducers. They also may be used with auxiliary components that connect to the auxiliary port of a zone controller. For example, an extension may be used with a pushbutton programmer to allow the programmer to be located in a convenient location.

Power Splitter

This special “Y” type cable allows two short, parallel conveyors to be powered from one IOP unit, as long as no more than fifty zone controllers total are being powered from one IOP unit. Note: The power splitter DOES NOT support IOP communications wiring.

• Configuration/Diagnostic Components

The EZLogic® accumulation system is designed to meet the needs of the simplest single-conveyor application, while providing features and functionality important to the most advanced multiple-conveyor systems. EZLogic® zone controllers supplied on Hytrol accumulation conveyors are shipped pre-configured with the most common settings used with that conveyor model. In many cases no changes are necessary for satisfactory operation. In others it is advantageous to make use of the rich feature set available in the EZLogic® zone controllers.

The following tools are available to configure EZLogic® zone controllers:

- EZLogic® Pushbutton Programmer
- PC adapter with Genesis™ Configuration software

EZLogic® Pushbutton Programmer

The EZLogic® pushbutton programmer plugs to the auxiliary port of any controller. Those familiar with previous versions of the EZLogic® system will recognize the familiar interface, which consists of three LEDs and two pushbuttons. This interface allows the user to configure the most frequently used features and parameters.





Figure 12—Pushbutton Programmer

PC Adapter with Genesis™ Configuration Software

The PC adapter cable with Hytrol's Genesis™ configuration software provides access to the full feature set of the EZLogic® zone controller. The cable plugs to the auxiliary port of a zone controller and provides a 9-pin RS232 serial interface to a Windows PC through a built-in serial port or, by the use of a third-party adapter, through an available USB port.

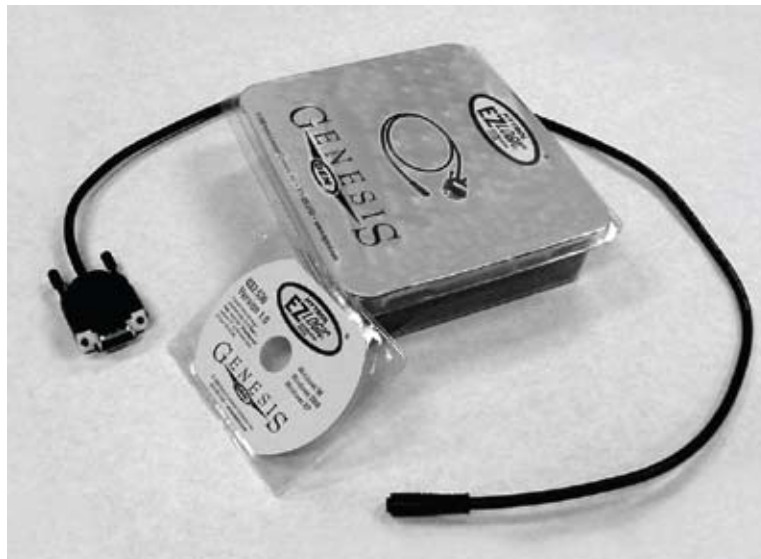

Figure 13 — PC Adapter and Genesis™ Software

REMOVAL & INSTALLATION

Hytrol zero-pressure accumulation conveyors equipped with the EZLogic® system are pre-assembled at the factory. The proper setup procedure varies from conveyor model to conveyor model. The information in this manual refers to typical installations and, while accurate, may not be complete. Please refer to the installation and maintenance manual for your specific conveyor model for information about the physical setup of your conveyor.

• Zone Controller/Transducer

Normally, the EZLogic® zone controller/transducer assemblies are installed at the factory and require no further installation, other than plugging together cordsets between sections. If zone controller installation or removal is necessary, such as for faulty component replacement, the following procedures should be used.

Zone Controller Removal/Installation

EZLogic® zone controllers may be removed and installed without disturbing the cordsets or other cabling, making replacement a simple task. The procedure for removal and installation of the EZLogic® zone controller is as follows:

Zone Controller Removal

Important! The following procedure may be performed with power applied to the EZLogic® system and with the conveyor operational. However, normal zone operation in the area of removal will be disabled until the zone controller is replaced. Depending on the conveyor model, this may result in carton movement or stalling. Use caution when performing this procedure “live”.

1. Disconnect the zone output cable from the air valve or other zone actuation device by pulling straight on the right-angle connector of the zone output cable. NOTE: do not twist this connection!
2. Remove the retaining clips by unlatching the hook of the clip with your finger. This releases the clip from the controller and base.
3. Using your finger, push the zone controller mounting tab located at the upper right corner of the zone controller toward the body of the zone controller, while gently pulling on the zone controller. NOTE: use of screwdrivers or other objects to pry on the mounting tab may result in damage to the zone controller.
4. Continue to pull gently on the zone controller until it releases from the base. If the zone controller does not release from the lower zone controller mounting tab, use your finger to push this tab toward the body of the zone controller until it releases.

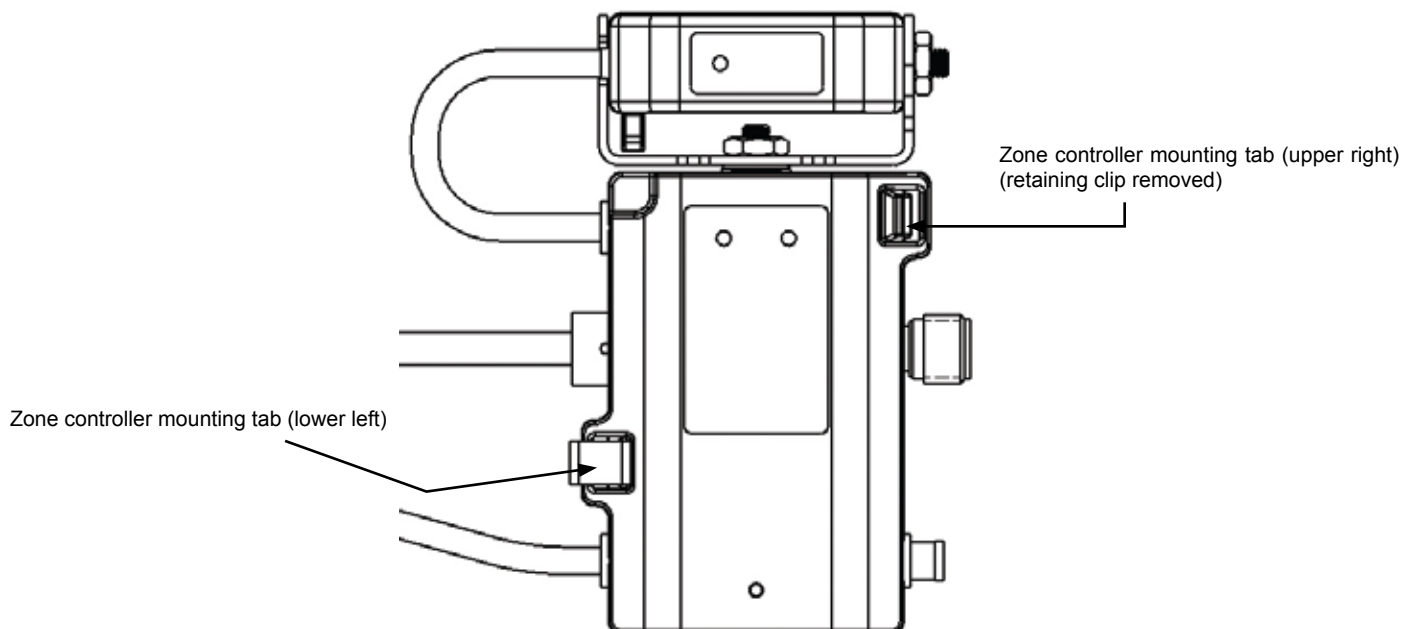

Figure 14 — Zone Controller Mounting Tabs



REMOVAL & INSTALLATION

Zone Controller Installation

1. Align the upper and lower zone controller mounting tabs of the zone controller base with the snap pockets of the zone controller.
2. Gently push the zone controller straight onto the base and cordset until both zone controller mounting tabs have engaged the zone controller.
3. Install the retaining clips by inserting the tab of the clip behind the base mounting tab and snapping the clip hook onto the zone controller.
4. Connect the zone output cable to the air valve or other zone actuation device by properly aligning the pins and sockets of the connectors and pushing the right-angle connector onto the valve/device until it snaps into place. NOTE: do not twist this connection!
5. If required, configure the zone controller for proper operation on your conveyor using a configuration tool (pushbutton programmer or Genesis™ software) to perform this task. NOTE: The “Auto Configure” function may be used to quickly configure a controller to match other controllers on the conveyor. See page 32 for more information.

• Cordset Removal/Installation

The cordsets snap into the zone controller bases and connect to each other in a “daisy chain” fashion. The cordset may be installed in either of two mounting positions based on the required default direction of carton flow on the conveyor. The procedure for removal and installation of the cordset is as follows:

Cordset Removal

1. Remove power from the EZLogic® system.
2. Remove the zone controller from the cordset and base (see “Zone Controller Removal”).
3. Disconnect the connectors on the ends of the cordset from the adjacent cordsets. This connection may be a “push-on” type (standard) or “screw-on” type (optional). Disconnect the “push-on” type by pulling the connector from the adjacent cordset without twisting the connector. Disconnect the “screw-on” type by unscrewing the connector from the adjacent cordset.
4. Using your thumbs, push the two “movable” snap-mount tabs away from the cordset housing. At the same time, use a finger to gently pull the cordset housing away from the base until it releases.

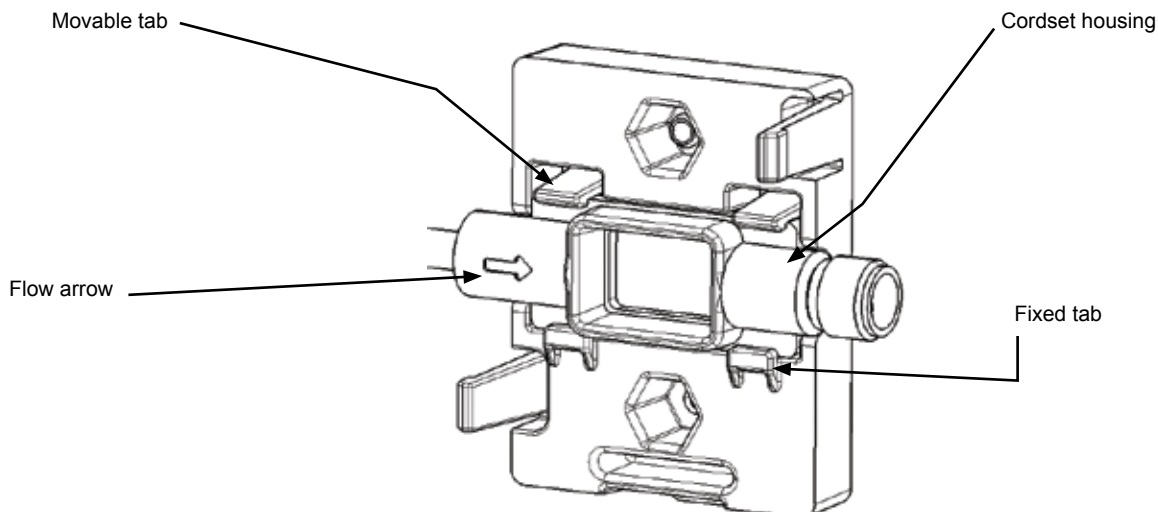

Figure 15—Cordset and Base



Cordset Installation

1. Locate the arrow on the cordset housing. This arrow indicates the default direction of carton flow on the conveyor.
2. With the arrow facing you and pointing in the direction of carton flow, install the cordset housing into the controller base by hooking the lower portion of the cordset housing under the stationary tabs, then pressing on the cordset until the movable tabs snap into place, securing the cordset housing in the base.
3. Connect to the adjacent cordsets on either side of the installed cordset. For push-type female connectors, rotate the connector until the triangle-shaped arrow is facing you, then push the connector onto the male connector. For screw-on type female connectors, rotate the connector until the keyway of the connector is facing you, insert the connector into the mating male connector, then finger-tighten the connector.
4. Replace the zone controller.
5. Return power to the EZLogic® system.

Base Removal/Installation

The zone controller base is typically mounted to the conveyor in an “accumulation channel” or other metal mounting hardware. Installation and removal of the base is as follows:

Base Removal

1. Remove the zone controller and cordset from the base (see “Zone Controller Removal” and “Cordset Removal”).
2. Using a drill, remove the rivet head(s) from the rivet(s) holding the base to the channel.
3. Remove the base from the accumulation channel.

Base Installation

1. Locate the mounting holes provided in the accumulation channel (or other provided mounting) for the base. NOTE: In the case of unitized zone controllers, the location of the base will determine the location of the sensor in the accumulation zone. The sensor is normally located near the downstream end of the accumulation zone, but this location can vary by application.
2. Attach the base to the accumulation channel using a 5/32” diameter pop rivet or a #8 machine screw (some installations may require two fasteners).
3. Install the cordset and the zone controller.

• IOP Unit and Related Cables

This section describes the proper installation and setup of the IOP unit and related cables. Failure to comply with the following guidelines may result in improper operation and possible damage to EZLogic® system components.

Installing the IOP Unit

The IOP unit must be located and installed properly to insure proper operation. The following rules should be observed when installing the IOP unit:

- Do not attempt to power more than 50 zone controllers from one IOP unit. NOTE: the use of some zone actuation devices and/or accessories may reduce this number.
- Do not exceed 25 zone controllers on either side of the IOP Tee cable. NOTE: the use of some zone actuation devices and/or accessories may reduce this number.
- Mount the IOP unit so that the mounting bolts are vertical and the labels are in an upright and readable position, as shown in Figure 16. DO NOT MOUNT THE IOP UNIT IN OTHER POSITIONS!



REMOVAL & INSTALLATION

Installing the IOP Unit Continued

- If multiple IOP units are required in the same zone controller chain, a power isolation cable or IOP isolation cable must be used between powered “regions” of the conveyor to prevent electrical interference between IOP units.
- If multiple IOP units are required in the same zone controller chain, the grounding jumper must be removed from all but one of the IOP units in the chain. This allows the chain to be grounded at a single point to prevent “ground loop” interference.



Figure 16—IOP Unit Mounting Position

To install the IOP unit to your conveyor, proceed as follows:

1. Locate a mounting area near the center of the conveyor (or the conveyor area being powered by the IOP unit). On new installations the IOP Tee cable will be pre-installed in the proper location.
2. Attach the IOP unit to the conveyor using at least two 3/8-16 x 1-inch long bolts. On most conveyor models the IOP unit bolts to the bottom flange of the conveyor side channel directly. On some models an extra bracket is used. Refer to the installation manual for your particular conveyor model for details.
3. Connect the long “leg” of the IOP Tee cable to the connector on the IOP unit. This is a screw-on connection.
4. Loosen the captive screws holding the end plate on the “switch end” of the IOP unit. You may leave one screw loosely screwed into the unit to allow the end plate to swing out of the way.
5. Wire 120 VAC or 230 VAC single-phase supply power to the terminals marked “L1,” “L2,” and “ \perp ” as shown in Figure 17. Use one of the 1/2” NPT threaded conduit holes provided to bring the wiring into the IOP unit.
6. If you wish to monitor the status of the DC power output of the IOP unit, connect two wires from the external control device (PLC) to the DC “health” terminals as shown in Figure 17. (Refer to page 59 for more information on the DC “health” output of the IOP unit.)
7. If the IOP unit is one of two or more IOP units on the same zone controller chain, remove the grounding jumper from all but one of the units as shown in Figure 17.
8. If the IOP unit is to be used as a wiring hub for IOP control wiring, re-position the IOP-enable jumper. (Refer to the EZLogic® IOP Solutions manual for more information.)
9. Replace the end plate and tighten the captive screws.

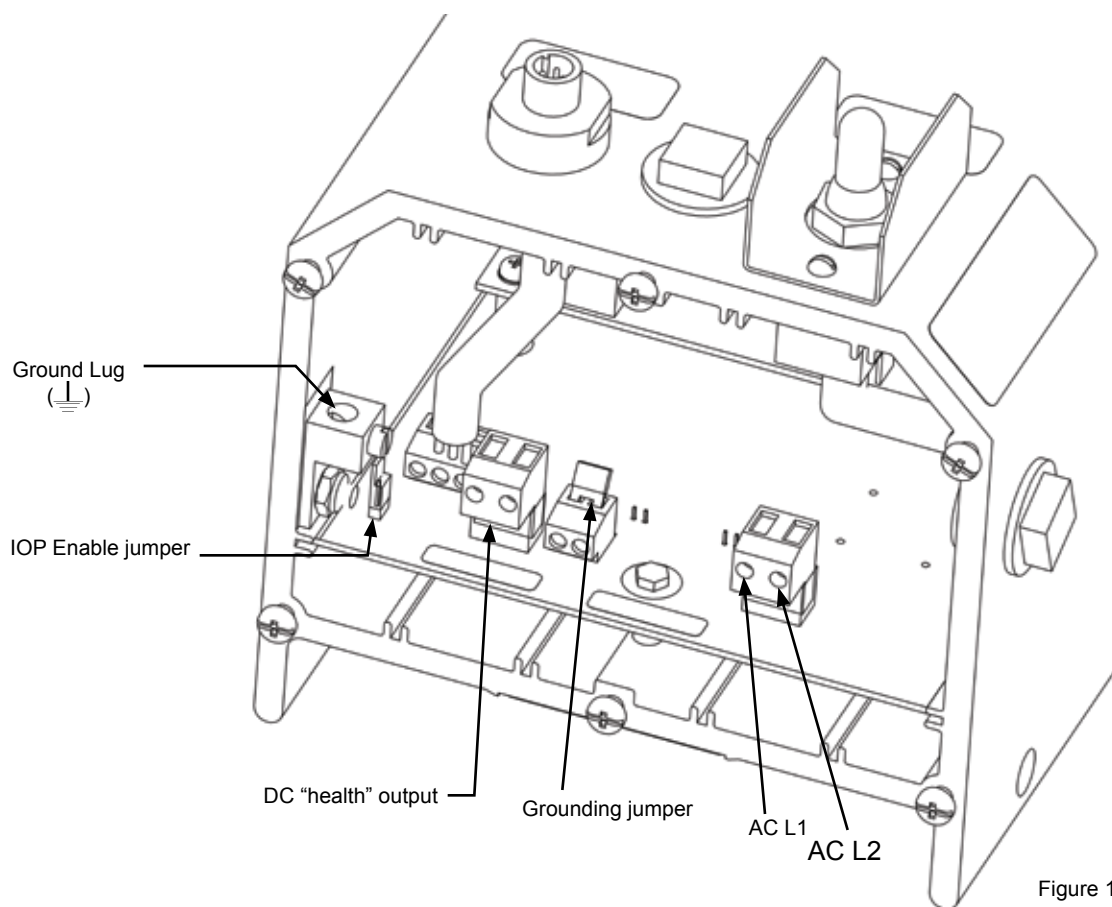

Figure 17—IOP Power Connections

Installing the IOP Tee Cable

New conveyors shipped from the factory normally have the IOP Tee cable pre-installed. If there is a need to install the IOP Tee cable in an existing zone controller chain, use the following procedure:

1. Choose an installation point so that no more than 25 zone controllers will be powered by one “leg” of the Tee cable. In most cases the best location is near the center of the conveyor. This allows up to 50 zone controllers—25 on each side of the Tee—to be powered through one IOP Tee cable.
2. “Break” the cordset chain by disconnecting the female connector of one cordset from the male connector of the adjacent cordset.
3. Install the IOP Tee cable into the cordset chain by connecting the two short “legs” to the male and female connectors of the cordsets you disconnected in step 2.
4. Connect the long “leg” of the IOP Tee cable to the IOP unit.

Installing Isolation Cables

Isolation cables must be used when multiple IOP units are installed on one continuous zone controller chain. There are two types of isolation cables:

- **Power Isolation Cables** prevent power from “passing through” from one powered region to another, while allowing normal zone communication and IOP control communication to pass. Use this cable for most multiple-IOP applications.
- **IOP Isolation Cables** prevent power from passing through like power isolation cables, but also prevent IOP communications from passing between regions. Normal zone communication is allowed to pass. This cable is used when more than one IOP unit is used as a wiring hub on the same zone controller chain. Refer to the EZLogic® IOP Solutions manual for more information.

REMOVAL & INSTALLATION

Use the following procedure to locate and install an isolation cable:

1. If the two IOP units being isolated are on separate conveyors end-to-end, the isolation cable is normally installed at the joint between the two conveyors. If the two IOP units are on the same conveyor, locate the isolation cable near the midpoint between the two IOP units. NOTE: In either case, do not exceed 25 zone controllers between each IOP Tee cable and the isolation cable.
2. "Break" the cordset chain by disconnecting the female connector of one cordset from the male connector of the adjacent cordset.
3. Install the isolation cable into the cordset chain by connecting the isolation cable to the male and female connectors of the cordsets you disconnected in step 2.

• Connecting to External Controls

This section describes how to connect external control devices, such as PLCs, switches, etc, to a zone controller using the auxiliary port of the zone controller. For information about connecting to external controls using the IOP control wiring system, refer to the EZLogic® IOP Solutions manual.

Connecting Inputs Using the Auxiliary Input Cable

The auxiliary input cable plugs into the auxiliary port of any EZLogic® zone controller and is terminated on the other end by a two-wire "pigtail." These wires accept only a "dry contact" type input signal. That is, the zone controller receives an "active" input signal when the two wires are "shorted" together through a switch, a relay (mechanical or solid state), or by simply twisting the wires together. The connection is not polarity sensitive.

By default, an active input to a zone controller is interpreted as a "zone stop" signal by the controller. The zone controller may be configured to interpret this signal as another type of input, such as "slug mode." Refer to the "Zone Controller Configuration" section for more information about configuring the auxiliary input signal.

To install the auxiliary input cable:

1. Locate the zone controller where an input is required.
2. If necessary, configure the zone controller for the desired input using a pushbutton programmer or a pc and Genesis™ Configuration software.
3. Connect the brown and blue wires of the auxiliary input cable to the signal source. If the signal source is located some distance away, use "twisted pair" two-wire cable between the auxiliary input cable and the signal source.
4. Plug the auxiliary input cable to the auxiliary port of the zone controller.

NOTE: Do not apply a voltage to these wires, or wire more than one auxiliary input to any one contact.

Connecting Inputs and Outputs Using the Auxiliary I/O Module

The auxiliary I/O module has two cables. One is terminated by a connector and plugs into the auxiliary port of any EZLogic® zone controller. The other is terminated with a six-wire "pigtail." These wires are divided into three pairs. Each pair is used for a different type signal:

- Brown and Blue—Used when the external signal is a "dry contact" type input. This input is identical to the one provided by the auxiliary input cable.



-
- White and Gray—Used when the external signal is “voltage” type input. This input is considered “active” by the zone controller when an 18-30 VDC signal is placed across these wires.
 - Orange and Violet—Used to provide an output to an external device. This output is a solid state relay, or “dry contact” type, rated for up to 30 VDC, 80mA maximum.

By default, an active input to the auxiliary I/O module on either the “brown and blue” pair or the “white and gray” pair is interpreted by the zone controller as a “zone stop “ signal. The zone controller may be configured to interpret this signal as another type of input, such as “slug mode.” Refer to the “Zone Controller Configuration” section for more information about configuring the auxiliary input signal.

The default output of the zone controller through the auxiliary I/O module is a “transducer” or “photo-eye” output, active (“contact closed”) when an object is detected by the zone controller’s transducer. The zone controller may be configured to provide other types of output signals, such as a “zone blocked and stopped” signal. The “contact closed” or “contact open” state of the output may also be configured. Refer to the “Zone Controller Configuration” section for more information about configuring the auxiliary output signal.

To install the auxiliary I/O module:

1. Locate the zone controller where an input is required.
2. If necessary, configure the zone controller for the desired input and/or output using a pushbutton programmer or a pc and Genesis™ Configuration software.
3. Connect the required wire pair(s) to the external control device. **Important!** Make sure that the correct signal type is connected to the correct wire pair(s).
4. Plug the other cable of the auxiliary I/O module to the zone controller.
5. Mount the auxiliary I/O module to the conveyor accumulation channel (or other provided mounting), if desired, by snapping the module into the square hole in the channel.



CONFIGURABLE FEATURES

The GEN3 EZLogic® accumulation system offers the user great flexibility in the way the conveyor transports, accumulates, and releases product. It also provides special features to facilitate product loading, unloading, counting, indexing, and many other functions normally requiring external controls devices.

The EZLogic® system comes pre-configured with the most common settings for your particular model. In many instances, no further configuration is needed at installation.

Many configuration settings may be changed using the **EZLogic® pushbutton programmer**. These settings and many more may be configured using a computer and Hytrol's "**Genesis™ Configuration Manager**" software and interface cable kit.

In this section each configurable operating feature is described along with the available settings for each feature. For each feature that may be configured with the pushbutton programmer the heading for that feature will include a function number associated with that function.

Sleep Feature

PB: Function 1

Pushbutton Programmer	Genesis™
1 = 0 (disabled) 2 = 5 seconds 3 = 15 seconds 4 = 30 seconds	0 (disabled) to 60 seconds, 1 second increments

When this feature is enabled, the EZLogic® zone controller will stop the zone rollers from turning if no cartons are detected for a set time period. The zone “wakes up” when product is detected in one of the two adjacent upstream zones or by the zone where the zone controller is located. This feature increases roller life while reducing noise and energy consumption.

The time between when the zone controller and its upstream neighbors last detect a carton and when the zone “goes to sleep” may be set to zero (sleep feature disabled), 5, 15, or 30 seconds using the pushbutton programmer, or from zero to 60 seconds with Genesis™. The controller’s default setting is five seconds. However, this setting may be altered from the factory to best fit the standard operation of a particular EZLogic®-equipped conveyor. For conveyors where the drive load decreases when the zone is sleeping, such as the model ABEZ, the default setting of five seconds is typically used. For conveyors where the drive load increases when the zone is sleeping, such as the model 190 NSPEZ, this function is set to “sleep feature disabled.”

Singulate/Slug

PB: Function 2

Pushbutton Programmer	Genesis™
1 = Follow 2 = Singulate Only 3 = Slug Only	Follow , Singulate Only, Slug Only



This function is used to select the desired mode of operation for a particular zone controller. The following choices are available:

- **Follow (default).** With this setting selected, the zone controller will follow the state of a slug input signal, if present, as provided through an auxiliary input cable, auxiliary I/O module, or IOP signal to a properly-configured zone controller somewhere in the controller chain. If there is no active slug signal the zone controller will default to singulation mode. If the input is active, the zone controller will operate in slug mode.
- **Singulate.** With this setting selected, the zone controller will operate in singulation mode, regardless of the status of the slug input signal.
- **Slug.** With this setting selected, the zone controller will operate in slug mode, regardless of the status of the slug input signal. This setting may be used with all of the zone controllers in a chain to cause the conveyor to operate in slug mode all the time, eliminating the need for the optional slug input signal.

All zone controllers in a chain may be set to the same singulate/slug setting, or any combination of zone controllers may be set to follow, singulate, or slug. This provides great flexibility in controlling the way cartons flow on the conveyor. For example, a portion at the discharge end of the conveyor may be set to slug mode to provide a high through-put of boxes for a short time, while the rest of the conveyor may be set to singulate mode, giving greater control of individual cartons.

Zone Output Mode

PB: Function 6

Pushbutton Programmer	Genesis™
1 = Off to Stop 2 = On to Stop	Off to Stop On to Stop

This function is used to select whether the zone controller’s output to the zone actuation device in the zone is ON TO STOP the zone or OFF TO STOP the zone. This feature allows the EZLogic® system to be used in conjunction with “normally open” or “normally closed” air valves, different conveyor types, etc.

The zone controller’s default setting for this function is “ON TO STOP” the zone. However, this function will be set at the factory to the proper setting for the conveyor on which the zone controller is installed. There is usually no need to change this function from its factory setting, except when replacing a zone controller on some conveyors.

Jam Protection

PB: N/A

Pushbutton Programmer	Genesis™
Not available	Disabled Enabled

This function enables or disables the “jam protection” feature for that zone controller. This feature, only available in slug mode, helps prevent product pile-up and/or damage if a carton should become jammed on the conveyor. If the conveyor is operating in “slug mode” and a carton becomes jammed, the zone controller that is detecting the jammed carton will allow six seconds for the carton to move on. If the carton is still present after six seconds, the zone controller sends a signal to the upstream zone to accumulate any incoming product until the jam is cleared. The “jammed” zone continues to drive in an attempt to clear the jam. The default factory setting for this function is “ENABLED”.



CONFIGURABLE FEATURES

Diffuse Sensitivity Setting

PB: Advanced 1

Pushbutton Programmer	Genesis™
1 = Maximum sensitivity 5 = Default ----- 8 = Minimum sensitivity	1 (maximum sensitivity) to 8 (minimum sensitivity)

The diffuse versions of the EZLogic® transducers (sensors) detect objects by bouncing an infrared light beam off the object back to the sensor. The ability of the module to detect objects varies greatly with the reflectivity (color, shininess) of the object and the distance from the sensor.

Standard diffuse sensors have eight different sensitivity settings, numbered 1 (maximum sensitivity) to 8 (minimum sensitivity). The default sensitivity setting is five.

The actual maximum distance at which an object will be detected at a given sensitivity setting is dependent upon the color, surface texture, and shininess, as well as the angle of the reflecting surface to the sensor. The following charts show the nominal maximum distance to detect a 90% reflectance object (clean white paper) at each sensitivity setting, and the maximum distance to detect various objects at sensitivity setting 5.

NOTE! These numbers are for reference only. The actual distance will vary depending on the actual object being detected.

DIFFUSE SENSITIVITY SETTING	NOMINAL DISTANCE TO A WHITE PAPER TARGET
1	48"
2	39"
3	31"
4	24"
5	20"
6	15"
7	12"
8	9"

OBJECT	NOMINAL DISTANCE TO OBJECT AT SENSITIVITY SETTING 5
White Paper	20"
Brown Cardboard Box	18"
Brown Cardboard with Clear Plastic Tape	54"
Powder-Painted Metal (green)	24"



The proper setting to use must be determined at installation with the actual product being conveyed and with any “background” objects, which must NOT be detected, in place.

Zone Operational Mode

PB: Function 7

Pushbutton Programmer	Genesis™
1 = Fixed Zone Length 2 = Dynamic Zone Length	Fixed Zone Length Dynamic Zone Length

The EZLogic® zone controllers may be set to operate in “fixed zone length” or “dynamic zone length” while the conveyor is running in singulation mode.

Fixed Zone Length

When the zone operating mode is set to “fixed zone length” each carton is assigned one mechanical zone (the zone length determined by the mechanical “build” of the conveyor) as it is transported and accumulated. The zone length must be longer than the longest carton to be conveyed. When cartons are transported or released, a gap equal to the length of one mechanical zone is created between the cartons.

Dynamic Zone Allocation (default)

When the zone operating mode is set to “dynamic zone length” EZLogic® uses a process known as “dynamic zone allocation” to adjust the zone length to fit the carton being conveyed.

The mechanical zone length (determined by the mechanical “build” of the conveyor) becomes the “base” zone length when using dynamic zone allocation. Each carton is assigned enough “base” zones to accommodate its length. For example, if the conveyor is built up using 12-inch “base” zones, a 9-inch box will be assigned one “base” zone, or 12 inches, while a 21” box will be assigned two “base” zones, or 24 inches. The cartons are thus allocated the proper number of “base” zones as required by the cartons.

As cartons are transported or released, a gap equal to the length of one “base” zone is created between the cartons, regardless of the carton length.

If the zone controller is operating in “slug mode,” dynamic zone allocation is not required and is disabled.

Sensor Configuration

PB: N/A

Pushbutton Programmer	Genesis™
Not Available	Sensor #1 only , Sensor #2, Sensor #1 OR Sensor #2, Sensor #1 AND Sensor #2

A feature that adds much flexibility to the EZLogic® GEN3 accumulation system is the ability to use remote zone controllers and the remote “dual sensor” option. This option allows two sensors (transducers) to be used with one zone controller.



CONFIGURABLE FEATURES

When using dual sensors, the controller may be configured to use only one of the two sensors, or it may be set up so that if EITHER sensor #1 OR sensor #2 is blocked a carton is considered “detected. It may also be configured so that BOTH sensor #1 AND sensor #2 must “see” the carton before it is “detected.”

This setting is configured at the factory and does not normally require configuration.

Zone Stop Mode

PB: N/A

Pushbutton Programmer	Genesis™
Not Available	Static (normal mode) , Indexing (1-to 60-box release)

By default, an active “zone stop” signal to a zone controller causes that controller to stop the zone whenever a carton is detected in the zone. As long as the zone stop signal is active the stopped carton will be held. When the zone stop signal becomes inactive the carton is released; that is, the zone is restarted to advance the carton (provided that there is not a carton occupying the adjacent downstream zone). This zone stop mode is known as **static** zone stop mode.

In **indexing** zone stop mode, the user selects a minimum number of cartons to release any time the zone stop signal is “cycled” from active to inactive and back to active. As long as the zone stop signal is active the cartons are held. When the zone stop signal is momentarily cycled to “inactive” the zone controller will release the number of cartons selected, and stop the next carton. For example, if the zone stop mode is set for “1 box release” one carton will be released when the signal is cycled.

Accumulation Delay

PB: Function 3

Pushbutton Programmer	Genesis™
1 = Disabled 2 = Delay Zone Accumulation 3 = Delay During Transport Only	Disabled , Delay Zone Accumulation, Delay During Transport Only

The accumulation delay can be set to operate in two ways. “Delay zone accumulation: will cause a zone to drive 1.8 seconds after normal accumulation would have occurred. It may be used to “crowd” cartons on the conveyor. “Delay during transport only” inhibits normal singulation of cartons during transport, but does not inhibit normal product accumulation. Both provide a singulated release of cartons. The default setting for the accumulation delay is **disabled**.

Loading Zone

PB: N/A

Pushbutton Programmer	Genesis™
Not available	0 (disabled) to 60 seconds, in 1 second increments



The loading zone function is a “smart” timer function designed for pallet-handling applications. When this function is enabled in a zone controller, if a load is placed in the zone and is detected by the zone controller sensor the zone controller will stop the rollers from turning in the zone and signal the immediate upstream zone to hold back any incoming loads for a user-selectable time. This allows time for the fork truck (or other loading mechanism) to position and pull clear of the load before the conveyor attempts to advance the load down the conveyor.

The zone controller is able to distinguish a load being placed on the conveyor from a load that is already being transported by the conveyor and only triggers the loading zone function for loads placed on the conveyor.

The loading zone function may be used in an infeed zone or any intermediate zone of the conveyor, and may be cloned to all zones in the conveyor to allow for “random access” loading.

Unloading Zone

PB: Function 4

Pushbutton Programmer	Genesis™
1 = 0 (disabled) 2 = 15 seconds 3 = 30 seconds 4 = 45 seconds	0 (disabled) to 60 seconds, in 1 second increments

When this feature is enabled, if an accumulated load is removed from the conveyor manually, the zone where the load is removed and the zone immediately upstream from the removed load will delay driving for a set time, allowing the load to be safely removed before the next load advances. This feature is ideal for pallet-handling conveyors where loads are routinely removed from the conveyor with a fork truck. By using the built-in delay, unloading zones may be created without any extra controls. Every zone on the conveyor may be set to use the delay, making it possible to unload from any zone safely.

The unloading zone function is implemented only when a load is removed from the conveyor. If a load is driven out of a zone because of a zone stop signal being removed or during normal transport, there is no delay in zone start-up.

Auxiliary Input Mode

PB: Function 2

Pushbutton Programmer	Genesis™
1 = Zone Stop 2 = Slug Input 3 = Zone Wake-up 4 = Logic Only Input	Zone Stop , Slug Input, Zone Wake-Up, Logic Only Input, Direction of Flow

The auxiliary port of any EZLogic® zone controller may be used to provide an input to the zone controller. This input may be connected to the controller using an auxiliary input cable, an auxiliary I/O module, or an auxiliary photo-eye. The zone controller may be configured to interpret this input as one of the following types:

- **Zone Stop (default)**—This input is used to control the zone stop function of a zone controller. An active input “arms” the zone stop function. When the input is active the zone controller will stop the zone from driving when it detects a carton in the zone. This input is used in the discharge zone of the conveyor to control the release of product. It may also be used anywhere on the conveyor where the ability to stop a carton is required, such as merge points, workstations, etc.



CONFIGURABLE FEATURES

If the zone controller is labeled as series A3 or higher (and/or Genesis™ indicates that the firmware revision of the controller as 2.0 or higher) then the default behavior of the zone stop function may be selected using the Genesis™ software. The choices are:

- **Zone Stop Signal “Active to Stop” (default)**—An active input to the controller “arms” the zone stop function to stop the next carton detected. When the signal is inactive, cartons flow through normally. This is the same as earlier EZLogic® versions.
- **Zone Stop Signal “Active to Run” (“failsafe”)**—The zone stop function is “armed” when the input is inactive. An active input to the controller “disarms” the zone stop feature. This means that a carton that enters the zone will be stopped by default. An active signal is required to release the carton. This setting may be used at the discharge zone of any conveyor when it is important that product is held back should a controls failure occur.
- **Slug Input**—An active input to this controller generates a “slug” signal that is sent to all controllers in the chain. All controllers with the “singulate/slug” function set to “follow” will detect this signal and begin operating in slug mode. When the signal becomes inactive the zone controllers revert to singulation mode. Any controllers with the “singulate/slug” function set to “singulate only” or “slug only” will ignore this signal.
- **Zone Wake-Up**—An active input to the controller will cause the zone to “wake up” if the sleep feature is active. This setting may be used in any zone, but is primarily used in the infeed zone of pallet-type conveyors. By default, the infeed zone of a zone controller chain will remain “awake” to allow loads to enter the conveyor. By setting the auxiliary input to “zone wake-up” the zone is allowed to “go to sleep”. An input to the controller from an auxiliary photo-eye or other input source will cause the zone to “wake up” in order to transport a load onto the conveyor.
- **Logic Only Input**—An active input is used as an input to a special logic function. This setting will normally be configured automatically when the special logic function is set up. The action performed by this input is determined by the special logic function used.
- **Direction of Flow**—An active input to the controller generates a “reverse direction” signal that is sent to the other zone controllers in the chain. To use the reverse feature, the following components must be used:
 - Enhanced remote zone controllers (032.507), Series A3 (firmware revision 2.0) or later, in all zones of the reversing conveyor
 - Dual transducers in all zones
 - Genesis™ software and PC adapter (to configure this setting)

If a reverse input is inactive, EZLogic® operates in the default forward direction (defined by the way the cordsets are installed) using transducer #1 as the sensor. If a reverse input is active, EZLogic® operates in the reverse direction, using transducer #2 as the sensor. NOTE: The directional input signal only affects the logical operation of the EZLogic® controls. It does not reverse the direction of the conveyor’s drive mechanism. The conveyor drive itself must be reversed to operate in the reverse direction.

Auxiliary Output Mode

PB: N/A

Pushbutton Programmer	Genesis™
Not Available	Photo-Eye Beam Status, Zone Blocked and Stopped, Directional Mode, Configurable Logic Output



The auxiliary port of any EZLogic® zone controller may be used to provide an output from the zone controller. This output may be retrieved from the controller using an auxiliary I/O module. The zone controller may be configured to provide one of the following types of outputs:

- **Photo-eye Beam Status (default)**—An output signal is given when the zone controller's transducer (sensor) detects a carton.
- **Zone Blocked and Stopped**—An output signal is given when the zone controller actually accumulates a carton. That is, the output signal only becomes active when the zone controller detects a carton AND the zone controller has stopped the carton. This output is very useful as a "lane full" indication.
- **Directional Mode**—An output signal is given when the zone controller is operating in reverse mode. This output may be used when an action needs to be triggered on another conveyor or other device when the conveyor is operating in reverse mode. NOTE: reverse mode is only available when using enhanced remote zone controllers (032.507) labeled Series A3" or later (and/or with firmware revision 2.0 or later) and dual transducers.
- **Configurable Logic Output**—An output signal is generated by a special logic function. This setting will normally be configured automatically when the special logic function is set up. The action performed by this output is determined by the special logic function used.

• Special Logic Functions

In addition to the functions built into the EZLogic® zone controllers, the Genesis™ configuration software provides other functionality that can be loaded into the controllers to expand the capabilities of the EZLogic® system even further. These are known as special logic functions.

Several special logic functions are included with the Genesis™ installation. Other functions are periodically released as they are developed. These may be obtained by using the "check for updates" feature of Genesis™. Please refer to the "Genesis™ Configuration Software" section of this manual for more details about updates.

Standard EZLogic® zone controllers may be configured with one special logic function, while enhanced zone controllers may be configured with up to four. Some special logic functions may only be used with enhanced controllers, while others may be used in all zone controllers.

The following special logic functions are included in the Genesis™ installation:

Cascade Release (for Slug Mode)

Normally when cartons are released from a conveyor operating in slug mode all cartons are released simultaneously. This often results in cartons being back-to-back as they exit the conveyor.

The cascade release function introduces a delay in the release of each zone from the discharge end upstream. This delay creates a separation of cartons similar to singulation, except that the space between the cartons is based on the length of the delay rather than the zone length. By using a short delay a small gap may be created, which can improve carton travel through curves and merges. A longer delay can create larger gaps for other operations.

The cascade release function also reduces maintenance on the conveyor by decreasing the amount of shock loading on the drive components during product start-up. By releasing the cartons sequentially rather than simultaneously there is less stress placed on belts, chains, etc.



CONFIGURABLE FEATURES

Brake Pulse (for gravity conveyors)

When the EZLogic® system is used with gravity conveyors to control product flow it is important to control the momentum of the cartons as they travel down the conveyor. The pulse function momentarily applies a brake to passing cartons to reduce this momentum. The function may be used in any or all zones of the gravity conveyor, as required.

PE (Photo-Eye) On Delay

This function, when used in conjunction with an auxiliary I/O module, provides the user with an output if the sensor of the zone controller detects a carton for more than a chosen delay. For example, if the function were set up with a delay of 2 seconds, a carton would have to be detected by the zone controller for more than 2 seconds before the output would become active. The output becomes inactive when the carton is no longer detected.

PE (Photo-Eye) Off Delay

This function, when used in conjunction with an auxiliary I/O module, provides the user with an active output if the sensor of the zone controller detects a carton. When the carton is no longer detected, the signal remains active for the duration of the chosen delay. For example, if the function were set up with a delay of 2 seconds, the output would remain active for 2 seconds after the carton has cleared the sensor.

Zone Kill

This function is triggered by an auxiliary input signal to the zone controller. When this function is “loaded” into a zone controller and the auxiliary input is active, the following two things occur:

1. The zone controller immediately stops the drive in the zone it controls.
2. The zone controller sends a signal to the adjacent upstream zone controller to stop and hold any incoming cartons.

This function has several possible uses. The following are examples:

- As an alternative to the loading and unloading zone functions. A signal may be given to the controller by an outside control source, such as a photo-eye set to detect the presence of a fork truck. This provides a positive control of the zones instead of the timer approach used by the loading and unloading functions.
- In high-speed applications the zone kill function may be used to improve stopping control at the discharge end of a conveyor. By providing a “dead” zone at the end of the conveyor the function can greatly reduce problems caused by carton “drift” during accumulation.

• Controller Setup Functions

Controller setup functions simplify the process of configuring EZLogic® zone controllers by providing a way to use settings from one zone controller in other controllers, or to configure some or all of the controllers in a chain at one time.

Clone

PB: Advanced 3

Pushbutton Programmer	Genesis™
Clone Upstream	Clone Upstream, Clone Downstream, Clone Both Directions



In most cases all of the zone controllers in an EZLogic® system are configured identically. The clone function takes configuration settings from one zone controller and copies, or “clones” those settings to other zone controllers in the same zone controller chain. This makes it easy to make changes to all, or a large portion, of the zone controllers.

The following chart shows the settings that are cloned by the pushbutton programmer and Genesis™.

Pushbutton Programmer	Genesis™
<p style="text-align: center;">Sleep Timer Singulate/Slug Zone Output Mode Jam Protection Status Diffuse Sensitivity Zone Operating Mode Sensor Configuration Accumulation Delay Unloading Zone</p>	<p style="text-align: center;">Sleep Timer Singulate/Slug Zone Output Mode Jam Protection Status Diffuse Sensitivity Zone Operating Mode Sensor Configuration Accumulation Delay Unloading Zone Zone Stop Mode Loading Zone Special Logic Functions</p>

There are some configuration settings that are considered “local” settings only. These settings are NOT cloned to other zone controllers. These settings include:

- Auxiliary Input Mode
- Auxiliary Output Mode
- IOP configuration settings

Reset Functions

PB: Advanced 4, 5, 6, 7

Pushbutton Programmer	Genesis™
<p>Advanced 4 = ABEZ Advanced 5 = NSPEZ (all), DCEZ (all) Advanced 6 = CCEZ Advanced 7 = 25 LREZ, CREZD (all), PREZ, PLEZD</p>	<p style="text-align: center;">Default configurations for each model</p>

Hytrol offers several different styles of zero-pressure accumulation conveyors, ranging from belt- and lineshaft-driven live-roller package-handling conveyors to chain-driven live-roller pallet-handling conveyors and accumulating drag-chain conveyors. EZLogic® is designed to accommodate the unique requirements of each of these conveyor styles.

The programming tool being used to configure the EZLogic® system provides an easy way to apply the proper “conveyor model defaults” to the zone controllers. The method used is determined by the tool.



CONFIGURABLE FEATURES

Pushbutton Programmer

The pushbutton programmer provides the user with four reset functions that are designed to automatically select the most commonly used function settings for each of the different conveyor styles and copy them to all upstream zone controllers in the chain. These reset functions may be used to quickly configure all zones in the conveyor to match the conveyor's style, or to restore the conveyor to its "factory default" configuration.

It is important to note again that the reset functions affect the zone controller being programmed and all zone controllers **upstream of it in the chain**. By using a reset function at the most downstream zone controller in the chain (in the discharge zone of the conveyor) all zones in the chain may be reset.

Genesis™ Configuration Software

Genesis™ provides the user with a list of conveyor models to choose from. Choosing a conveyor model configures the connected zone controller with the "factory default" settings for that conveyor model. This configuration may then be cloned to the other zone controllers in the chain.

Refer to the "Genesis™ configuration software" section for more information.

Auto Configure

PB: Advanced 8

Auto Configure is a very useful function when there is a need to replace an EZLogic® zone controller. When this function is selected the zone controller retrieves the configuration of one of the two adjacent zone controllers. This configuration is then applied to the zone controller. This provides an easy way to configure a replacement zone controller for your particular application.

This function is available with both the pushbutton programmer and Genesis™ software.



• Configuring a Zone Controller with the Pushbutton Programmer

The EZLogic® pushbutton programmer may be used to configure the basic functions of an EZLogic® zone controller. This section describes how to use the pushbutton programmer to display current setting configurations and how to select and change settings. Also included in this section are programming examples showing the step-by-step procedure used to configure a zone controller.

Displaying Current Settings

When the pushbutton programmer is first connected to a zone controller the three indicator LEDs on the programmer show the current status of the controller, mirroring the behavior of the LEDs on the controller and transducer. Figure 18 shows what the LEDs indicate in this mode.

To display the current settings that can be changed with the pushbutton programmer, press and hold one of the two buttons on the programmer. Each button causes a different portion of the setting information to be displayed:

Left button pressed:

- Green LED—Sleep Timer
- Yellow LED—Zone Output Mode
- Red LED—Zone Operating Mode

Right button pressed:

- Green LED—Accumulation Delay
- Yellow LED—Singulate/Slug
- Red LED—Unloading Zone

Refer to Figures 19 and 20 for information on how to interpret the LEDs.

<p style="text-align: center;">GREEN LED</p> <p>STEADY ON = POWER ON FAST FLASH = JAM DETECTED SLOW FLASH = LOW VOLTAGE (<20V) QUICK FLASH "ON" = CONTROLLER IS "ASLEEP" QUICK FLASH "OFF" = AUX INPUT SET FOR "SLUG INPUT"</p>
<p style="text-align: center;">YELLOW LED</p> <p>STEADY ON = BEAM COMPLETE/NO OBJECT DETECTED STEADY OFF = BEAM BLOCKED/OBJECT DETECTED</p>
<p style="text-align: center;">RED LED</p> <p>STEADY ON = ZONE DRIVING STEADY OFF = ZONE STOPPED SLOW FLASH = ZONE ACTUATION DEVICE NOT DETECTED OR OPEN FAST FLASH = ZONE OUTPUT SHORTED</p>



Figure 18—Indicator LEDs—Normal Operation

CONFIGURING

GREEN LED
DISPLAYS SLEEP TIMER SETTING
1 FLASH = SLEEP DISABLED
2 FLASHES = 5 SECONDS
3 FLASHES = 15 SECONDS
4 FLASHES = 30 SECONDS

YELLOW LED
DISPLAYS ZONE OUTPUT STATE
STEADY ON = "ON TO STOP"
STEADY OFF = "OFF TO STOP"

RED LED
DISPLAYS ZONE OPERATING MODE
STEADY ON = DYNAMIC ZONE LENGTH
STEADY OFF = FIXED ZONE LENGTH



Figure 19—Indicator LEDs—Left Button Pressed



GREEN LED

DISPLAYS ACCUMULATION DELAY SETTING

1 FLASH = DISABLED

2 FLASHES = DELAY ZONE ACCUMULATION

3 FLASHES = DELAY DURING TRANSPORT ONLY

YELLOW LED

DISPLAYS SINGULATION/SLUG MODE SETTING

1 FLASH = FOLLOW

2 FLASHES = SINGULATE ONLY

3 FLASHES = SLUG ONLY

RED LED

DISPLAYS UNLOADING SETTING

1 FLASH = DISABLED

2 FLASHES = 15 SECONDS

3 FLASHES = 30 SECONDS

4 FLASHES = 45 SECONDS



Figure 20—Indicator LEDs—Right Button Pressed

• Selecting and Changing Settings

Selecting and changing the settings of an EZLogic® zone controller using the pushbutton programmer is designed to be straightforward. All programming is done through the two programming pushbuttons. During programming, the LED's provide a visual feedback.

To prevent unintentional re-programming of features, both pushbuttons must be pressed and held for at least one second before the programmer enters programming mode. Programming mode is exited by again pressing and holding both pushbuttons. The programmer will automatically exit programming mode if there is no pushbutton activity for 30 seconds. As an extra precaution, all clone and reset functions must be "confirmed" by pressing and holding both pushbuttons. This helps prevent changing all of the zone controllers inadvertently.

The diffuse sensitivity, auxiliary input, clone, reset, and auto configure functions are considered advanced commands, and are accessed by placing the programmer in advanced programming mode. Other functions are accessed in normal programming mode.



CONFIGURING

Basic Configuration Procedure

The basis procedure for configuring, or programming, a zone controller with the pushbutton programmer is shown in the following table.

In Order to . . .	Do the following . . .	Resulting LED Feedback
Enter programming mode	Hold both pushbuttons down for greater than 1 second	All three LED's will flash twice then strobe sequentially left to right once, then extinguish. After one second the green LED will flash once indicating that you are at function # 1.
Select the desired function	Press the left button to increment the function number (pushing the button increments the function from 1 to 2, etc.)	The green LED flashes to indicate the selected function number. (For example, if function 3 is selected, the LED will flash 3 times.)
Accept the selected function	Press the right button	The LED's will strobe sequentially left to right twice and then extinguish. After one second, the green LED will flash once to indicate setting #1 for the selected function.
Select the desired setting for the function	Press the left button to increment the setting number (pushing the button increments the setting from 1 to 2, etc.)	The green LED flashes to indicate the selected setting number. (For example, if setting 3 is selected, the LED will flash 3 times.)
Accept the selected setting	Press the right button	The LED's will strobe sequentially right to left twice and then extinguish. After one second, the green LED will flash once indicating that you are back at function #1.
Select Advanced Programming Mode	Select the Advanced programming mode function (function # 8) with the left button and accept it with the right button	The LED's will strobe sequentially right to left twice and then extinguish. After one second, the red LED will turn on (indicating that you are in advanced programming mode) and the green LED will flash once, indicating that you are at advanced function # 1.
Select a clone or reset function	In advanced programming mode, press the left button to increment the function number (pushing the button increments the function from 1 to 2, etc.)	The green LED flashes to indicate the selected function number. (For example, if function 3 is selected, the LED will flash 3 times.)
Accept the selected clone or reset function	Press the right button	The LED's will strobe sequentially right to left once and then the yellow LED will turn on, indicating that this function must be confirmed.
Confirm the clone or reset function	Press and hold both pushbuttons down for greater than 1 second	The LED's will strobe sequentially right to left once then all three LED's will flash until the keys are released.
Abort the clone or reset function	Press either button for greater than 1 second. This aborts the command (clone or reset commands only) and returns to normal programming mode.	All three LED's will flash three times then strobe sequentially left to right once and then extinguish. After one second, the green LED will flash once, indicating that you are at normal function #1.
Exit programming mode	Hold both pushbuttons down for greater than 1 second or do not push a button for greater than 30 seconds	All three LED's will flash twice then strobe sequentially right to left once and then resume normal operation



Configurable Functions and Settings

The following table shows the functions that are configurable with the pushbutton programmer and their associated settings. Bold type indicates a factory “default” setting for the function.

Function	Function #	Available Settings
Sleep Feature	1	1 = Sleep disabled 2 = 5 seconds 3 = 15 seconds 4 = 30 seconds
Singulate/Slug Mode	2	1 = Follow 2 = Singulate only 3 = Slug only
Accumulation Delay Timer	3	1 = Disabled 2 = Delay zone accumulation 3 = Delay during transport only
Unloading Zone Timer	4	1 = Disabled 2 = 15 seconds 3 = 30 seconds 4 = 45 seconds
Display Diffuse Range Setting	5	None (flashes yellow LED to show current diffuse range setting)
Solenoid Output	6	1 = Off to stop 2 = On to stop
Zone Operating Mode	7	1 = Fixed zone length 2 = Dynamic Zone Length
Advanced Programming Mode	8	None (Allows access to advanced commands)
Diffuse Sensign Range	Advanced 1	1 = Maximum Calibrated Range ----- 8 = Minimum Calibrated Range
Auxiliary Input Function	Advanced 2	1 = Zone stop input 2 = Slug input 3 = Zone wake-up
Clone Function	Advanced 3	Confirmation Required
Reset #1 (ABEZ)	Advanced 4	Confirmation Required
Reset #2 (NSPEZ, DCEZ)	Advanced 5	Confirmation Required
Reset #3 (CCEZ)	Advanced 6	Confirmation Required
Reset #4 (LREZ, CREZD, PREZ, PLEZD)	Advanced 7	Confirmation Required
Auto Configure	Advanced 8	Confirmation Required



CONFIGURING

EXAMPLE # 1: CHANGING THE SLEEP TIMER SETTING

In this example, the user wishes to change the sleep timer in one zone from the default of 5 seconds to 30 seconds.

Programming Steps	Required Action	Resulting LED Feedback
Step # 1: Enter programming mode.	Press and hold both buttons for at least 1 second.	All three LED's flash twice then strobe sequentially left to right once, then extinguish. After one second the green LED flashes once indicating that you are at function # 1.
Step # 2: Since the sleep feature is function # 1, the proper function is already selected, and only needs to be accepted.	Press the right button.	The LED's strobe sequentially left to right twice and then extinguish. After one second, the green LED flashes once to indicate setting #1 for the sleep function.
Step # 3: Select the 30 second sleep timer setting.	Press the left button 3 times to increment from setting # 1 to setting # 4.	The green LED flashes 4 times to indicate that you have selected setting # 4, the 30 second setting.
Step # 4: Accept the 30 second sleep timer setting.	Press the right button.	The LED's strobe sequentially right to left twice and then extinguish. After one second, the green LED flashes once indicating that you are back at function #1.
Step # 5: Exit programming mode.	Press and hold both buttons for at least 1 second, or do not push either button for 30 seconds.	All three LED' flash twice then strobe sequentially right to left once and then resume normal operation.



EXAMPLE # 2: SETTING ALL ZONES TO “SLUG MODE ONLY”

In this example, the user wishes to operate the entire conveyor in slug mode all of the time.

Programming Steps	Required Action	Resulting LED Feedback
Step # 1: Enter programming mode on the module in the discharge zone of the conveyor.	Press and hold both buttons for at least 1 second.	All three LED's flash twice then strobe sequentially left to right once, then extinguish. After one second the green LED flashes once indicating that you are at function # 1.
Step # 2: Select the singulate/slug mode function.	Press the left button once to increment from function # 1 to function # 2.	The green LED flashes 2 times to indicate that you have selected function # 2, the singulate/slug mode function.
Step # 3: Accept the singulate/slug mode function.	Press the right button.	The LED's strobe sequentially left to right twice and then extinguish. After one second, the green LED flashes once to indicate setting # 1 for the singulate/slug mode function.
Step # 4: Select the “slug only” setting.	Press the left button 2 times to increment from setting # 1 to setting # 3	The green LED flashes 3 times to indicate that you have selected setting # 3, the “slug only” setting.
Step # 5: Accept the “slug only” setting	Press the right button.	The LED's strobe sequentially right to left twice and then extinguish. After one second, the red LED turns on (indicating that you are in advanced programming mode) and the green LED flashes once, indicating that you are at advanced function # 1.
Step # 6: Select the advanced programming mode function.	Press the left button 7 times to increment from function # 1 to function # 8	The green LED flashes 8 times to indicate that you have selected function # 8, the advanced programming mode function.
Step # 7: Accept the advanced programming mode function.	Press the right button.	The LED's strobe sequentially right to left twice and then extinguish. After one second, the red LED turns on (indicating that you are in advanced programming mode) and the green LED flashes once, indicating that you are at advanced function # 1.
Step # 8: Select the “clone” function.	Press the left button 2 times to increment from advanced function # 1 to advanced function # 3.	The green LED flashes 3 times (with the red LED on) to indicate that you have selected advanced function # 3, the clone function.
Step # 9: Accept the “clone” function.	Press the right button.	The LED's strobe sequentially right to left once and then the yellow LED turns on, indicating that this function must be confirmed.
Step # 10: Confirm the “clone” function.	Press and hold both buttons down for greater than 1 second.	The LED's strobe sequentially right to left once then all three LED's flash until the keys are released.
Step # 11: Exit programming mode.	Press and hold both buttons for at least 1 second, or do not push either button for 30 seconds.	All three LED's flash twice then strobe sequentially right to left once and then resume normal operation.



CONFIGURING

EXAMPLE # 3: RESETTING ALL ZONES TO “ABEZ DEFAULTS”

In this example, the user wishes to reset all zones of the conveyor to standard ABEZ default settings.

Programming Steps	Required Action	Resulting LED Feedback
<p>Step # 1: Enter programming mode on the module in the discharge zone of the conveyor</p>	<p>Press and hold both buttons for at least 1 second.</p>	<p>All three LED's flash twice then strobe sequentially left to right once, then extinguish. After one second the green LED flashes once indicating that you are at function # 1.</p>
<p>Step # 2 Select the advanced programming mode function.</p>	<p>Press the left button 7 times to increment from function # 1 to function # 8.</p>	<p>The green LED flashes 8 times to indicate that you have selected function # 8, the advanced programming mode function.</p>
<p>Step # 3 Accept the advanced programming mode function.</p>	<p>Press the right button.</p>	<p>The LED's strobe sequentially right to left twice and then extinguish. After one second, the red LED turns on (indicating that you are in advanced programming mode) and the green LED flashes once, indicating that you are at advanced function # 1.</p>
<p>Step # 4 Select the “Reset # 1 (ABEZ)” function.</p>	<p>Press the left button 3 times to increment from advanced function # 1 to advanced function # 4.</p>	<p>The green LED flashes 4 times (with the red LED on) to indicate that you have selected advanced function # 4, the “Reset # 1 (ABEZ)” function.</p>
<p>Step # 5 Accept the “reset” function.</p>	<p>Press the right button.</p>	<p>The LED's strobe sequentially right to left once and then the yellow LED turns on, indicating that this function must be confirmed.</p>
<p>Step # 6 Confirm the “reset” function</p>	<p>Press and hold both buttons down for greater than 1 second.</p>	<p>The LED's strobe sequentially right to left once then all three LED's flash until the keys are released.</p>
<p>Step # 7 Exit programming mode</p>	<p>Press and hold both buttons for at least 1 second, or do not push either button for 30 seconds.</p>	<p>All three LED' flash twice then strobe sequentially right to left once and then resume normal operation.</p>



• Configuring a Zone Controller with Genesis™ Configuration Software

The PC adapter cable with Hytrol's Genesis™ configuration software provides access to the full feature set of the EZLogic® zone controller. The cable plugs to the auxiliary port of a zone controller and provides a 9-pin RS232 serial interface to a Windows PC through a built-in serial port or, by the use of a third-party adapter, through an available USB port.

Installing Genesis™ on a PC

The Genesis™ software comes packaged with the PC adapter. To install Genesis™ on your PC:

1. Insert the Genesis™ installation CD into your CD-rom drive.
2. If the Genesis™ setup program does not automatically start, use Windows explorer to navigate to your CD-rom drive and double-click "setup.exe."
3. Follow the on-screen instructions.

Connecting the PC to a Zone Controller

1. Connect the PC adapter cable to an available 9-pin serial port on the PC. If the PC does not have a serial port, a USB-to-serial adapter (supplied by others) may be used.
2. Connect the other end of the PC adapter cable to the auxiliary port of the zone controller.

Starting Genesis™

1. Make sure that the PC is connected to the zone controller and that the zone controller is powered. NOTE: the zone controller must be powered by the normal EZLogic® system power or from another 24-27 VDC power source. The zone controller is not powered by the PC adapter cable.
2. Start Genesis™ by clicking "Start—Programs—Genesis—Genesis."
3. The Genesis™ startup screen will appear, followed by the following dialog:
If you are connected to a zone controller, click "Yes".

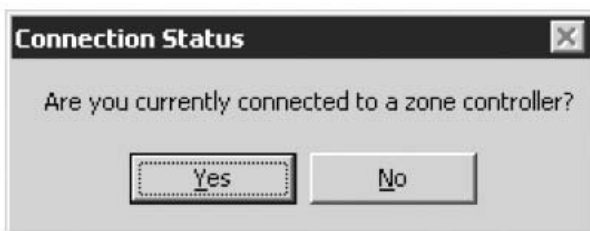

4. The Genesis™ startup screen will display while the program attempts to find the zone controller and retrieve information from it. If the connection is successful, the main program screen is displayed showing the configuration information from the controller.

If you click "No" at the "Connection Status" dialog, the following screen is displayed:

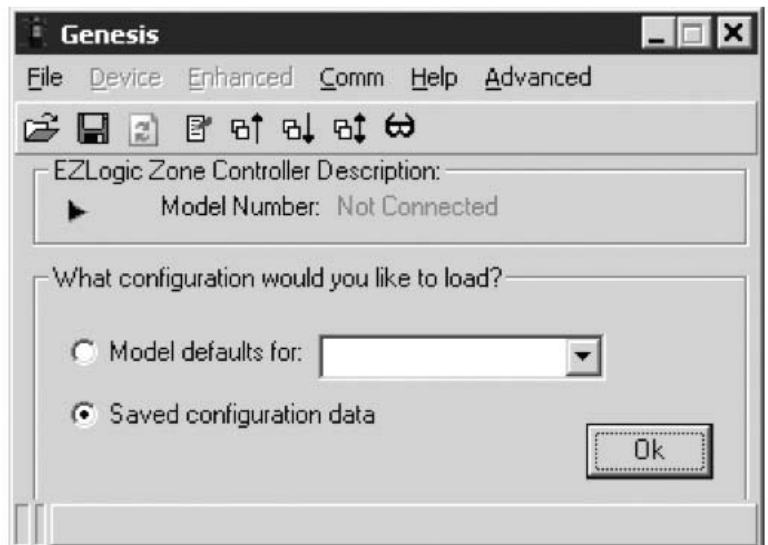

CONFIGURING

If you click “Yes” at the “Connection Status” dialog, but Genesis™ is not able to read information from the controller, the following screen is displayed:

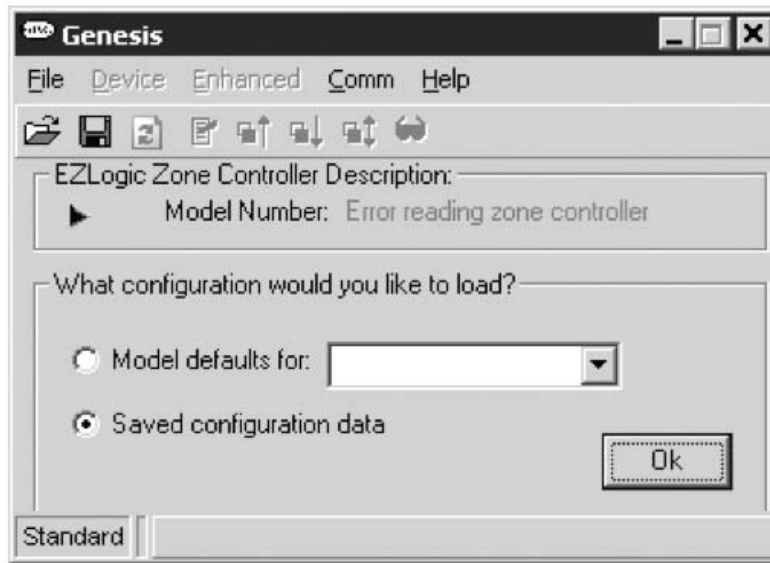

This can be caused by one of the following:

- The PC adapter cable is not connected to the computer.
- The PC adapter cable is not connected to the zone controller.
- There is no power to the zone controller.
- The zone controller is connected to a serial port or adapter assigned to a COM port (serial port) higher than COM 16.
-

Genesis™ initially tries to connect to a zone controller using the COM port set using the “File—Preferences” dialog. If no zone controller is found at the preferred port, Genesis™ checks each of the available COM ports on the PC, through COM 16, until a zone controller is found. If you connect to a zone controller after starting Genesis™, you may cause Genesis™ to repeat the port search by clicking the “refresh” button (🔄). You can also select the desired COM port manually by selecting the port from the “Comm” menu.

NOTE: You may load and view conveyor model defaults and saved configuration files even when there is no zone controller connected to the computer. These may be edited and saved as new configuration files, which may be retrieved later for use in zone controllers.

• Using Genesis™

Genesis™ provides an easy-to-use interface to configure the EZLogic® system. It uses an intuitive “wizard-based” approach to guide the user through the process using only a few mouse clicks. Genesis™ provides access to some of the more advanced features of EZLogic®. It also can retrieve diagnostic and operational status information from a zone controller.

Genesis™ allows the user to:

- Change the settings in a controller
- Save a controller configuration for later use
- Load and use default settings for various conveyor models
- Set “clone protection” to protect a controller from accidental overwriting of critical settings by cloning
- Check the operational status of a controller
- Retrieve diagnostic information from a controller

Main Screen—Display Mode

When Genesis™ is first started and connected to a zone controller, the main screen comes up in display mode. The following describes each region of the screen.

Zone Controller Description

This region normally displays the model number of the zone controller. Clicking the triangular arrow expands the region to display other information about the controller, such as the date of manufacture, controller type, etc.

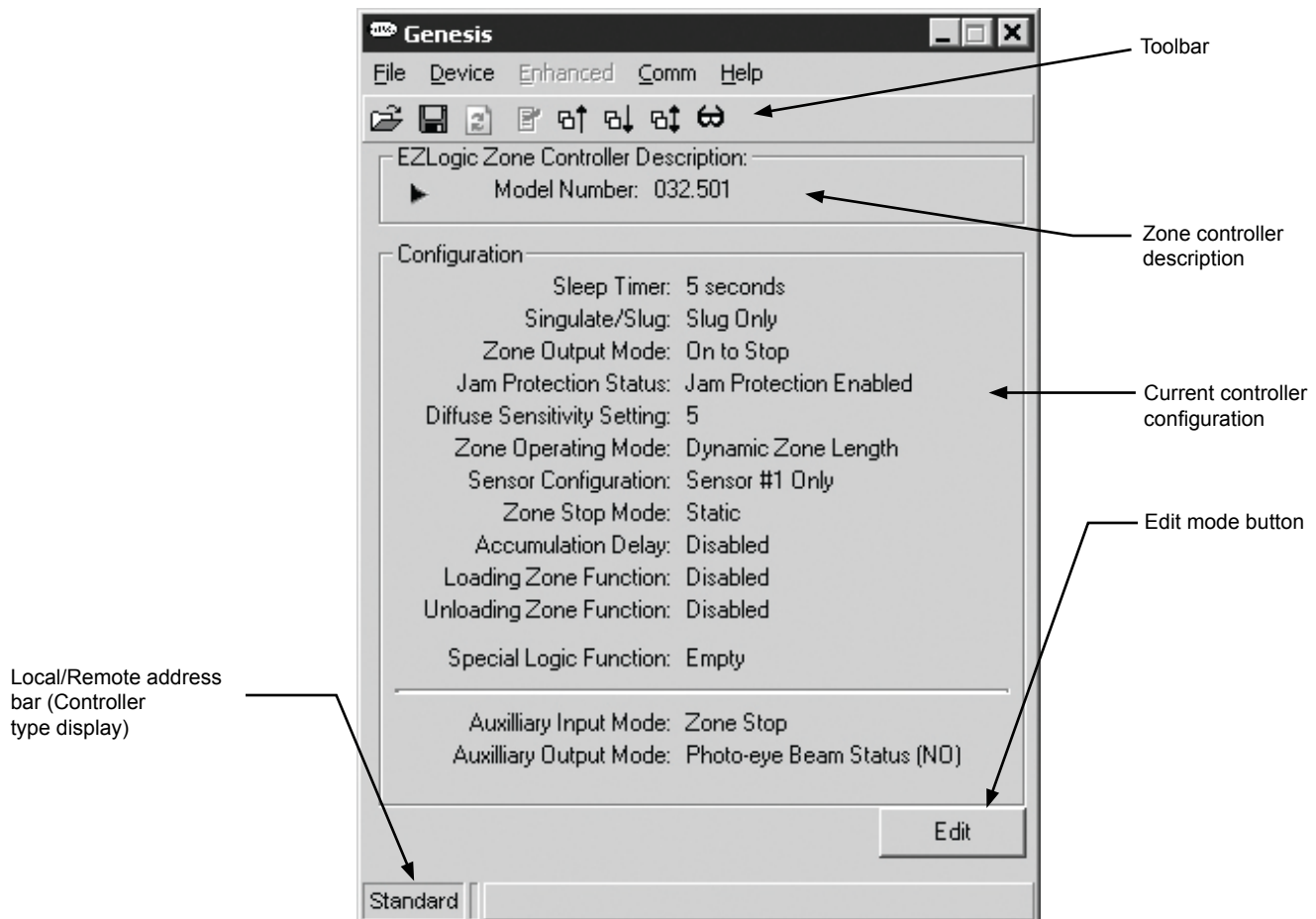

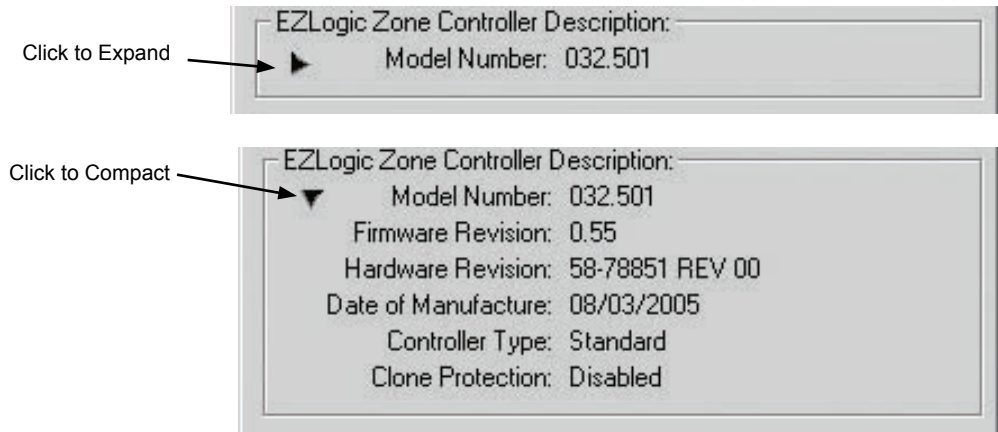









Current Controller Configuration

This region displays the current configuration of the zone controller. This information updates when a setting is changed or the “refresh” button is pressed. The configuration settings above the line are included as part of a clone command, while the settings below the line are not cloned.



Toolbar

The toolbar provides quick access to most-used commands.

-  Load a saved configuration file.
-  Save a configuration file.
-  Read/refresh settings from the controller.
-  From edit mode, write the configuration to the controller.
-  Clone current settings to all upstream controllers in the chain.
-  Clone current settings to all downstream controllers in the chain.
-  Clone current settings to all controllers in the chain, both directions.
-  Open the controller status monitor window.

Local/Remote Address Bar

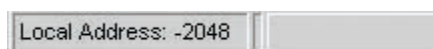
This region displays information about the local and (if present) remotely connected controller.

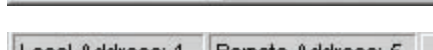
-  Standard Connected to a standard zone controller.
-  Local Address: -2048 Connected to an enhanced controller that has not been assigned an address.
-  Local Address: 1 Connected to an enhanced controller that has been addressed (address is 1).
-  Local Address: 1 Remote Address: 5 Connected to an enhanced controller locally (address 1), connected to an enhanced controller remotely (address 5).

Main Screen—Edit Mode

Clicking the Edit button on the main screen changes the screen to edit mode.

In edit mode the configuration settings are displayed in edit boxes. If the settings have not been altered from the current settings in the zone controller the values are displayed with black text. If a value has been edited, but has not yet been written to the zone controller, the value is displayed with red text to indicate that this value does not match the current setting in the controller.

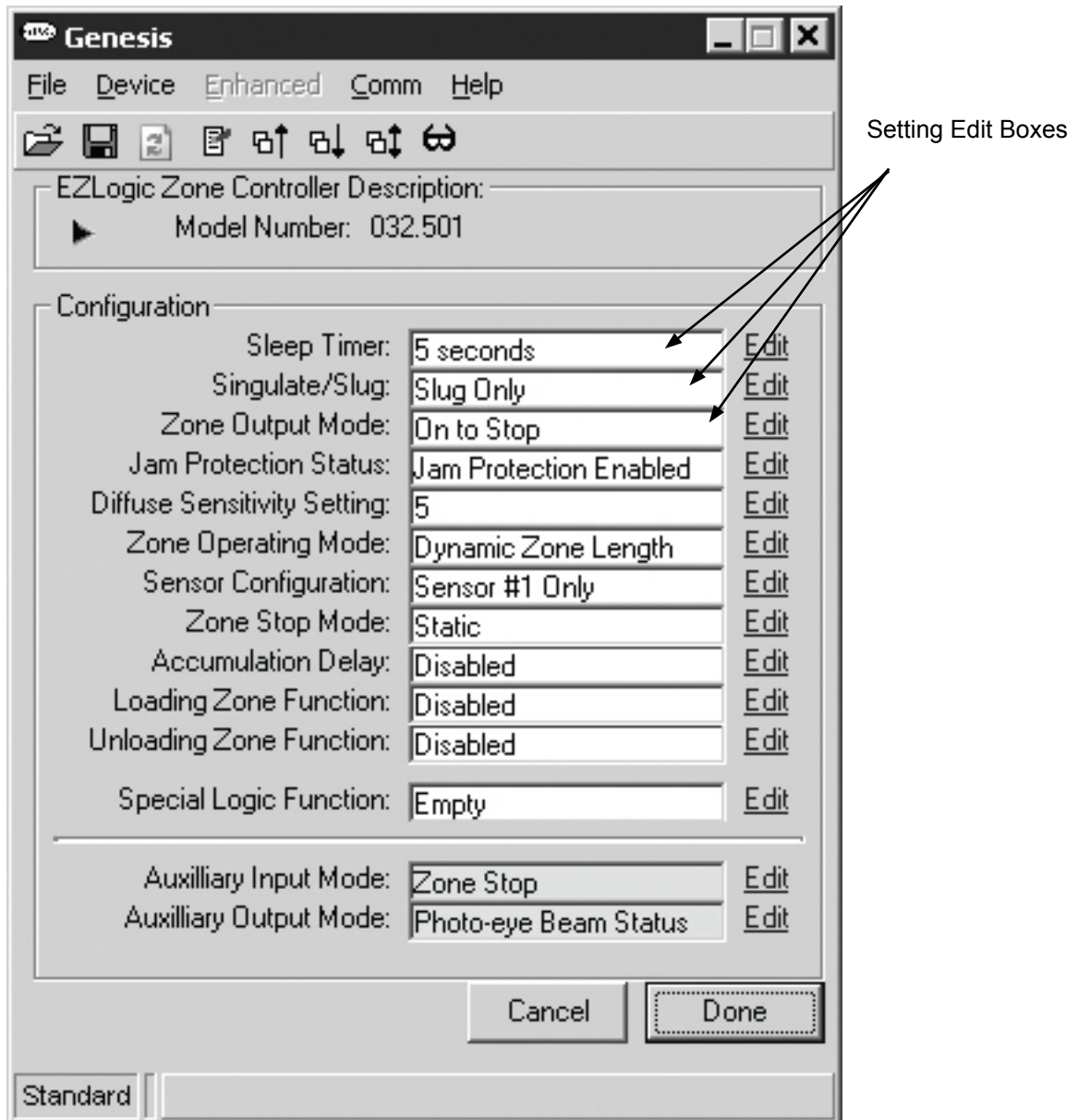

Editing a Configuration Setting

To edit a setting, do one of the following:

- Click on the word “Edit” beside the edit box.
- Double-click in the edit box.

This will bring up a configuration wizard for that function. A typical wizard screen is shown below:

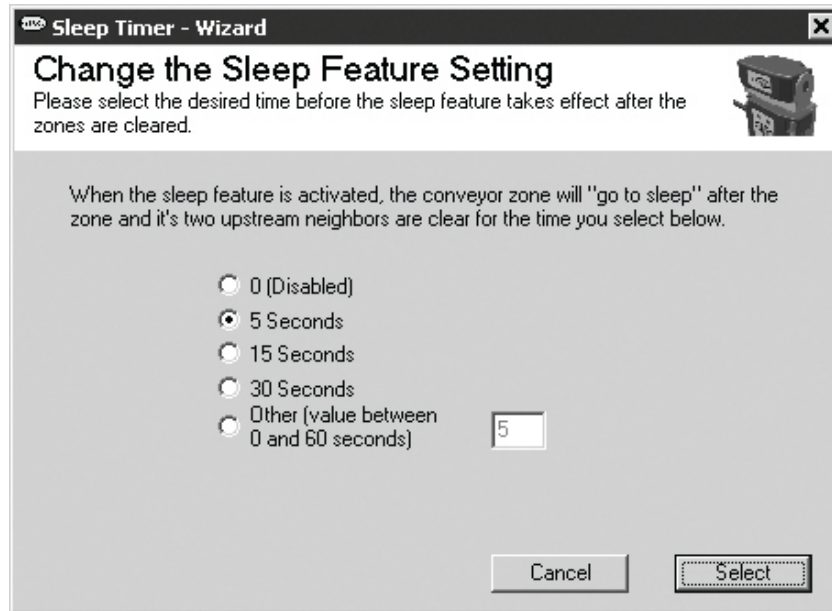

The actual appearance of the wizard screen will vary depending on the function. Each wizard includes a brief description of the function and its settings. In the example above, the wizard gives you the option of choosing a preset value or of entering an unlisted value in the box provided.

Most wizards require only one step to select a value. Some wizards, such as the Loading Zone wizard, require more information from you. These wizards may have two or more steps to perform to complete them. The wizards lead you step-by-step through the configuration process.

When the wizard is completed, it closes. The changed value is displayed on the main screen in red text. Edit other settings, if desired, by clicking the appropriate edit boxes and following the associated wizards.

Once all desired changes have been made, click the “Done” button on the main screen. The displayed settings are written to the zone controller and the main screen returns to display mode, showing the new settings in the controller.

Clicking the “Cancel” button returns the main screen to display mode without writing any of the edited values to the zone controller.

Special Logic Functions

To select and configure a special logic function, click the edit button on the main screen, then double-click the "Special Logic Function" edit box.

Special Logic Functions with Standard Zone Controllers

If you are connected to a standard zone controller, the following wizard screen appears:



If there is a special logic function already loaded into the zone controller, the name and description of the function will be displayed on this screen. To select the function you wish to load, click "Next". The following screen appears:



CONFIGURING

This screen displays a list of the special logic functions available to Genesis™ to load into a standard zone controller. Highlight the desired function and click “Select”. This will launch a wizard to allow you to configure the logic function as required. If you do not highlight a function on the list, clicking “Select” will bring up a dialog asking if you wish to remove any existing logic function from the controller. To remove the existing function, click “Yes”.

NOTE: A standard EZLogic® zone controller can only have one special logic function loaded at one time. Loading a new logic function will overwrite any existing logic function in the controller.

When the special logic wizard is completed you are returned to the main editing screen. Clicking “Done” writes the special logic function to the zone controller.

Special Logic Functions with Enhanced Zone Controllers

Enhanced zone controllers have four special function locations that allow an enhanced controller to have up to four special logic functions loaded at one time. Some special logic functions designed for enhanced zone controllers may use more than one function location in the controller.

The special logic wizard for enhanced zone controllers is slightly different from the one for standard zone controllers:

The left box on the screen displays a list of the special logic functions available to Genesis™ to load into an enhanced zone controller. The right box displays the functions, if any, which are already loaded into the zone controller. The number to the right of each function is the number of logic locations used by that function.

To add a function to the controller, highlight the function in the left box. A description of the function is displayed above the box. Click the upper arrow button. This copies the function to the right box function list. To remove a function from the right box, highlight that function and press the lower arrow button. Clearing all functions from the right box will unload all special functions from the controller.

Clicking “Next” will open the next wizard screen, which lists all functions you selected that will require additional configuration from you. Clicking “Continue” will bring up wizards that allow you to configure the special logic functions as desired.

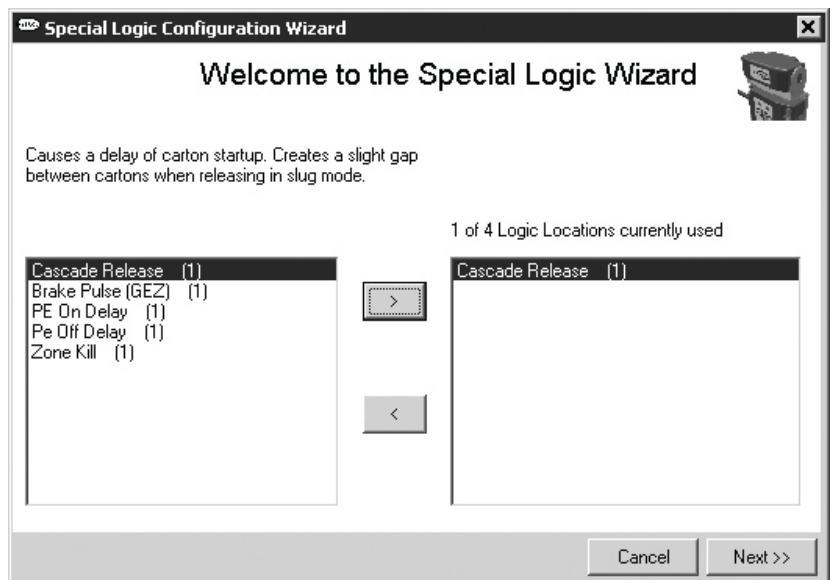
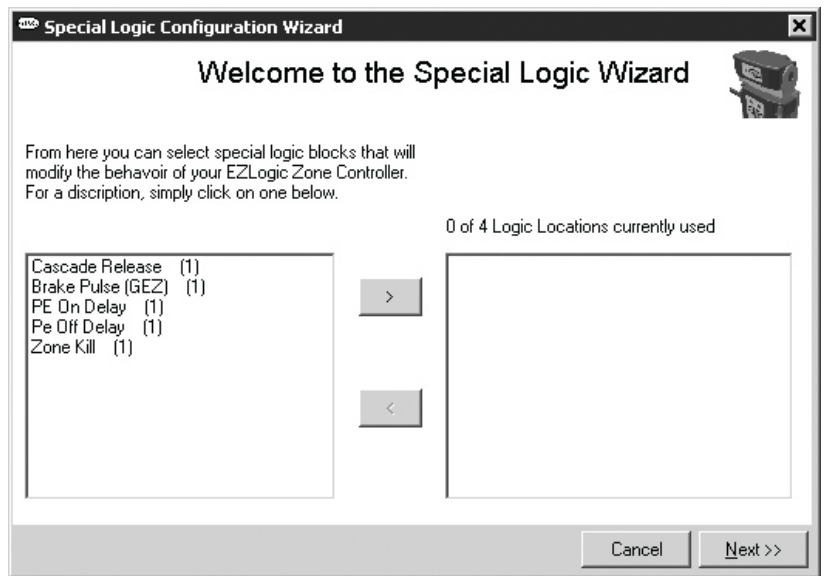



When the special logic wizards are completed you are returned to the main editing screen. Clicking “Done” writes the special logic function(s) to the zone controller.

The Menu Bar

The menu bar of Genesis™ provides access to other features of the software.

File Menu

The file menu includes the following choices:

Preferences

The preferences option allows you to configure the default behavior of Genesis™ to suit your needs. When selected, the following dialog appears:

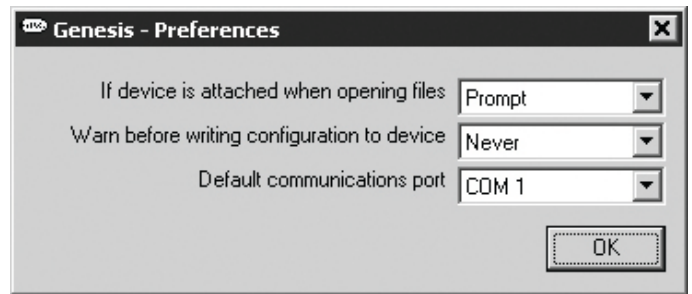

Here you may choose whether Genesis™ prompts you before writing to a zone controller or when opening configuration files. You may also choose the default communications port that Genesis™ will attempt to use first when started.

Load Model Defaults

This options allow you to select from a list of Hytrol conveyor models equipped with EZLogic®.

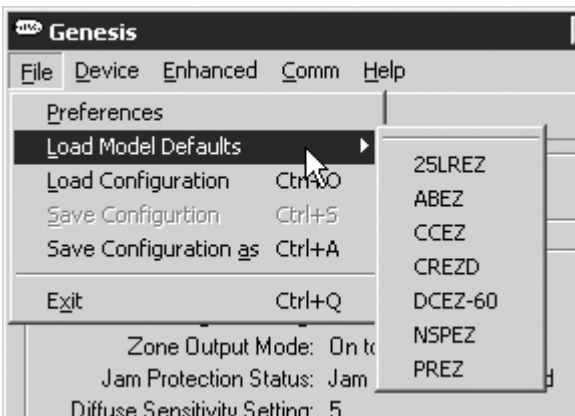

When you select a conveyor model a default configuration for the conveyor model is loaded. In preferences, if the “If device is attached when opening files” is set to “Prompt” the following dialog appears:

Clicking “Overwrite” will immediately write the defaults to the zone controller. Clicking “Preview” will expand the main screen to show the model defaults next to the current zone controller settings. Any settings that are different will be highlighted with red text in the model defaults display.

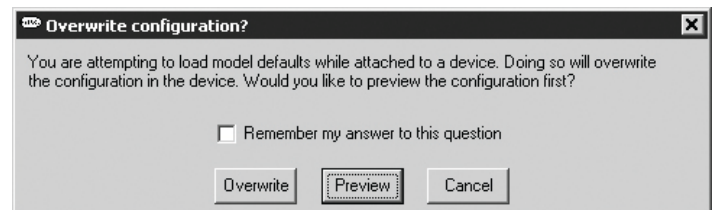

CONFIGURING

Clicking the long vertical button in the center of the screen will write the model defaults to the zone controller. Clicking "Cancel" will return the main screen to normal display mode.

Load Configuration

"Load configuration" allows you to open up a saved configuration file. Configuration files have a ".ezl" extension. Configuration files may be written directly to the zone controller or previewed, similar to model defaults.

Save Configuration, Save Configuration As...

"Save configuration" allows you to save the configuration displayed on the screen to a configuration file. It brings up a save file dialog box. You may save the file to the location of your choice on your computer.

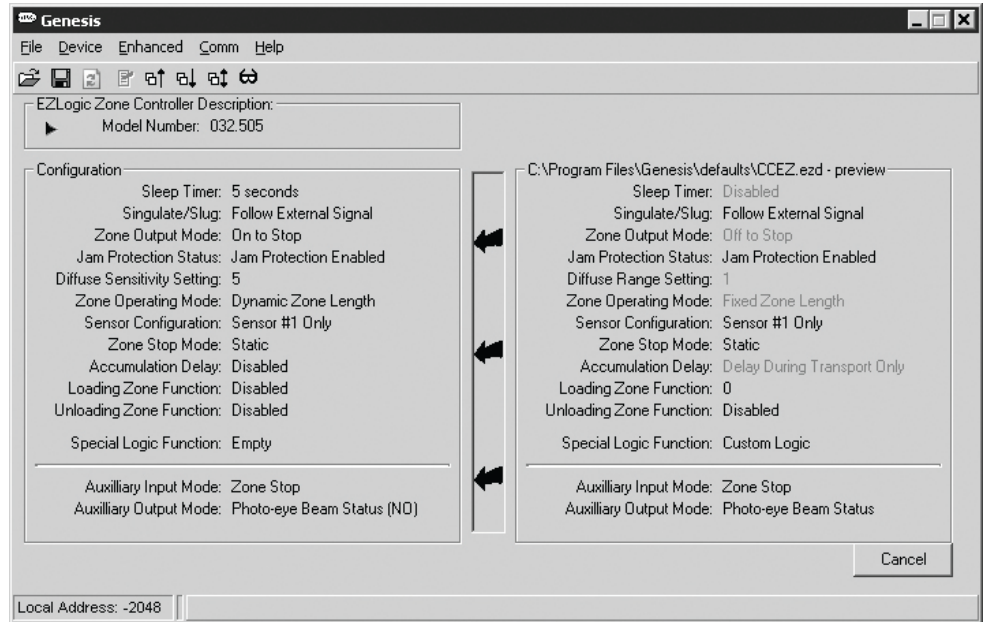

Device Menu

The device menu contains items related directly to the zone controller.

About Device

This selection brings up a dialog that lists physical information about the zone controller. Most of the information is the same as that found in the expanded zone controller description region of the main screen.

Clone

This selection brings up a submenu with the following choices:

- Clone Upstream
- Clone Downstream
- Clone Both Directions

These choices are also available on the toolbar.

Enable (Disable) Clone Protection

This menu option toggles between enabling and disabling the clone protection feature of the zone controller. When clone protection is enabled in the controller a check mark is displayed to the left of this item in the menu.



When clone protection is enabled a zone controller cannot be changed by a clone command sent by another zone controller. This prevents critical settings in a zone controller from being accidentally changed. The zone controller will pass the clone command on to the other controllers in the chain.

The zone controller may still be configured directly.

Auto Configure

Auto Configure is a very useful function when there is a need to replace an EZLogic® zone controller. When this function is selected the zone controller retrieves the configuration of one of the two adjacent zone controllers. This configuration is then applied to the zone controller. This provides an easy way to configure a replacement zone controller for your particular application.

Diagnostic Information

This menu option brings up the diagnostic information screen.

This screen shows information about the zone controller, such as the number of zone actuations, time since the last communications error, etc. This information may be used to help troubleshoot problems with a zone controller.

The **Save** button brings up a save dialog that allows you to save a text file to your computer. This file includes the zone controller description, the configuration of the zone controller, and the diagnostic information on the screen.

The **Read/Refresh** button refreshes the diagnostic screen with data from the zone controller.

The **Reset** button will reset all of the diagnostic information in the zone controller except the "Time 'powered up' (lifetime)" and "Number of zone actuations".

The **Close** button closes the diagnostics screen.

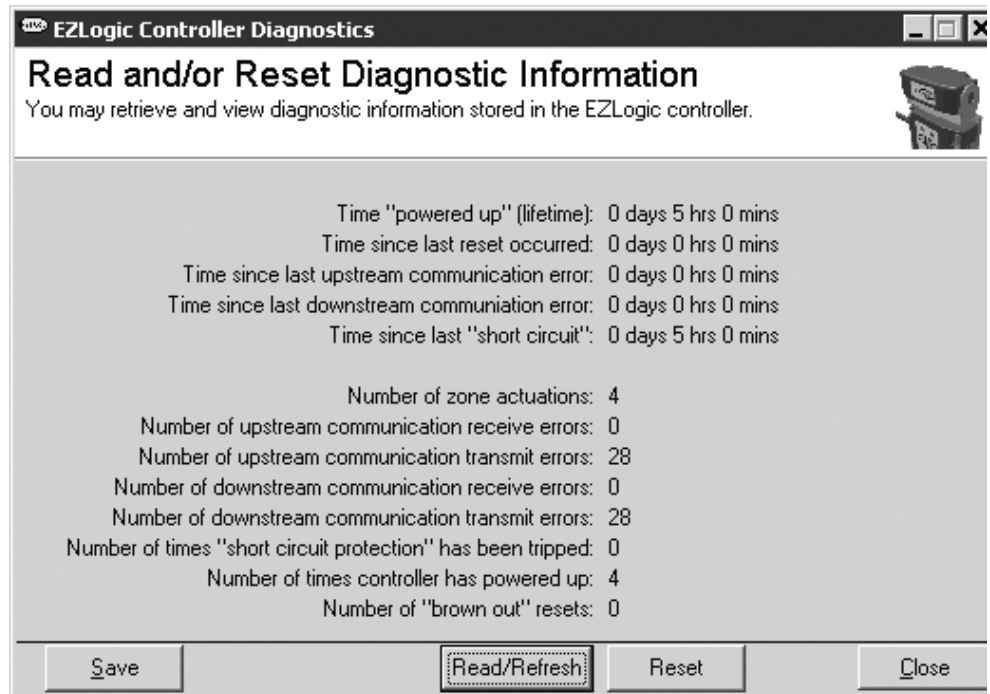

Reset Diagnostics

This options brings up a submenu that allows you to choose:

- Reset upstream
- Reset downstream
- Reset both directions

These commands reset the diagnostics information of the zone controller AND ALL ZONE CONTROLLERS IN THE DIRECTION CHOSEN. The exceptions are the "Time 'powered up' (lifetime)" and "Number of zone actuations" values.



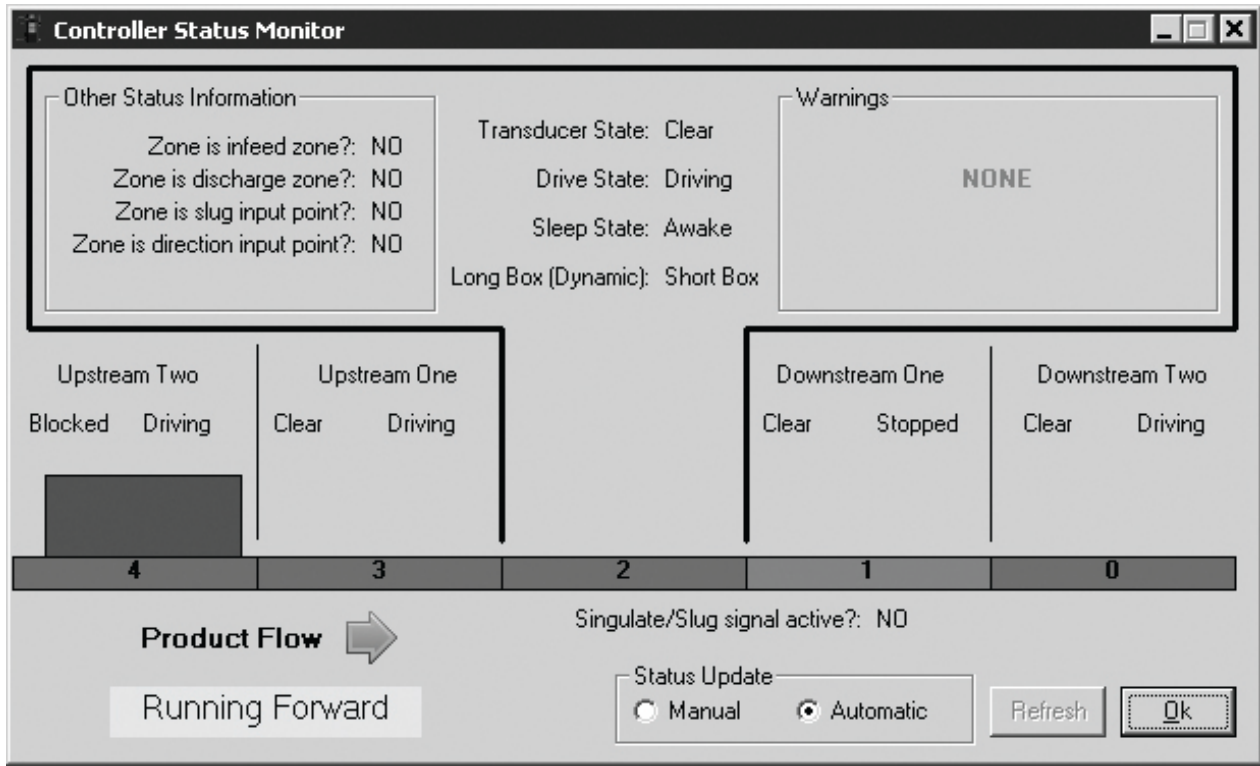

Status Monitor

This command (also on the toolbar) brings up the “Status monitor” screen:

The status monitor screen shows a snapshot of the zone controller’s status. The green and/or red areas represent conveyor zones. The center “zone” represents the zone where the currently connected zone controller is installed. The other zones represent the two zones on each side of the connected zone controller.

A “zone” that is red represents a zone that is stopped. A “zone” that is green represents a zone that is driving. The direction of conveyor flow is “left-to-right”. The brown rectangles represent cartons occupying the zone in that location.

Other important status information is displayed when needed. This information includes:

- Drive output shorted/open
- Jam detected
- Low voltage detected
- Zone is infeed, discharge, a slug input point, etc.
- Current direction of flow, singulate/slug status

When connected locally, the “Automatic” option may be selected. This causes the status monitor to be updated at regular intervals. A “near real-time” view of carton movement in the five-zone “window” can be achieved in this manner. NOTE: The “Automatic” option is not available when connected to a zone controller remotely.

Enhanced Menu

This menu is only available when connected to an enhanced zone controller.

IOP Configuration

This menu option brings up the IOP configuration screen:

The IOP configuration screen is used to set up a zone controller to use the IOP system for control wiring. This screen is described in the “EZLogic® IOP Solutions” manual.

Initialize Addressing

This system-wide command assigns an address to every zone controller in the chain. It may be invoked from any enhanced controller in the chain. The zone controller at the discharge end of the chain is assigned address “1”. All controllers in the upstream direction are given a number in sequence, with the last controller on the infeed end receiving the “largest” address.

NOTE: Initializing addressing may take several minutes to complete!

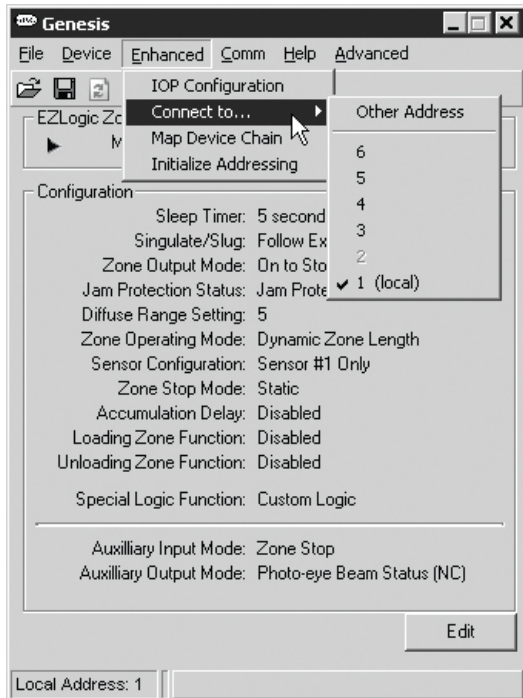
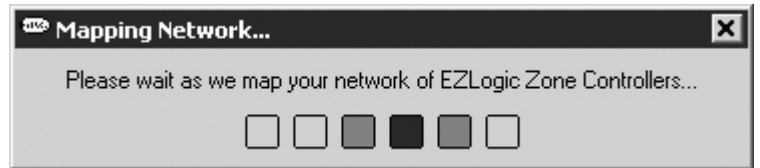
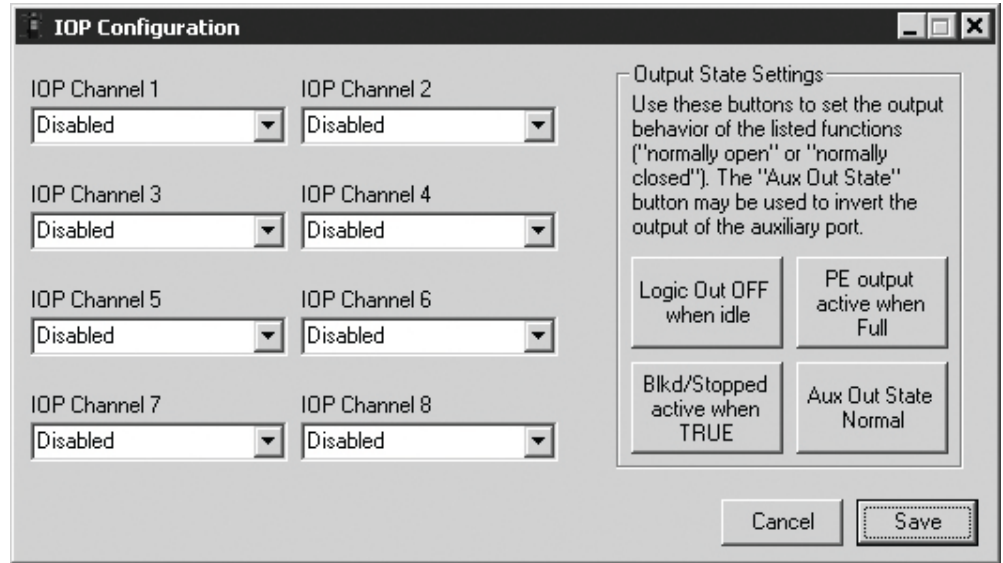

Map Device Chain

This command polls each zone controller and “populates” the “Connect to...” submenu with a list of all controllers in the chain.

NOTE: Mapping the device chain may take several minutes!

While Genesis™ is mapping the device chain the above message is displayed:

Connect to...

This option brings up a submenu. If the zone controller chain has been addressed and mapped, the submenu will be “populated” with a list of all zone controllers in the chain.

Enhanced zone controllers are displayed in the list in normal type, while standard controllers are “grayed out”. Enhanced controllers may be connected remotely by clicking the address of the controller on the list. The currently “active” zone controller will have a checkmark displayed to the left of its address in the menu. The zone controller that is directly connected to the computer is labeled “local” in the list.



CONFIGURING

Standard controllers may not be configured remotely. However, a snapshot of the status of a standard controller may be retrieved by clicking “Other Address” at the top of the submenu and manually entering the standard controller’s address.

Comm Menu

The comm menu lists the available serial ports on the computer. A different serial port may be selected by clicking on that choice in the menu.

More About Remote Connection and Addressing

An enhanced controller may be accessed remotely by Genesis™ by clicking or entering its address. When Genesis™ is connected to a remote controller, the local address and the remote address are displayed in the address bar at the bottom of the screen, and the description, configuration, and diagnostic information displayed are from the remote address.

Using remote connection and addressing with enhanced controllers, you may:

- Configure all settings
- Retrieve diagnostic information
- Retrieve a snapshot of the zone controller’s status using the status monitor

You may not:

- Perform any “real-time” inputs or outputs
- Use the status monitor for “near real-time” automatic monitoring
- Configure settings or retrieve diagnostic information from a standard zone controller
- Monitor the “real time” status of all zone controllers in the chain

NOTE: communicating with a zone controller remotely is rather slow. It may take several seconds for a command, configuration change, or update request to reach or return from a remote zone controller.



SPECIFICATIONS

• EZLogic® ZONE CONTROLLERS AND ACCESSORIES

ZONE CONTROLLERS/TRANSDUCERS

UNITIZED ZONE CONTROLLER – RETRO-REFLECTIVE TYPE

P/N 032.501

Includes mounting base.

Optical range:

72" to 2" reflector, 108" to 3" reflector

Power input specifications:

Regulated 27VDC power supply (Hytrol IOP) required.

Maximum of 25 zones either side of IOP T cable, 50 zones total.

NOTE: Zone controller will indicate low voltage if input voltage is 20 VDC or less.

WARNING! A short-circuit protected power supply must be used. Hytrol strongly recommends that ONLY a Hytrol supplied power supply (or IOP) be used.

Power output specifications:

27VDC, 100mA maximum output per zone controller.

Current sinking output.

Short-circuit, overload, and reverse polarity protected.

Control inputs:

Auxiliary Input:

Logic level input, may be connected to any zone.

Connect to dry-contact type device ONLY.

Less than 1mA current flow through contact, 27VDC.

Environmental specifications:

Enclosure rating:

UL Type 1, 2 (with push-on cordsets); 1, 2, 4, 4X (with screw-on cordsets)

Operating Temperature: -13 to 131° F.

Humidity: 0 to 90% Non-condensing.

Approvals: UL 508 and CSA 22.2 NO. 14

UNITIZED ZONE CONTROLLER–DIFFUSE TYPE, STD CABLE

P/N 032.502

Specifications are the same as 032.501 except as listed below.

Optical Range:

48" maximum to 90% reflectance target without obstruction.

Sensitivity is adjustable through programming.

UNITIZED ZONE CONTROLLER–DIFFUSE, 24 IN. LG. CBL

P/N 032.503

Specifications are the same as 032.502 above except w/24 in. transducer cable.

REMOTE ZONE CONTROLLER

P/N 032.504

Specifications are the same as 032.501 except optical.

ENHANCED RETRO-REFLECTIVE ZONE CONTROLLER

P/N 032.505

Specifications are the same as 032.501.

ENHANCED DIFFUSE ZONE CONTROLLER

P/N 032.506

Specifications are the same as 032.502.

ENHANCED REMOTE ZONE CONTROLLER

P/N 032.507

Specifications are the same as 032.504.



REMOTE RETRO-REFLECTIVE TRANSDUCER

P/N 032.511

Optical range: 72" to 2" reflector, 108" to 3" reflector

REMOTE DIFFUSE TRANSDUCER, STANDARD

P/N 032.512

Optical Range: 48" maximum to 90% reflectance target without obstruction.

Sensitivity is adjustable through programming.

REMOTE DIFFUSE TRANSDUCER, NARROW BEAM

P/N 032.513

For looking through narrow spaces between rollers.

Optical Range: 10" nominal to 90% reflectance target.

Sensitivity is not adjustable.

REMOTE RETRO-REFLECTIVE TRANSDUCER (FOR DUAL)

P/N 032.514

Optical range: 72" to 2" reflector, 108" to 3" reflector

Recognized by remote zone controller as sensor #2.

REMOTE DIFFUSE TRANSDUCER (FOR DUAL)

P/N 032.515

Optical Range: 48" maximum to 90% reflectance target without obstruction.

Sensitivity is adjustable through programming.

Recognized by remote zone controller as sensor #2.

REMOTE DIFFUSE TRANSDUCER (NARROW BM, FOR DUAL)

P/N 032.516

For looking through narrow spaces between rollers.

Optical Range: 10" nominal to 90% reflectance target.

Sensitivity is not adjustable.

Recognized by remote zone controller as sensor #2.

MOUNTING BASE

P/N 032.517

Replacement only. Supplied with all zone controllers.

RETAINING CLIP

P/N 032.521

Replacement only. Supplied with all zone controllers.

CORDSETS

INFEED ZONE TERMINATOR

P/N 032.550

Takes place of cordset at infeed end of zone controller chain.

PUSH-ON

ZONE CONTROLLER CORDSET – 12 IN. LONG

P/N 032.551

ZONE CONTROLLER CORDSET – 18 IN. LONG

P/N 032.552

ZONE CONTROLLER CORDSET – 24 IN. LONG

P/N 032.553

ZONE CONTROLLER CORDSET – 30 IN. LONG

P/N 032.554

ZONE CONTROLLER CORDSET – 36 IN. LONG

P/N 032.555

ZONE CONTROLLER CORDSET – 48 IN. LONG

P/N 032.556

ZONE CONTROLLER CORDSET – 60 IN. LONG

P/N 032.557

ZONE CONTROLLER CORDSET – 72 IN. LONG

P/N 032.558



SPECIFICATIONS

SCREW-ON

ZONE CONTROLLER CORDSET – 12 IN. LONG	P/N 032.5515
ZONE CONTROLLER CORDSET – 18 IN. LONG	P/N 032.5525
ZONE CONTROLLER CORDSET – 24 IN. LONG	P/N 032.5535
ZONE CONTROLLER CORDSET – 30 IN. LONG	P/N 032.5545
ZONE CONTROLLER CORDSET – 36 IN. LONG	P/N 032.5555
ZONE CONTROLLER CORDSET – 48 IN. LONG	P/N 032.5565
ZONE CONTROLLER CORDSET – 60 IN. LONG	P/N 032.5575
ZONE CONTROLLER CORDSET – 72 IN. LONG	P/N 032.5585

CABLES, POWER AND LOGIC

PUSH-ON

IOP T CABLE	P/N 032.559
Special "T" cable with 1 meter cable from conveyor to IOP.	
POWER AND LOGIC EXTENSION CABLE – 3 FT. LONG	P/N 032.560
POWER AND LOGIC EXTENSION CABLE – 10 FT. LONG	P/N 032.561
POWER ISOLATION CABLE	P/N 032.562
Special cable used when conveyors are located end to end using I/O from only 1 IOP. Connects the zone-to-zone and I/O communication while separating the power.	
IOP ISOLATION CABLE	P/N 032.570
Special cable used when conveyors are located end to end using I/O from more than 1 IOP. Connects the zone to zone communication while separating the power and I/O.	

SCREW-ON

IOP T CABLE	P/N 032.5595
Special "T" cable with 1 meter cable from conveyor to IOP.	
POWER AND LOGIC EXTENSION CABLE – 3 FT. LONG	P/N 032.5605
POWER AND LOGIC EXTENSION CABLE – 10 FT. LONG	P/N 032.5615
POWER ISOLATION CABLE	P/N 032.5625
Special cable used when conveyors are located end to end using I/O from only 1 IOP. Connects the zone-to-zone and I/O communication while separating the power.	
IOP ISOLATION CABLE	P/N 032.5705
Special cable used when conveyors are located end to end using I/O from more than 1 IOP. Connects the zone to zone communication while separating the power and I/O.	
POWER SPLITTER	P/N 032.569
Special cable used when conveyors are located side by side sharing power, but not I/O, from 1 IOP.	

CABLES, OTHER

NANO EXTENSION CABLE – 1 FT. LONG	P/N 032.565
Extends Auxiliary Cables and Remote Transducer Cable.	
NANO EXTENSION CABLE – 2 FT. LONG	P/N 032.566
Extends Auxiliary Cables and Remote Transducer Cable.	
NANO EXTENSION CABLE – 3 FT. LONG	P/N 032.567
Extends Auxiliary Cables and Remote Transducer Cable.	



NANO EXTENSION CABLE – 6 FT. LONG

P/N 032.568

Extends Auxiliary Cables and Remote Transducer Cable.

UPSTREAM CONNECTOR COVER

P/N 032.010

Threaded plug used to seal the unused micro connector on the upstream-most cordset when the infeed zone terminator (032.550) is not used.

DOWNSTREAM CONNECTOR COVER

P/N 032.011

Cap used to seal the unused micro connector on the downstream-most cordset.

AUXILIARY COMPONENTS

ZONE ACTUATION MODULE (ZAM)

P/N 032.531

Provides alternate drive outputs to operate various zone actuation devices.

Supply voltage: Brown wire, 27VDC Positive, 80mA Maximum
Blue wire, Negative (GND)

Contact Output: Violet and Orange wires
27VDC, 80mA Maximum

Fault input: White and Gray wires
Accepts Contact Closure Input, 27VDC, 11mA Max.

AUXILIARY I/O MODULE

P/N 032.532

Standard (dry contact) auxiliary input (brown and blue wires):

- Logic level input.
- Connect to dry-contact type device ONLY.
- Less than 1mA current flow through contact, 27v DC.

Isolated (voltage type) auxiliary input (white and gray wires):

- Zone stop on: 18-30v DC @ 5mA Min
- Zone stop off: 0-10v DC @ 1mA Max
- Input is non-polarized

Auxiliary output (orange and violet wires):

- Solid-state relay output (contact closure)
- Output is non-polarized.
- Output state determined by zone controller configuration
- Maximum acceptable current: 80mA @ 30v DC

AUXILIARY INPUT CABLE – 3 FT. LONG

P/N 032.563

Accepts contact-type signal as input to zone controller.

AUXILIARY INPUT CABLE – 10 FT. LONG

P/N 032.564

Accepts contact-type signal as input to zone controller.

AUXILIARY PHOTO-EYE RETRO-REFLECTIVE (WAKE-UP EYE)

P/N 032.591

AUXILIARY PHOTO-EYE DIFFUSE (WAKE-UP EYE)

P/N 032.592

CONFIGURATION COMPONENTS

PUSH BUTTON PROGRAMMER

P/N 032.535

Hand held programming device.

PC ADAPTOR WITH GENESIS™ SOFTWARE

P/N 032.5345

PC adaptor cable and software for programming of zone controllers.



SPECIFICATIONS

IOP UNIT AND COMPONENTS

IOP UNIT

P/N 032.582

Ref	Consideration	Specification
01	Input Voltage	130VAC or 210 – 250VAC 50/60 Hz, single phase
02	Input Current	2A at 115VAC, nominal maximum
03	Efficiency	75% typical
04	Output Power	100W Class 2
05	Output Voltage	27 ±0.5 VDC @ 60% Load
06	Output Protection	Short Circuit Protection: Foldback Current Limiting Auto-Recovery Overvoltage Protection: latching, cycle power to reset
07	Load Regulation	±3% from 20-100% Rated Load
08	Line Regulation	±1% at Rated Load for every 10% change in Input Voltage
09	Hold Up Time	20ms
10	Indicators	AC In: Red LED DC Out: Green LED LEDs located on power supply housing (Note 2)
11	DC Fail Indication Output	N/O Contact, Solid State Relay Open: DC Fail Closed: DC Good
12	Temperature Range (Store, Operate)	40 to +70 °C / -25 to +55 °C
13	Altitude	100 to 12,000 ft
14	Humidity	90% Noncondensing
15	Radiated Field Immunity	10 V/M from 20 to 1000 kHz
16	Approvals	UL1310 Class 2 output
17	Enclosure	Extruded aluminum, No potting used Internal guide slots for PCB mounting UL Type 4X
18	Ground Jumper	Required for DC Common to Chassis Ground connection (Note 1)
19	Connectors	Pluggable Connectors for power in and power out. Screw terminal connectors for I/O functions.
20	IOP Jumper	Enable / Disable IOP Signal Output (Note 3)

Note 1: A removable jumper to connect DC Common to Chassis Ground is accessible inside one of the endplate covers of the enclosure.

Note 2: The extruded aluminum housing is tapped with holes to allow indicator LEDs to shine through via light pipes. A label is used to cover and seal around the AC and DC indicator LEDs

Note 3: The IOP Jumper can be removed to disconnect the IOP signal from the output connector.



I/O BOARD FOR IOP

P/N 032.583

Installs into IOP unit to provide I/O points
4-position terminal block provides two inputs/outputs per board
Input/output configuration is set by selector switch, one per "channel"

INPUTS:

115VAC/24VDC

Off State: <18VAC/16VDC, <5mA

On State current: 40mA Maximum @ 115VAC

OUTPUTS:

Contact closure, 115VAC/24VDC, 80mA Maximum



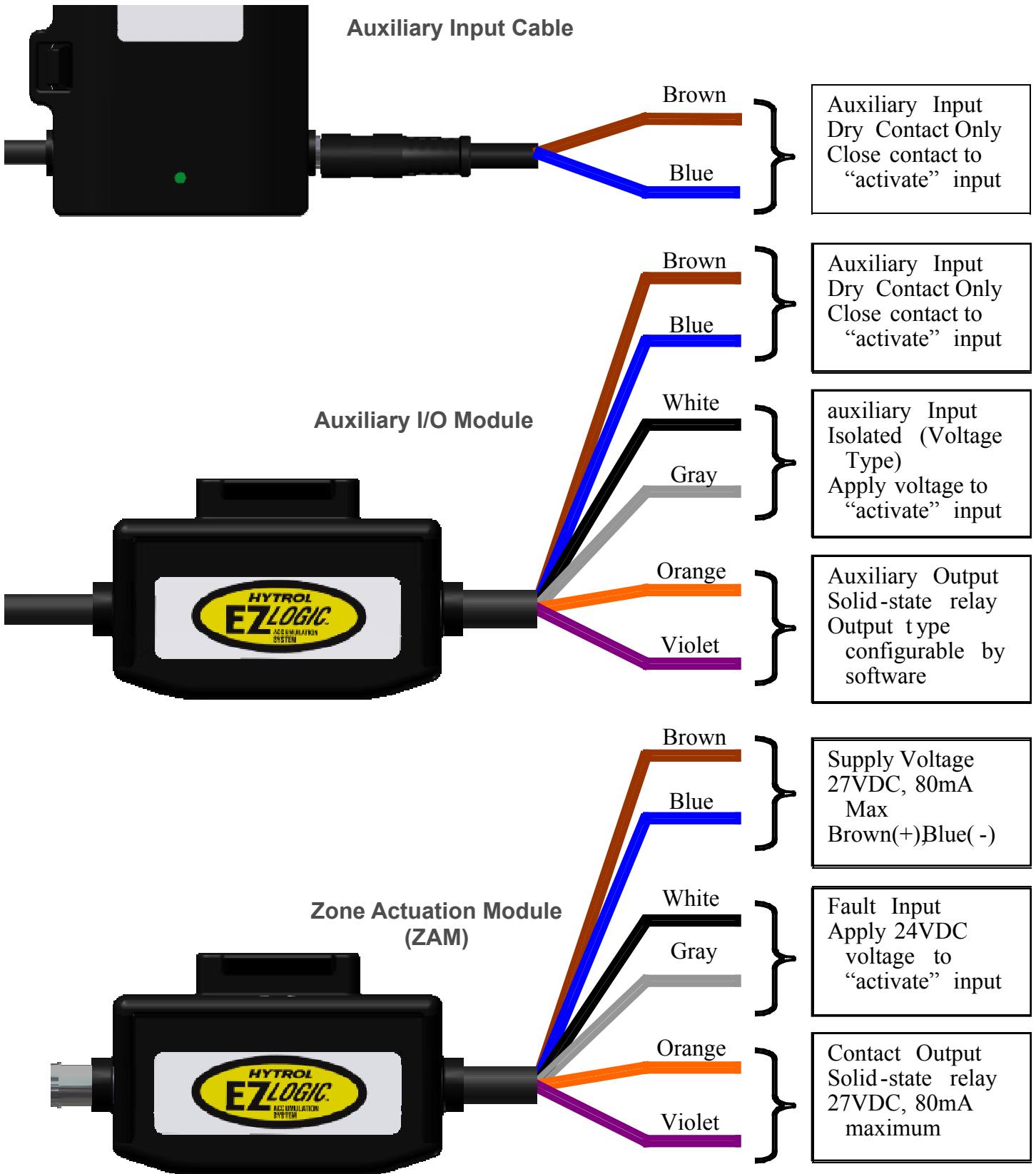

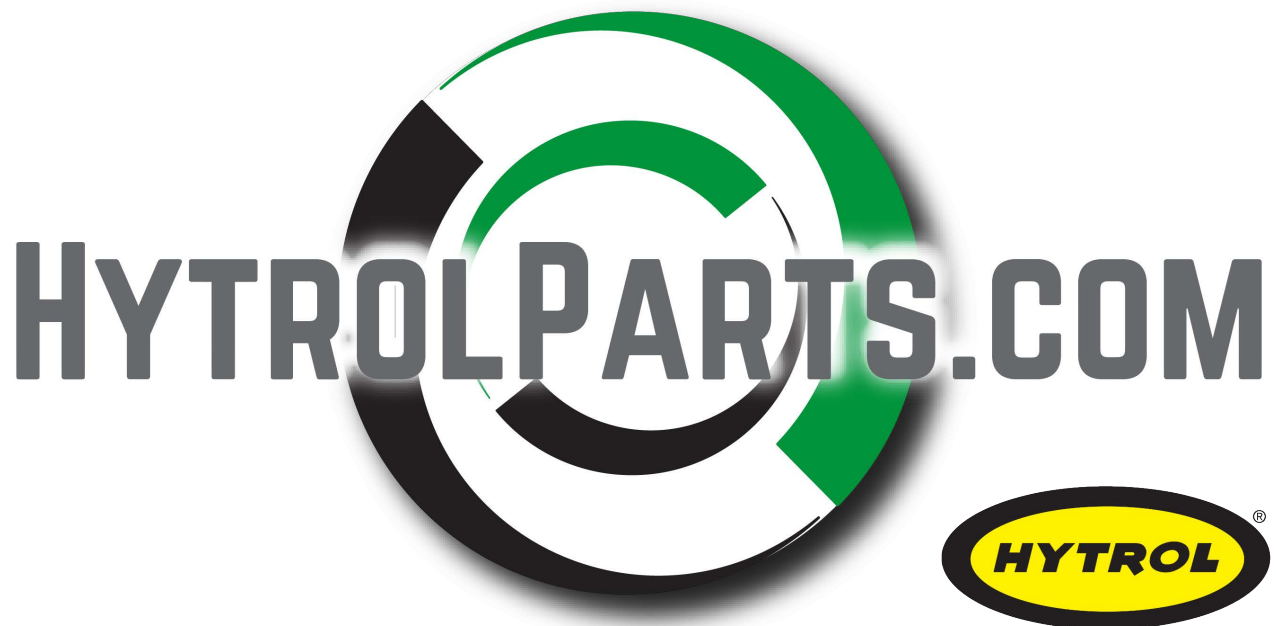

POWERED BY
CONVEYOR SOLUTIONS

"Building Relationships One Conveyor Part at a Time"

support@hytrolparts.com | www.HytrolParts.com

Use code **HYPMANUAL** for free shipping
your first order at HytrolParts.com