

Owners Manual

TropoAir

Corsica

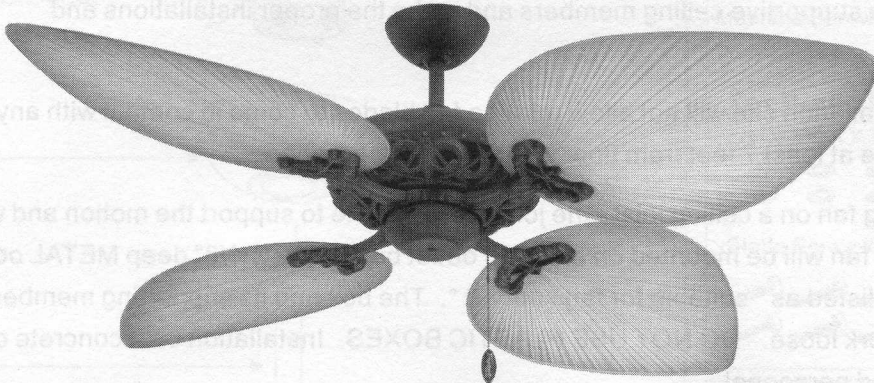

4TB53



4TB54

This instruction contains 6 pages:

Page 1: Foreword

Page 2: Unpack and inspect parts contained

Page 3: Notes before installation and Hanging system installation

Page 4: Wire connection and Canopy installation

Page 5: Blade installation

Page 6: Pull Chain knob installation



size	Net weight
53"	9.8 KGS. / 21.6 LBS.
54"	10.7 KGS. / 23.5 LBS.

READ AND SAVE THESE INSTRUCTIONS

WARNING : TO REDUCE THE RISK OF FIRE, ELECTRICAL SHOCK, OR INJURY TO PERSONS, PLEASE OBSERVE THE FOLLOWING :

- 1]. To ensure the success of the installation, be sure to read the instructions and review the diagrams thoroughly before beginning.
- 2]. **To avoid possible electric shock, be sure electricity is turned off at the main power box before wiring.**
All electrical connections must be made in accordance with local codes, ordinances and/or the National Electric Code. If you are unfamiliar with the methods of installing electrical wiring and products, require the services of a qualified and licensed electrician as well as someone who can check the strength of the supportive ceiling members and make the proper installations and connections.
- 3]. Make sure that your installation site will not allow rotating fan blades to come in contact with any object. Blades should be at least 7 feet from floor when fan is in operation.
- 4]. If possible, mount ceiling fan on a ceiling joist - the joist must be able to support the motion and weight of the moving fan. If the fan will be mounted on a ceiling outlet box, a 4" x 2-1/8" deep METAL octagon box is required ; one UL listed as " suitable for fan support ". The box and its supporting members must not be able to twist or work loose. **DO NOT USE PLASTIC BOXES.** Installation on a concrete ceiling should be performed by qualified personnel.
- 5]. Blades should be attached after motor housing is hung and in place. Fan motor housing should be kept in carton until ready to be installed to protect its finish. If you are installing more than one ceiling fan, make sure that you do not mix fan blade sets.
- 6]. After making electrical connections, spliced conductors should be turned upward and pushed carefully up into outlet box. The wires should be spread apart with the grounded conductor and the equipment - grounding conductor on one side of the outlet box and the " HOT " wires on the other side.
- 7]. Electrical diagrams are for reference only. Light kits that are not packed with the fan must be UL/ETL listed and should be installed per the light kit's installation instructions.
- 8]. After fan is completely installed, check to make sure that all connections are secure to prevent fan from falling and/or causing damage or injury.
- 9]. The fan can be made to work immediately after installation. The bearings are adequately charged with grease, so that under normal conditions, further lubrication should not be necessary.
- 10]. The fan must be turned off and stopped before reversing fan direction.
- 11]. **The fan is for suitable for slope ceiling.**
- 12]. **This fan is reversible.**
- 13]. **This fan is light kit adaptable.**
- 14]. **This fan is remote adaptable.**
- 15]. **This fan is suitable for damp location use.**

Net weight	Size
9.9 KGS / 21.8 LBS	30"
10.7 KGS / 23.5 LBS	34"



Unpack and inspect fan carefully to be certain all contents are included.

Note:

This fan is designed for the following 2 sizes of blades, packed in a separate box.

* 53" Palm Leaf Resin Blades (4 pcs)

* 54" Large Oval Distressed Walnut Wood Blades (4 pcs)

Make sure you have received two boxes, one for fan and one for blades.

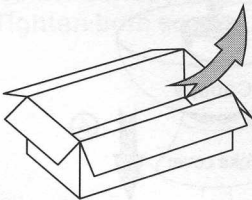
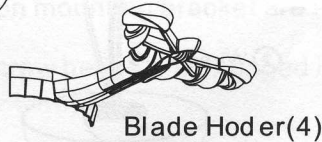
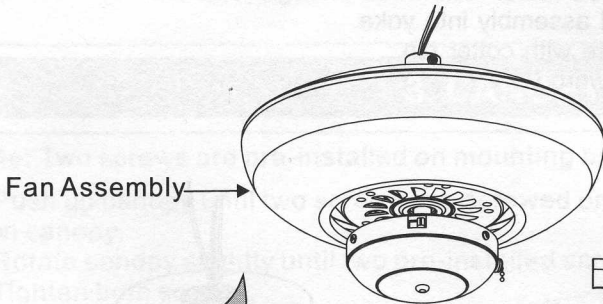
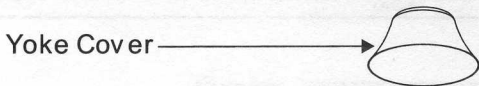
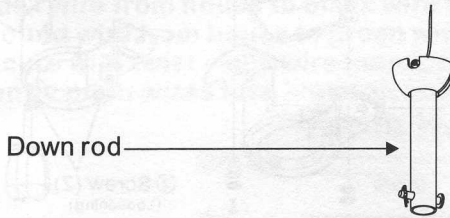
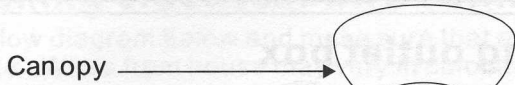
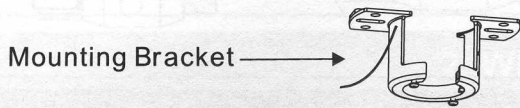

Hardware Bag

For Mounting Plate:

Flat Washer	x2		
Spring Washer	x2		
Machine Screw	x2		
Wood Screw	x2		

For Blade Installation:

Flat washer x 13 (one spare washer included)



Blade Screw x 13 (one spare screw included)

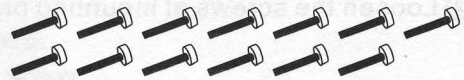

For Wire Connection:

Wire Nut x 3

For Fan and Light:

Pull Chain Knob x1

For Blade Balance :

Balanced slide x 1

Weight block (3G x 3)



Blade Set (packed separately)

For 4TB53
(Palm Leaf Resin Blades)

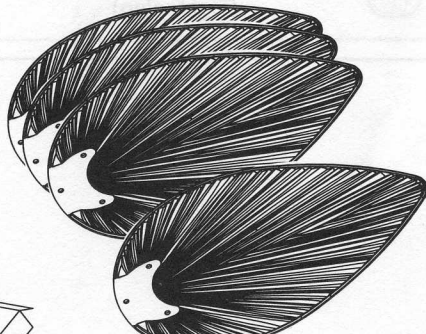

For 4TB54
(Large Oval Distressed Walnut Wood Blades)

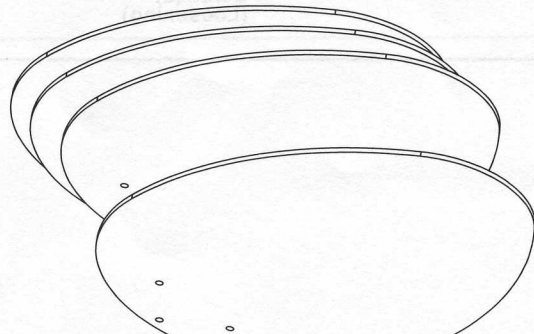

WARNING: blades should be at least 7 feet from floor

Note 1:

Turn off power at breaker box to avoid possible electrical shock.

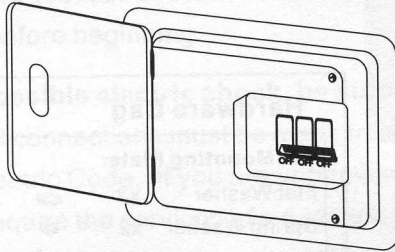

Note 2:

Use metal outlet box suitable for fan support.
Outlet box must support 35 lbs min.

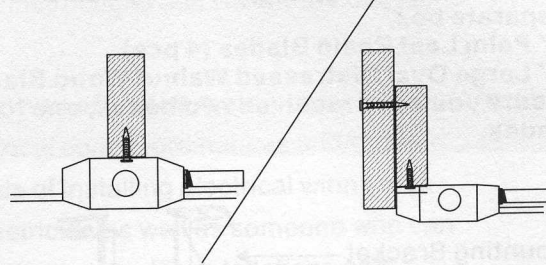

1. HANGING SYSTEM INSTALLATION

1A. Installing mounting bracket to ceiling outlet box

- 1 Install mounting bracket to outlet box in ceiling by using screws included with the outlet box and washers from the hardware bag.
- 2 Loosen the screws at mounting bracket.

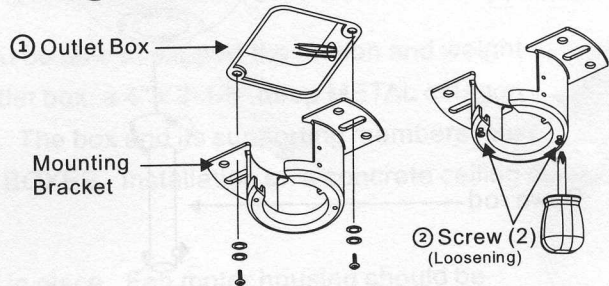

1B. Installing Downrod and Yoke

- 1 Remove cross pin and cotter pin from downrod.
- 2 Insert downrod through canopy and yoke cover, and feed motor lead wires through downrod.
- 3 Loosen 2 downrod jam screws at yoke. Insert downrod assembly into yoke.
- 4 Insert the cross pin through yoke & downrod and secure with cotter pin.
- 5 Tighten both downrod jam screws to further secure downrod.
- 6 Pull down the yoke cover to cover yoke.

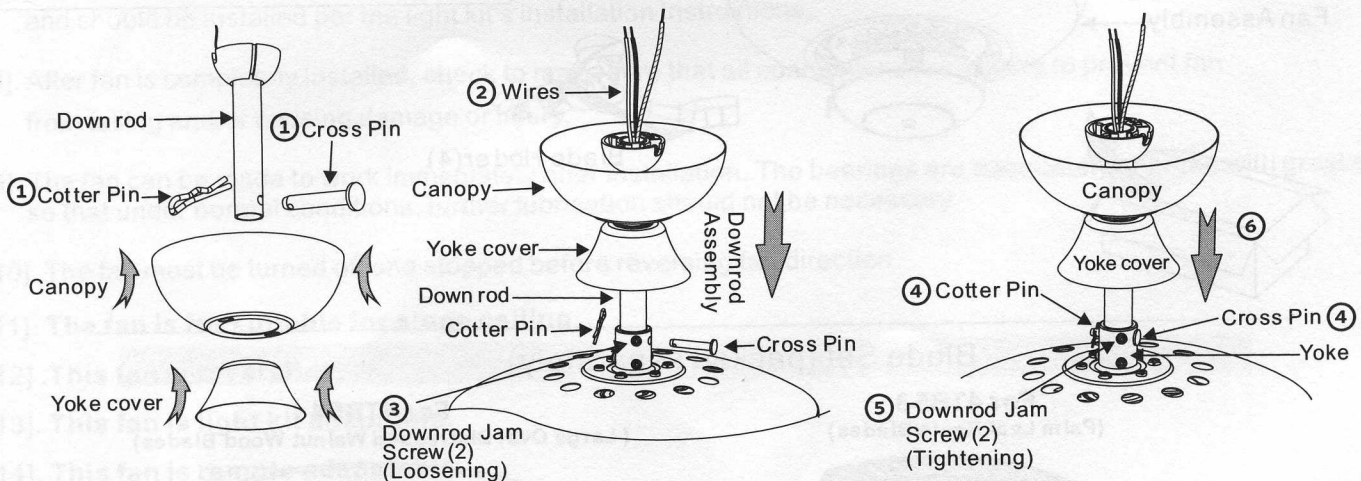

1C. Hanging the fan

Lift fan assembly onto mounting bracket.

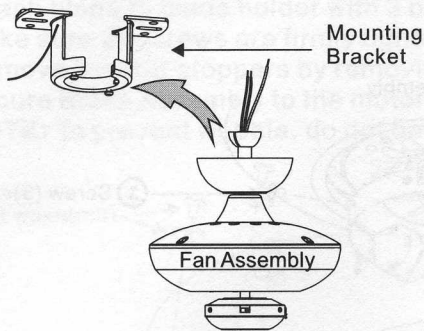

Rotate fan so that the groove on the ball engages the ridge in the mounting bracket.

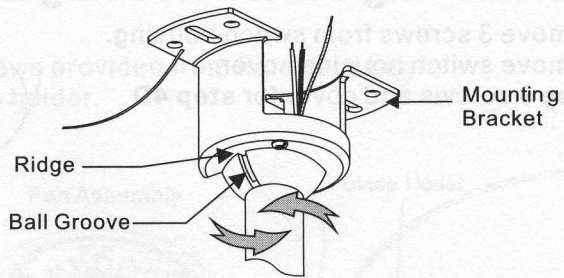

2. WIRE CONNECTION

Making electrical wire connection

Follow diagram below and make sure that all exposed wires are secured inside wire nuts or terminal block.
Note : Wires from house may vary in color and may not include ground wire (green).

- *White wire from house to white wire from fan
- *Black wire from house to black wire from fan
- *Ground wire from house to green wires from downrod and from mounting bracket
- *Secure with twist - lock wire nuts (provided from hardware bag)
- *Gently push wires into junction box with wire nuts pointing upward.

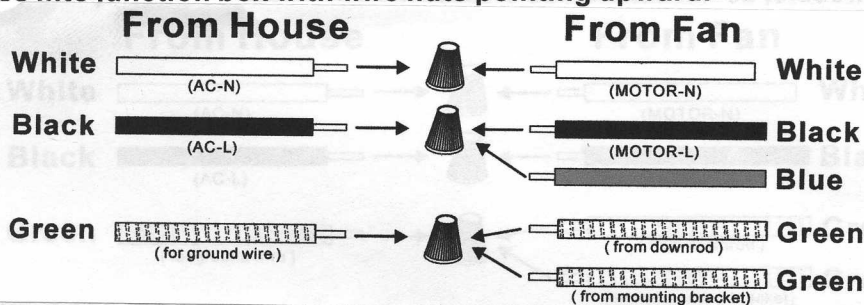

3. CANOPY INSTALLATION

Note: Two screws are pre-installed on mounting bracket for canopy installation.

- ① Push up canopy until two screws pre-screwed on mounting bracket are engaged with two key holes on canopy.
- ② Rotate canopy slightly until two pre-installed screw heads are engaged in the narrow end of key holes.
- ③ Tighten both screws.

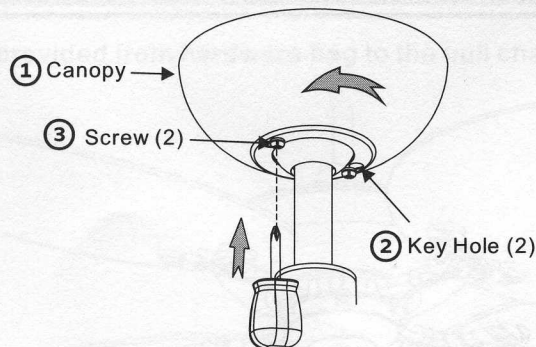

4. BLADE INSTALLATION

4A. Removing Switch Housing Cover

- ① Remove 3 screws from switch housing.
- ② Remove switch housing cover.
- ③ Keep 3 screws and cover for step 4D.

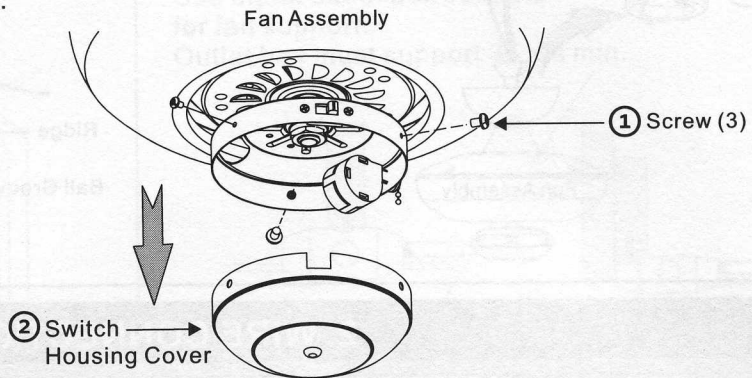

4B. For 53" Palm Leaf Resin Blades (Dual Side Use)

- ① Attach blade to blade holder with 3 blade screws and 3 paper washers provided from hardware bag. Make sure all screws are firmly tightened.
 - ② Remove 3 motor stoppers by removing screws.
 - ③ Secure Blade Assembly to the motor with 2 motor screws provided from hardware bag.
- NOTE:** To prevent wobble, do not bend blade or blade holder.

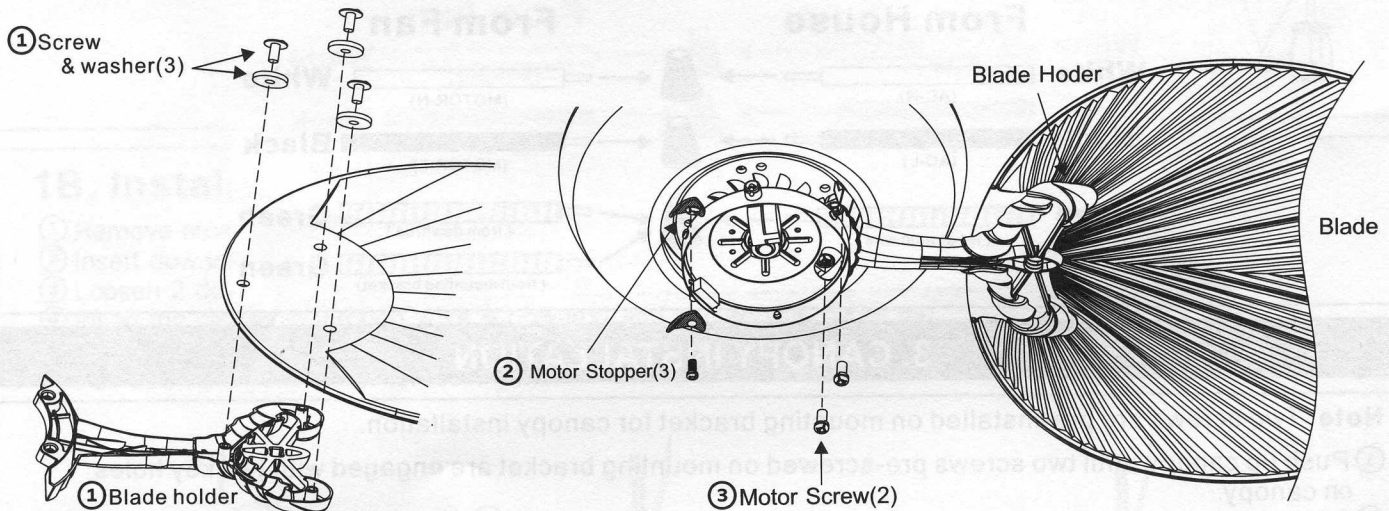

4C. For 54" Large Oval Distressed Walnut Wood Blades

- ① Attach blade to blade holder with 3 blade screws and 3 paper washers provided from hardware bag. Make sure all screws are firmly tightened.
 - ② Remove 3 motor stoppers by removing screws.
 - ③ Secure Blade Assembly to the motor with 2 motor screws provided from hardware bag.
- NOTE:** To prevent wobble, do not bend blade or blade holder.

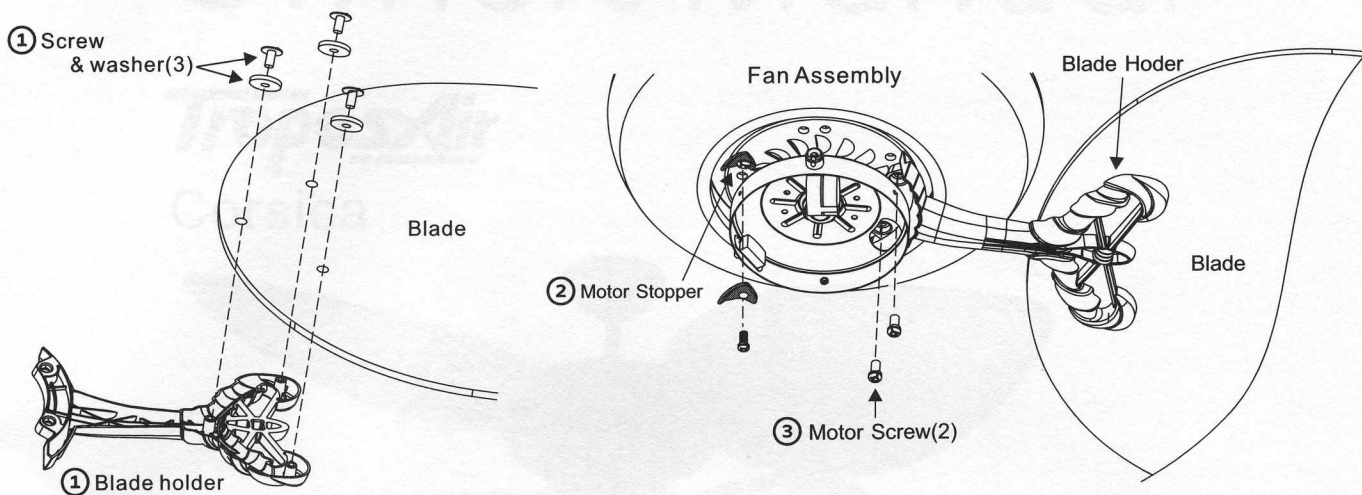

4D. Installing Switch Housing Cover

Put the cover back to the switch housing and tighten with 3 screws removed from **step 4A**.

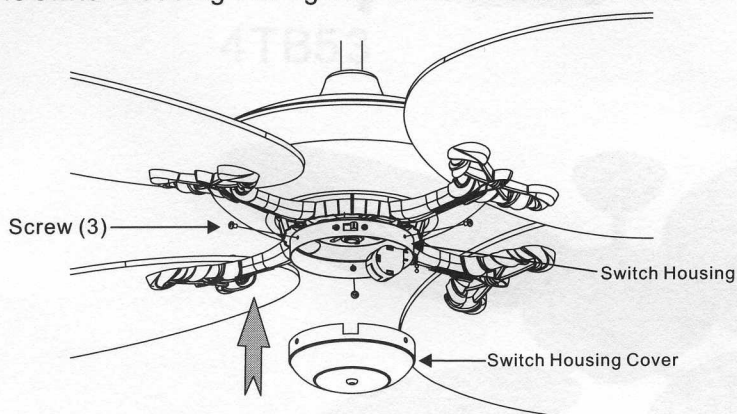

5. PULL CHAIN KNOB INSTALLATION

Connect Pull Chain Knob provided from hardware bag to the pull chain from switch housing.

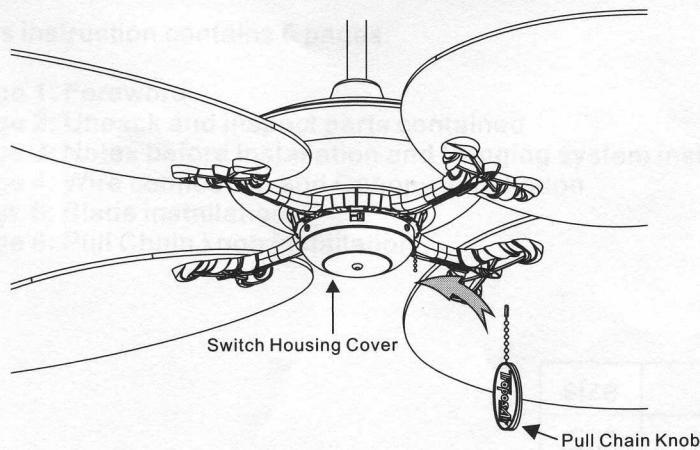

6. Turn on power at breaker box for operation.

