

zogics

NSPIRE

H13 HEPA AIR FILTRATION SYSTEM

User Manual



Thank you for purchasing Zogics NSpire H13 HEPA Air Filtration System.

Please read this user manual carefully before you use the appliance.

After reading this manual, keep it in a convenient location for further reference.

Contents

Performance Indicators	1
Packing List	2
Filter Features	2
Product Overview	4
Circuit Diagram	4
Install Filter	5
Control Overview	6
Function Descriptions	8
Installation Notice	9
Safety Precautions	10
Mandatory Items	12
Cleaning and Maintenance	13
Replacing the Filters	15
Troubleshooting	16

NSPIRE

H13 HEPA AIR FILTRATION SYSTEM

zogics

Performance Indicators

SKU	NSP-HEPA
Product Name	Zogics NSpire H13 HEPA Air Filtration System
Rated Voltage	110V~120V~
Rated Frequency	50Hz/60Hz
Power	80W
Noise (Low)	≤29.4dB
Ionizer	706 ft ³
CADR (PM2.5)	11,300 ft ³ /h
CCM (PM2.5)	P4
CADR (Formaldehyde)	2,825 ft ³ /h
CCM (Formaldehyde)	F4
Application Area	236~409 ft ²
Filter Replace Time	Filter #1: 2 years Filter #2 & 3: 6 months
Net Weight	18.75 lbs
Product Size	14.5" x 7.7" x 26.2"
Packing Size	16.5" x 10" x 28.3"
Purification	Pre-filter, Cold-catalyst, Activated carbon removal filter, Antibacterial filter, HEPA filter, UV Sterilization, Anion release

- For product maintenance and filter replacement cleaning information, please refer to the instruction manual
- Purification performance parameters are tested under specific third-party laboratory conditions with specific dust particles and formaldehyde gas as target pollutants
- The recommended area is calculated according to (0.07~0.12) xCADR particles, which is the theoretical value. With different use environment and building structures, the applicable area will also change due to various factors such as the degree of indoor pollution.

Packing List

NSpire H13 HEPA Air Filtration System	x 1
Remote Control	x 1
Filters	x 3
User Manual	x 1

Filter Features

Aluminum Pre-Filter

Removes large granule dust, dander, pollen, floating compounds and other pollutants.
Washable and reusable.

Cold Catalyst Filter

The cold catalyst will play a catalyst effect in a normal living environment without any external assistance like UV light, sunlight, high temperature or pressure.

The cold catalyst deals with formaldehyde, ammonia, benzene, TVOC, hydrogen sulfide and other harmful gases released by plywood, furniture, wallpapers, carpets, curtains and bedspreads.

Honeycomb Activated Carbon Filter

The honeycomb activated carbon carries efficient additives. It features good absorption and dust collection characteristics.

Antibacterial Filter

The 5 microns filter with antimicrobial agents can efficiently kill bacteria in the air.

High Efficiency H13 HEPA Filter

The precision of the HEPA filter is 0.01 micron, and it is able to eliminate particles which are larger than 0.01 micron with a filtration rate of 99% or more. Dust, bacteria, fungi, viruses, allergens and other small and tiny particles are not able to get through the HEPA filter.

Filter Features (cont.)

UV Sterilizing Light

A variety of bacteria can be killed by the 365nm UV light. The UV germicidal lamp is used to purify the air and eliminates odor caused by smoke and mold.

Anion Release

The ionizer releases a large amount of anions and makes the oxygen negatively-charged, thus gathering positively-charged particles like floating dust, bacteria, viruses and smoke.

The particles become denser and sink to the ground. The smaller the particle size, the higher the capture rate.

Product Overview

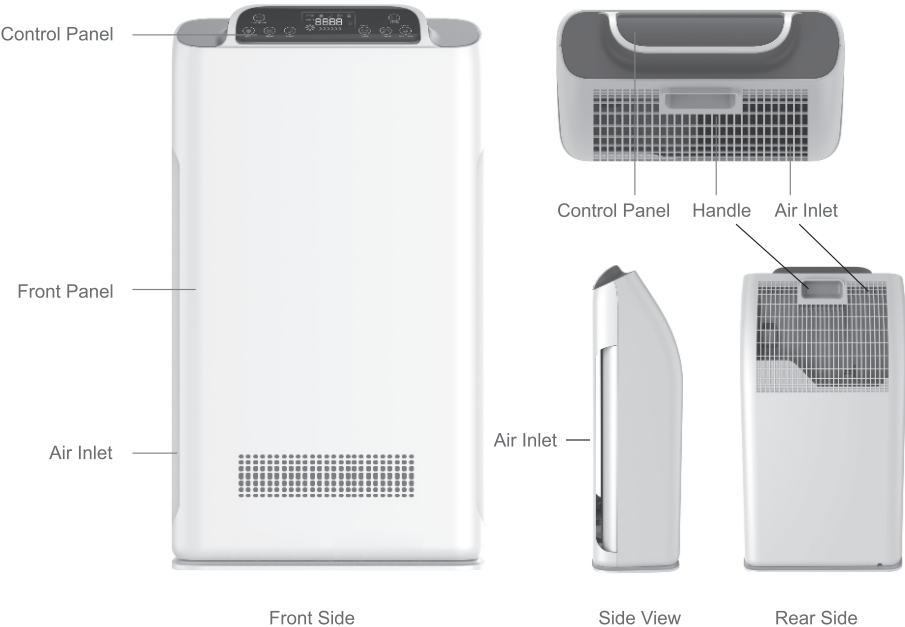

Circuit Diagram

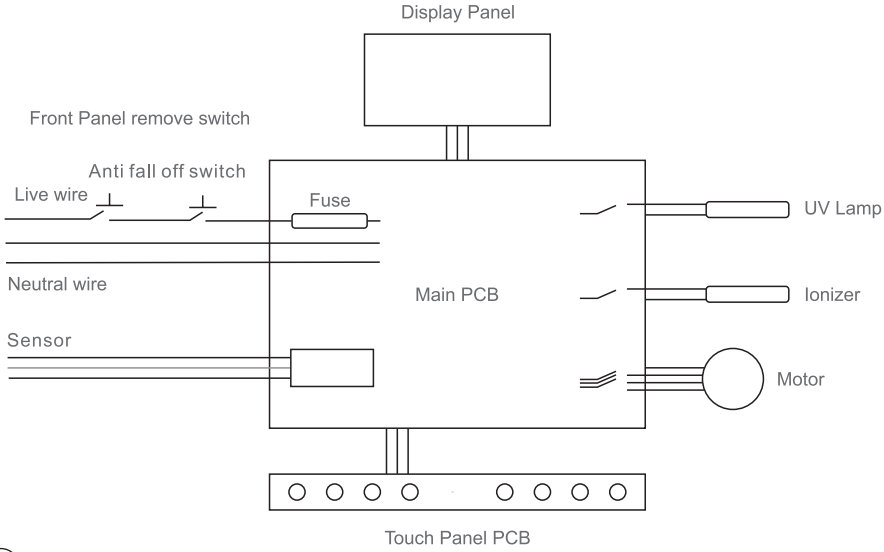

Install Filter

1. Take out filter from machine

- Open the cover

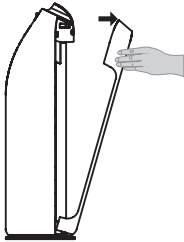
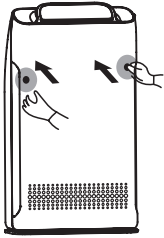

- Take out the filters

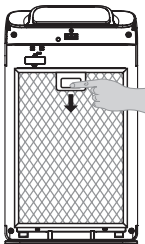

- Remove all packaging material; Filters are wrapped in plastic, this MUST be removed before use

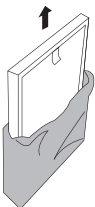

2. Install filter and front panel

- Install filter 3 (Antibacterial + HEPA Compound Filters)
Note: Please ensure the tab side is facing you.

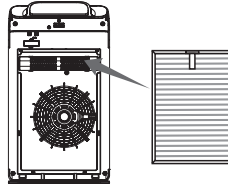

- Install filter 2 (Cold catalyst + Activated carbon removal compound filters)
Note: Please ensure the tab side is facing you.

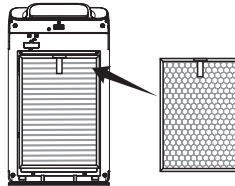

- Install filter 1 (Pre-Filter)
Note: Please ensure the handle side is facing you.

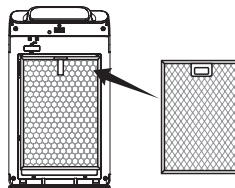

- Install front plate

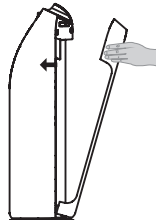

Control Overview

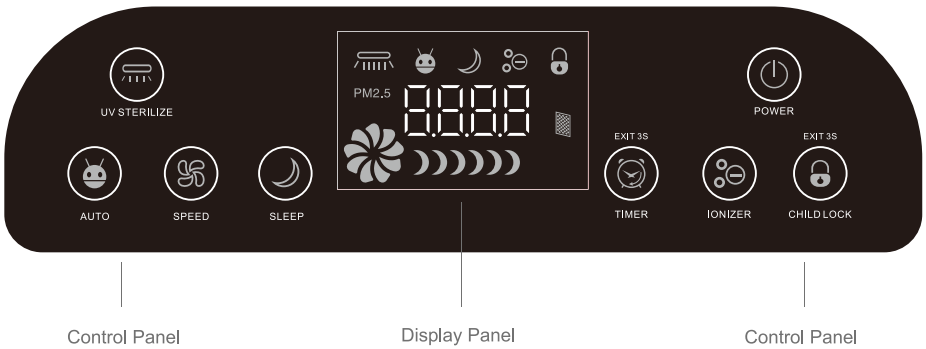

1. Switch the unit on



Touch the power button at standby mode. Machine will start at the last time running mode (not including timer and sleep mode). Machine will go into standby mode after pressing the power button when it is on running mode. It will record the current operation mode at the same time. Note: The machine includes panel switch and anti-fall switch. Machine will not turn on when the panel is removed or the machine falls down.

2. Select the operating mode



All buttons will disable when the child lock is pressed. The child lock icon will light up and the unit will keep running. Press this button for 3 seconds to exit this mode.



Ionizer will turn on/off when you press this button. The icon will light up and off accordingly. Motor will turn on and stay at low speed mode if you press this button while on standby mode.

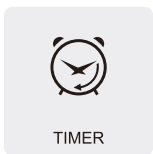

Press this button to set the working time. Every press increases the time by 30 minutes. It will recycle after 12 hours. You can press 3 seconds to exit this mode. The machine will go into standby mode and exit timer mode if you press this button but the machine is not on purifying mode.



UV STERILIZE

This function can be engaged when you press the UV sterilize button when the machine is running. Icon will light up or off at the same time. Motor will turn on and stay at low speed mode if you press this button on standby mode.



AUTO

This button puts the machine into auto mode, and the "Auto" indicator lights up on the panel. Under this mode, according to the degree of air pollution, the machine will automatically start working and adjust to the correct air volume: $PM_{2.5} < 60$ (Low speed), $60 \leq PM_{2.5} < 150$ (Medium speed), $PM_{2.5} \geq 150$ (High speed)



SLEEP

The display panel and light will turn off when sleep mode starts. Motor will only work at low speed. Timer is available in this mode. Machine will be in standby mode after the time setting finishes. Press any button to exit sleep mode.



SPEED

Press this button to adjust the motor speed to Low (500RPM), Medium (700RPM), High (900 RPM) and let the machine exit auto mode. The motor speed won't be controlled by the sensor if it's modified without permission.



Accumulated working time of the filter

Press child lock for 5 seconds when at normal working mode (child lock mode will not start), it will show accumulated working time of the filter. It will disappear after 3 seconds.

3. Power off



POWER

When the machine is running, it will turn into standby mode when pressing this button.

Function Descriptions

1. Remote Control

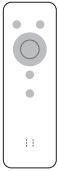

The product is equipped with a remote control, which uses a button cell battery (if you don't use the remote control for a long time, please take out the battery). Note: The buttons on the remote control correspond to the buttons on the operation panel. Operation methods are exactly the same.

2. Product Use

Intelligent operation: Connect the machine to a power supply, press the power button and the auto button, and the machine will run using the sensor. The operation of the motor gear will follow the sensor's adjusted value. This operation can be used for the vast majority of applications.

Personalized operation: Connect the machine to a power supply, press the power button, choose your fan speed selection, and select on or off negative ions and the UV germicidal lamp.

When running the above two kinds of operating modes at night, as long as the sleep button is set, this will reduce the fan speed to low, and lessen the noise from the unit.

Regular operation: Simply press the timer icon to set the machine's running time, and it will stop running automatically after the time is up. (If you need to cancel, press the timer icon on the panel 3 seconds to cancel this function.)

Child Lock mode: When in child lock mode, the control panel and buttons on the remote control can not work. To cancel, press the child lock button 3 seconds or press the unlock button on the remote control).

3. To Set the Time

Press the smart key for 5 seconds to bring up the time display: when the Hour digits are flashing, press the speed key to add 1, press the sleep button to subtract 1, set "Hour" by clicking the smart key again.

When "Minutes" digits are flashing, press the speed button to add 1, press the sleep button to subtract 1. (Press the smart key back and forth for hours and wind speed. Press the wind speed and the sleep button to add or subtract).

Note: The clock function of this machine is completely independent, time display function accuracy does not affect the purification.

The battery is powered by the circuit board of the machine, and it will run out if the machine is not plugged in. The battery is designed for 10 days standby and will run out if the machine is unplugged for more than 10 days. The clock function automatically resets when this happens. You will need to set the clock again.

Installation Notice

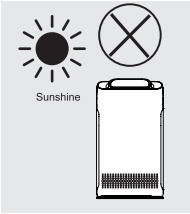

1. Do not place it on the following:

- Direct sunlight or facing the outlet of an air conditioner, or direct heat. May cause deformation, deterioration, discoloration and malfunction.

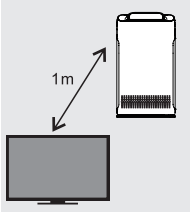

- Close to televisions and radios and other nearby equipment. Please place the unit more than 3 feet away.

2. This product should be placed on the ground.

Pollen, dust and other easily fall near the floor, it is recommended that the product be placed on a flat floor in the room.

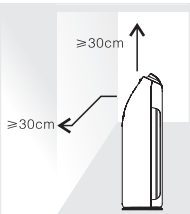

3. In order to make effective air circulation in the room:

There should be a gap of at least 8" at both sides and back of the product, and 12" from the top surface.

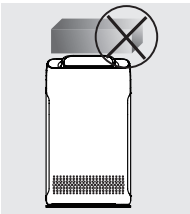

4. Do not place anything on the product, otherwise it may cause the unit to malfunction.

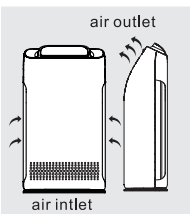

5. Do not block the air inlet and outlet. For example, do not place anything on the outlet or front air inlet.

Safety Precautions

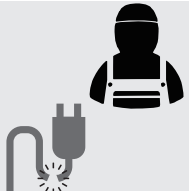

1. Do not lift or move the machine when it is working.

Never pull the cord when moving or storing, this may cause a short circuit or damage to the power cord, starting a fire or an electric shock.

2. Do not damage the power cord or plug, do not cut, excessively twist, pull or use a reverse power line.

If the power cord is damaged, to avoid danger, the cord must be replaced by the manufacturer, maintenance department or professional staff.

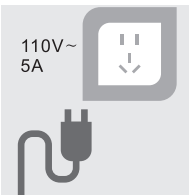

3. Do not use beyond the rated power, universal socket or connected devices, this may cause the cord to overheat and cause a fire/accident.

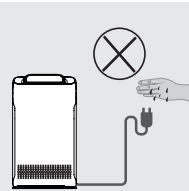

4. Do not touch the power plug with wet hands, it may cause electric shock.

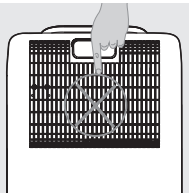

5. Do not place fingers or metal objects into the air outlet gap, this may cause electric shock.

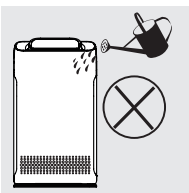

6. Do not let water, flammable detergent or other liquid into the unit, this may cause electric shock or fire.

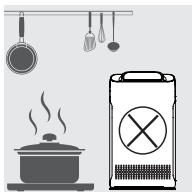

7. This product is not supposed to be used as a daily ventilator, dust cleaner or cooker hood.

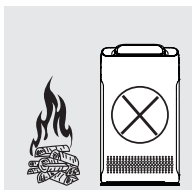

8. Do not use this product near gas appliances, heating devices or stoves.



9. Do not use this product in a humid or high-temperature environment (bathroom, kitchen).



10. Do not allow children to have access to the remote control.

11. Do not place in unstable places

(Products may drop, be overturned, resulting in injury, causing leakage, electric shock or fire).

12. Do not use air filter in an aromatherapy scented or disinfecting/insecticide environment

(chemical residues may accumulate in the machine, then be released from the outlet causing harm to your health).

13. After using a disinfectant or insecticide, you should thoroughly ventilate the room before using the air filter.

Mandatory Items

1. When the following occurs, please immediately turn off the power to the machine

(May cause electric shock, sparks, or smoke)

- Abnormal sound or vibration during operation
- Product odor, burnt smell

2. Please regularly clean the power plug

(May cause electric shock, sparks, or smoke)

- Pull out the power plug, wipe with a dry cloth
- If you won't be using the unit for long time, please unplug

3. Before maintenance, make sure to disconnect the power

- Products may suddenly start, causing electric shock and injury

4. Please safely insert the plug into the socket

- Do not use damaged plug or loose power socket

5. Please hold the plug insulation parts to pull out power plug

- Using the power cord to pull off the plug from the power cord may cause power cord damage, electric shock, short circuit, and/or fire

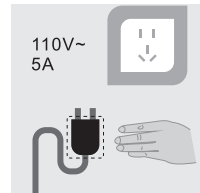

6. When any of the following occurs, please immediately turn off the machine

- A switch does not work
- The power cord or plug abnormally heats up
- Abnormal sound or vibration
- Any anomalies or malfunctions

7. Non-professional people are not allowed to install or uninstall the machine

For IEC:

This appliance is not intended for use by persons (including children) with reduced physical, sensory or mental capabilities, or lack of experience and knowledge, unless they have been given supervision or instruction concerning use of the appliance by a person responsible for their safety. Children should be supervised to ensure that they do not play with the appliance. If the power cord is damaged, it must be replaced by the manufacturer, its service agent or similarly qualified persons in order to avoid a hazard.

For EN:

This appliance can be used by children aged from 8 years and above and persons with reduced physical, sensory or mental capabilities or lack of experience and knowledge if they have been given supervision or instruction concerning use of the appliance in a safe way and understand the hazards involved. Children shall not play with the appliance. Cleaning and user maintenance shall not be made by children without supervision.

Cleaning and Maintenance

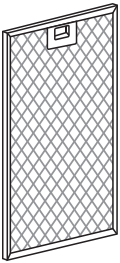

1. Pre-Filter (Every 15 days)

- Please use a vacuum cleaner to clean the dust on the surface of the screen, or wash with water, dry thoroughly.

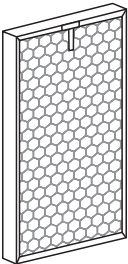

2. Cellular-Activated Carbon Filter (Every 2 months)

- Use a vacuum cleaner to clear the dust on the surface of the screen.
- Place the filter into a ventilated place. Don't expose the filter to strong sunshine.
- Do not forcibly hold the filter.
- Do not use water to clean the filter.

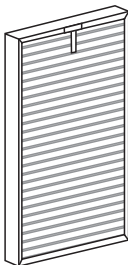

3. Antibacterial / HEPA Filter (Every 2 months)

- Place the filter into a ventilated place. Don't expose the filter to strong sunshine.
- Do not use water to clean the filter.

Cleaning and Maintenance (cont.)

4. Negative Ion Generator

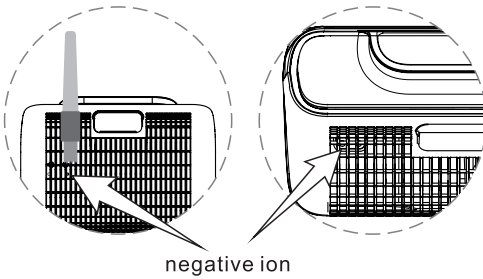

If the machine creaks, use the brush pen as a cleaning tool, and regularly clean the dust around the negative ion.

5. Particle Sensor (every 2 months)

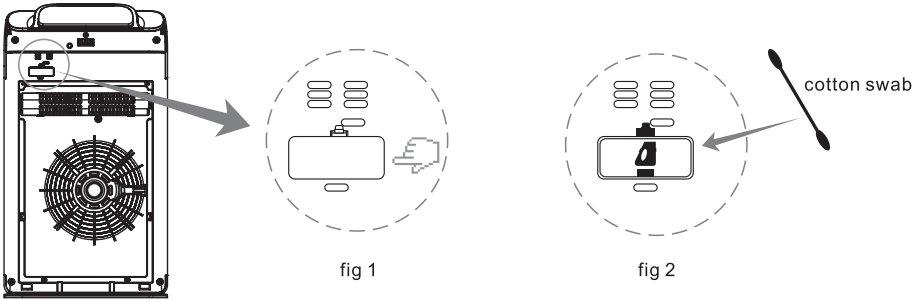

- With a dry cotton swab, regularly clean the lens to remove the moisture and smoke.
- Remove the outer cover of the particle sensor (fig 1), use the dry cotton swab to clean the lens (fig 2).
- Please disconnect the power before cleaning.

Cleaning and Maintenance Tips

- Disconnect the power before cleaning and maintenance
- Do not open the machine when removing the filter
- Please unplug if the machine is not in use for a long time
- According to locations and air quality (e.g. a family with many smokers or a place with serious pollution), the filter life will be shortened. Please replace the filter accordingly.

Replacing the Filters

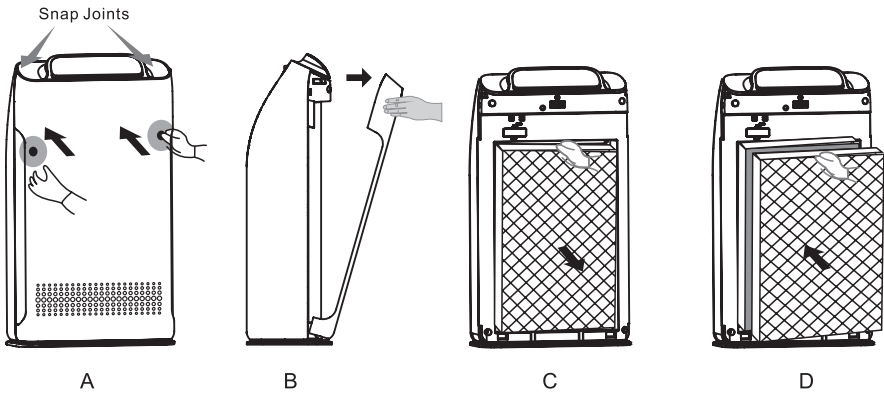

- A. Press the middle of the front panel to pop the upper button out of its position
- B. Pull out the front panel
- C. Take out the filters one by one
- D. Fill in new filters one by one in a correct sequence

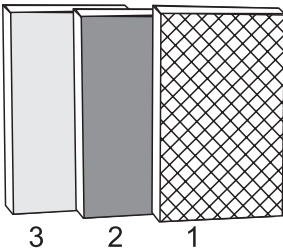

- 1. Pre-Filter
- 2. Cellular-Activated Carbon / Cold Catalyst Filter
- 3. Antimicrobial / HEPA Filter

- We suggest maintaining No.1 filter every 15 days
- We suggest maintaining No.2 and No.3 filters every 60 days
- We suggest replacing No.1 filter in every 2 years
- We suggest replacing No.2 & No.3 filters every 6 months

Filter change reminder

The machine has a filter change reminding function. It's set at 1500 hours. Please replace No.2 and No. 3 filters when the "change" icon lights up. Also please press the child lock button for 5 seconds to reset this function.

Troubleshooting

Problem	Solution
Can not turn on or unit has no response	<ol style="list-style-type: none">1. Is the power cord plugged in?<ul style="list-style-type: none">• Plug in the power.2. Is the machine front plate covered?<ul style="list-style-type: none">• Cover the front plate3. Is the machine in the Child-lock mode?<ul style="list-style-type: none">• When the display shows "child-lock" press the child-lock button 5 seconds until the light is off.4. The machine is in a flat place?<ul style="list-style-type: none">• Put the machine on a flat surface.
The air is dirty, but the indicator still shows a green color, even after continuous operation, the indicator is always displayed in red.	<ol style="list-style-type: none">1. Is the machine located in a place that does not easily absorb the dirty air?<ul style="list-style-type: none">• Change the location.2. Particle sensor is dirty?<ul style="list-style-type: none">• Clean the sensor.
Sound during operation	The negative ion generator is dusty? <ul style="list-style-type: none">• Clean the negative ion generator.
The unit is outputting a strange smell	<ol style="list-style-type: none">1. Is the filter dirty?<ul style="list-style-type: none">• Clean the filter.2. Has the filter not been changed for a long time?<ul style="list-style-type: none">• Replace with a new filter.
Unit does not go into sleep mode automatically at night.	Is the unit in manual mode? <ul style="list-style-type: none">• Press "Auto" button on the control panel
The filter has been running for a long time, but the air quality has not improved.	<ol style="list-style-type: none">1. Have you removed the filter bag ?<ul style="list-style-type: none">• Please remove the filter bag before using the first time.2. Is the installation order of the filters wrong?<ul style="list-style-type: none">• Follow the proper filter Installation sequence.
Display shows "F1" or "F2"	Please turn off the power immediately and contact the manufacturer for maintenance.

zogics