

zogics

# NSPIRE **PRO**

PREMIUM H13 HEPA AIR FILTRATION SYSTEM

User Manual



**Thank you for purchasing Zogics NSpire PRO Premium H13 HEPA Air Filtration System.**

Please read this user manual carefully before you use the appliance.

After reading this manual, keep it in a convenient location for further reference.

# Contents

Performance Indicators .....	1
Product Functions .....	2
Product Features .....	2
Filter Screen Features .....	2
Product Structure .....	3
Primary Effect Filter Screen .....	4
Requirements for Product Placement ..	6
Installing the Filter .....	6
How to Use .....	7
Maintenance .....	10
Do's and Don'ts .....	14
Packing List .....	15
Troubleshooting .....	16

**NSPIRE** **PRO**

PREMIUM H13 HEPA AIR FILTRATION SYSTEM

**zogics**

# Performance Indicators

<b>SKU</b>	NSP-HEPA-PRO
<b>Product Name</b>	Zogics NSpire PRO Premium H13 HEPA Air Filtration System
<b>Voltage/Frequency</b>	AC 110~120V, 50/60Hz
<b>Rated Power</b>	85W
<b>Noise</b>	≤66dB(A)
<b>Anion Concentration</b>	353 ft <sup>3</sup>
<b>CADR (PM2.5)</b>	28,251 ft <sup>3</sup> /h
<b>CADR (Formaldehyde)</b>	10,594 ft <sup>3</sup> /h
<b>Filter Replace Time</b>	Filter #1: 2 years Filter #2: 6 months
<b>Application Area</b>	Areas up to 1,033 ft <sup>2</sup>
<b>Net Weight</b>	30.8 lbs
<b>Product Size</b>	15.75" x 15.75" x 26.3"
<b>Order of Cleaning</b>	1. Pre-Filter 2. Composite Carbon Cloth Filter (HEPA + Activated Carbon) 3. Anion Purifier

# Product Functions

- Purification of gaseous pollutants such as smoke, dust particles and formaldehyde, etc.
- Reduced amounts of anions which can improve the air quality and optimize the living environment
- Filtration, sterilization and air purification for home, office, restaurants, bars and entertainment venues with areas up to 1,033 sq. ft

# Product Features

- Four-color LED lamp to indicate the air quality.
- Dual filter screens to filter and output fresh air.
- Built-in high accuracy particulate matter sensors for real-time detection of air quality.
- Manual operation control and automatic control during night time or when sleeping.
- Four purification modes - manual, automatic, speed and sleep.

# Filter Screen Features

- Primary Filter screen: Can filter out large particles such as human hair, pet fur, cotton fiber etc.
- H13 HEPA Composite Filter screen: filters out smoke, dust, pollen, allergens, pollutants and fine particles larger than 0.3 microns, also filters out harmful gases such as benzene, formaldehyde, etc.

# Product Structure

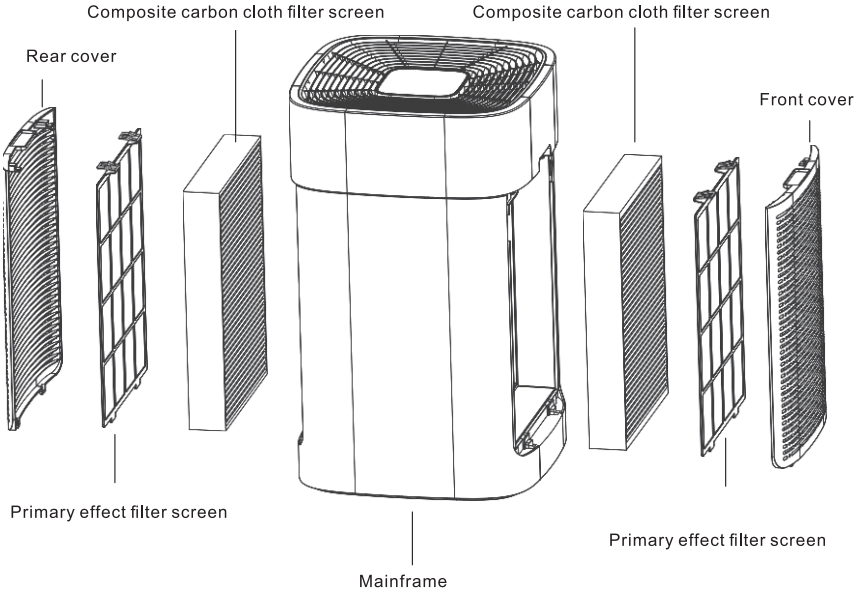
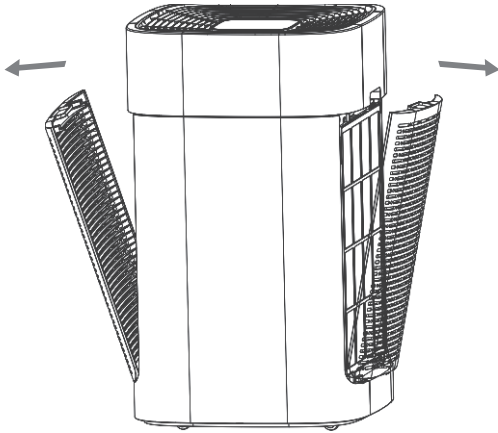











# Primary Effect Filter Screen



On the display panel, there's an on/off key, function key, consumable status display and working status display.

## 1. On/Off Key and Function Key Display

	Standby	On
On/off key	 Red	 Green
<b>Function key display</b>		
Mode 	Wind speed 	Child lock 
Timer 	Filter screen 	Automatic 
Speed 	Sleep 	

## 2. Replacement Reminder for Filter Screen



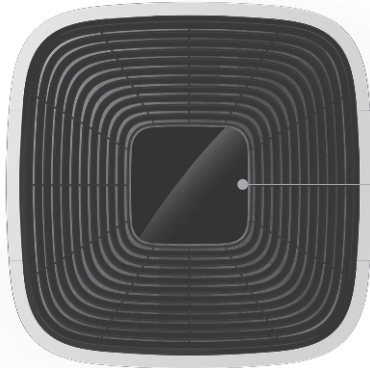

This machine has a Filter Screen regular replacement reminder function. The replacement time is set as 3,000 hours. When the machine runs up to the given time, the indication lamp on the panel will light and prompt the user to replace the filter screen. Meanwhile, the reset function can be restarted again by pressing the Filter Screen key. (Hold this key for 3 seconds to reset the time and restart timing.)

	Normal	Expire	
HEPA composite filter	No display		Red lamp

## 3. Air Quality Status Indication



Air quality indication lamp

Blue (Excellent)	Green (Good)	Yellow (Fair)	Red (Poor)
			

# Requirements for Product Placement

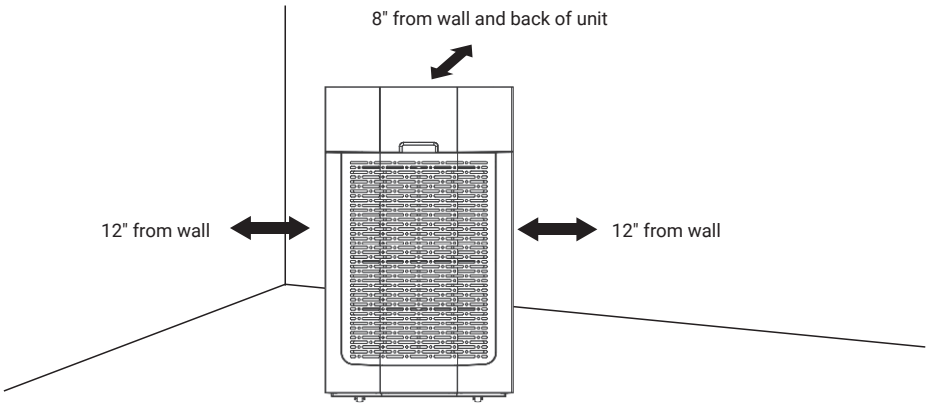

When the filter is working, please allow 8" space behind the unit and 12"+ on both sides.

## Installing the Filter

### 1. Remove the filter from the plastic bag

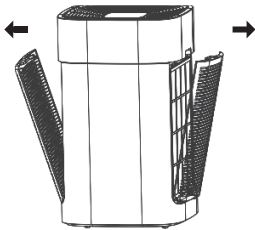

A. Remove the front and rear covers

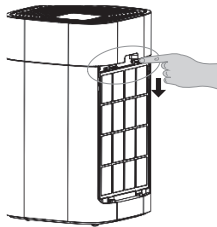

B. Remove the filters

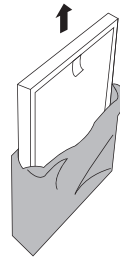

C. Take the filter out of the packaging. Make sure to remove the plastic bag from the filter before use.



## Installing the Filter (cont.)

### 2. Installing the filter and covers

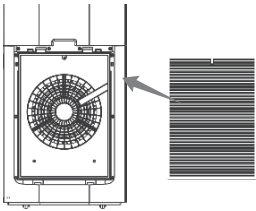

**A.** There are differences between the inside and the outside of the dust filter. Note: The side with a handle should be placed outwards.

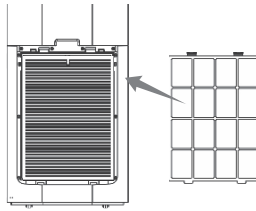

**B.** There are differences between the inside and the outside of the front filter. Note: The side with a handle should be placed outwards.

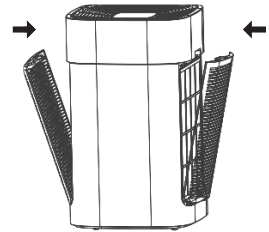





**C.** Install the front & rear covers. The machine will not run if the covers are not in place.

## How to Use

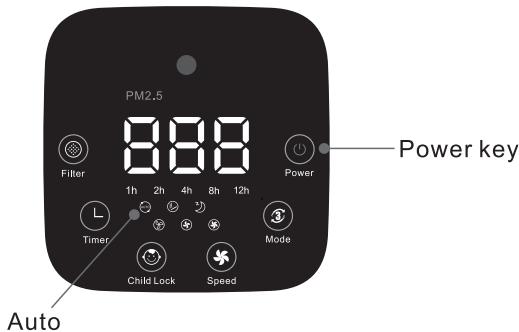
### 1. Connect the power

For the first time use, take out the product from the packaging, remove the power cable tie, and insert the plug into the socket. After the unit is connected to power, the key icon on the panel will turn red.





Lightly touch on the power key . The machine will start with a chord ringtone, power key will turn green  and the machine will enter an automatic mode. Meanwhile, the machine front panel will display in white lamp simultaneously:  (Automatic mode) AUTO.

# How to Use (cont.)

## 2. Mode selection

In the "on" status, the mode key can select 3 modes:

Automatic  / Turbo (for smoke)  / Sleep 

When the **automatic key** is lit, the anion function will start; the motor will shift when receiving the data from the sensor (the indicator will light up when the auto function is on, and will light off when the auto function is off). When the **turbo lamp** is lit, the machine will enter speed purification mode after the speed indication is lit. When the **sleep lamp** is lit, the lamp brightness will reduce by half to indicate the sleep function. The machine can only work on the 1st shift and is not controlled by the sensor.



The timer will work as usual when starting the timing function, and the machine will enter standby status after time is up.

## 3. Manual Mode

When the machine is on, press the wind speed key to shift the motor's gear to adjust the machine running speed. The motor will be not controlled by sensor PM2.5 after manual modification of the motor gear and can only work on Filter Power currently set.

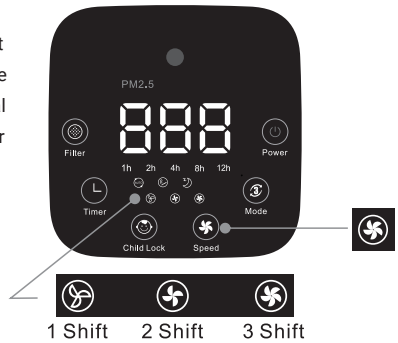

## How to Use (cont.)

### 4. Child lock

When the machine is on, press the child lock for 5 seconds and all keys will be locked, while the machine continues to run at the previous set status before the lock is engaged. The lock status can be relieved by pressing the child lock key for 5 seconds. (The key icon will light when the child lock function is on and get dark when the function closed.)



### 5. Timer

When the machine is on, press this key to turn the timer switch off. When the machine is off, press this key to set the timer switch on, 1 hour will be added by every press, when pressed until 12 hours; the timing function will be closed in the next press. The time can be set in a range of 1-12 hours (The key icon will light when the timing function is on, and doesn't light when timing is off.)

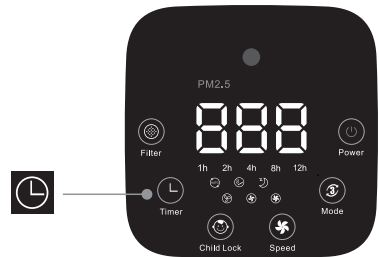

# Maintenance

## 1. Primary Effect Filter Screen

The cleaning frequency is decided by the wind speed, air pollution degree and accumulative time; normally it's cleaned every 2~3 months. Please clean regularly, otherwise the purification efficiency will be affected.

## 2. HEPA Composite Filter Screen

Consisting of HEPA, absorption & purifying material and functionality filtering material, this screen can effectively purify the suspended particles, viruses, and bacteria in the air and remove odors and harmful gases.



## 3. To clean the Primary Effect Filter Screen

Turn off the power, and remove the plug from the socket. Put your hand on the handle and pull outward at an angle, and lift up the rear cover and take it off the purifier.

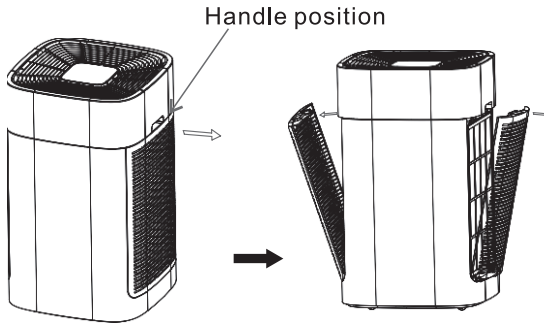

Pull out the primary effect filter screen lightly by holding the two slides, and then pull up it, being careful not to make dust fly out.

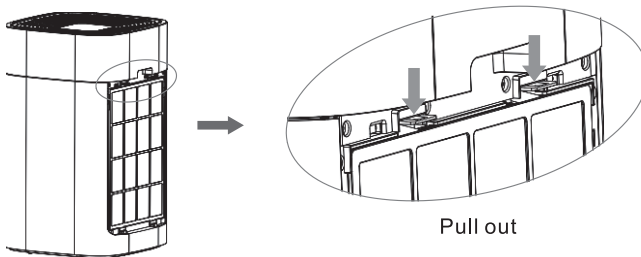

## Maintenance (cont.)

4. The dust can be removed by vacuum cleaner or brush, or be washed by water or detergent if it's too dirty; install it back on the purifier after dry. (Don't bend during the cleaning process to avoid damage.)

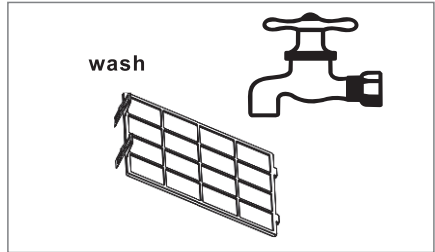
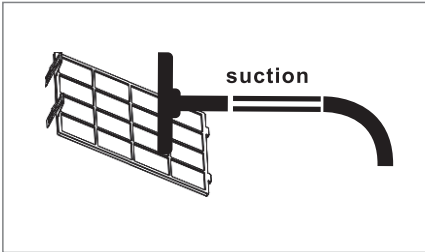

5. Installation method: insert the piece which is under filter screen into the corresponding slot (please note the filter screen's direction, two slides should be outward), then buckle up the upper button stand.

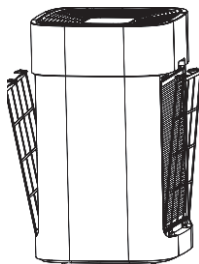

The two inserted pieces going into the slot of the machine frame.

6. Install the filter components back on the product: first put the HEPA composite filter screen, primary effect filter screen, front cover in corresponding positions and insert the inserted pieces into corresponding slots, then combine the front cover and machine card slot by suction.

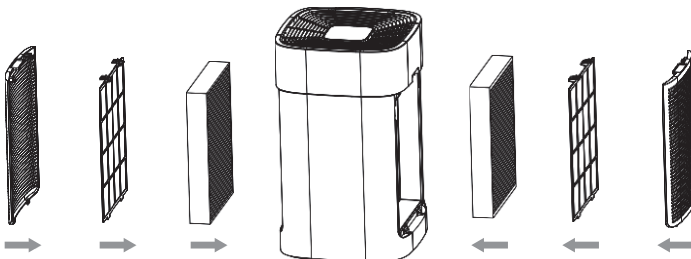

# Maintenance (cont.)

## 7. Smart replacement reminder for filter screen

- A. Turn off the power and remove the plug from the socket.
- B. Open the rear cover and take off the primary effect filter screen in the same way as when 'Cleaning the primary effect filter screen'.
- C. According to the panel replacement indication, take out the HEPA composite filter screen from the machine frame and put a new filter screen into the filter screen frame in sequence, then install the filter components back on the purifier.

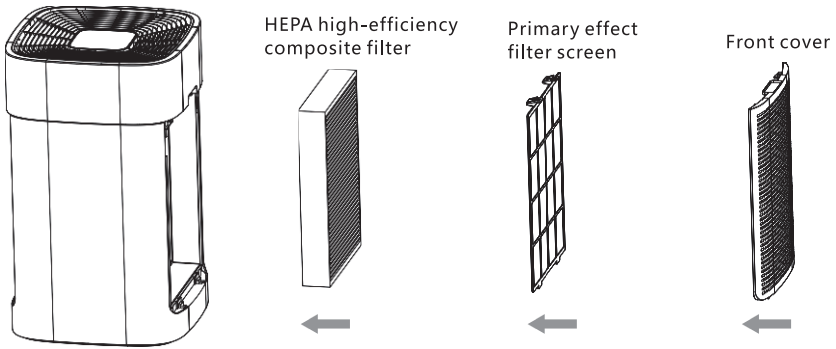

- D. Connect the power and in ON status, press and hold the filter screen key for 5 seconds to reset.

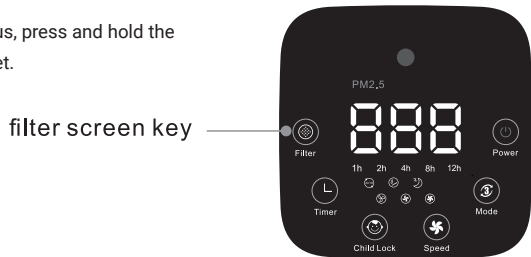

## 8. Finally, switch off the power and install the rear cover on the product frame.

Wipe the sensor lens lightly with a cotton swab after taking off the anti-dust cover. Clean the air sensor door cover with a vacuum cleaner or hair dryer.

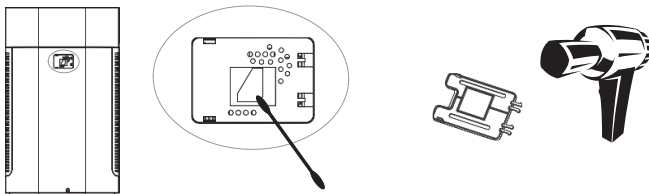

Wipe the sensor lens lightly with cotton swab after taking off the anti-dust cover.

Clean the air sensor door cover by vacuum cleaner or hair dryer.

## Maintenance (cont.)

### 9. Cleaning of air outlet

Wipe off the stains by cleaning with a wipe or cloth; do not use water on the machine. Switch off the power and pull out the plug from the socket. On the air grid side with  $\Delta$  symbol, pull up to remove. Taking out the air grid when running will cause the machine to stop. When finished cleaning, replace the air outlet grid before powering off.

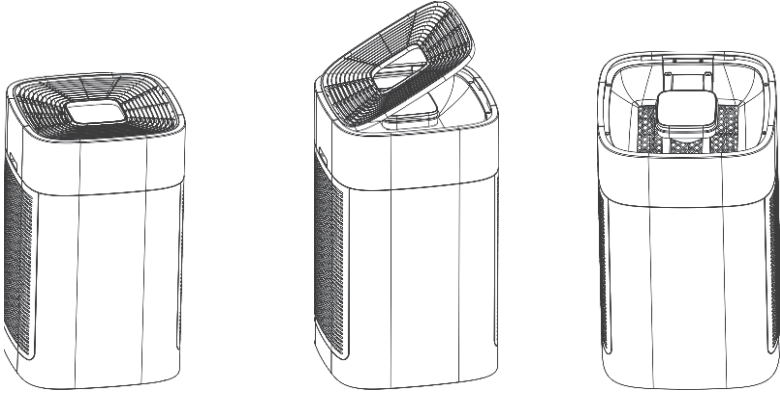

### 10. Particulate sensor (clean approximately once every two months)

Wipe the lens with a dry cotton swab periodically to remove any dirt. (Moisture or tobacco smoke residue may cause it to no longer work properly). Remove the particulate sensor cover and use a dry cotton swab to wipe the lens.

- Do not insert the cotton swab into any area other than the lens.
- Be sure to unplug the power cord.

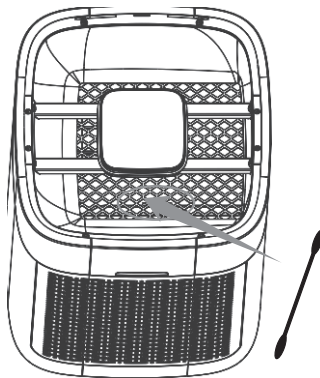

# Do's and Don'ts

## Safety Notes

When the indoor humidity is too high, condensed water will be generated on the air quality sensor. Even though the air quality is very good, the status lamp on the panel will indicate the air quality is bad and will suggest you select the wind volume manually.



Don't touch the power plug with wet hands.



Ensure the power is switched off before cleaning the purifier.



Don't use power in any other form; AC 220V 50Hz is the only type of power that can be utilized for this product.



When the purifier is working, please allow 8" on the backside of the machine from the walls and allow 12" space on both sides. Please place this product on a dry and stable plane for use and do not use near heat sources and overly humid locations.

Don't open the frame and repair this product by yourself; repairs should be done by professional repair people.

Don't pour water, liquid or flammable detergent into the product to avoid product damage or fire caused by electric shock.

When it's not used for a long time, please unplug the unit.

Don't wash the mainframe with solvent and chemical liquid to avoid corrosion on frame.

Do not allow children to touch and use this purifier.

Don't put your hands or any objects in the wind outlet.

The air flow should be kept clear; don't let dust, cotton fiber, hair or other materials block the wind inlet.

Don't pull the power cable to switch off; the power should be switched off safely by holding the plug end and removing.



# Packing List

NSpire PRO Premium H13 HEPA Air Filtration System ..... x 1  
Primary Effect Filter ..... x 2  
HEPA High-Efficiency Filter ..... x 2  
User Manual ..... x 1

# Troubleshooting

<b>Problem</b>	<b>Solution</b>
<b>Unit won't switch on (Power lamp is not lighted)</b>	<p>Is the power plug inserted correctly?</p> <ul style="list-style-type: none"><li>• Insert the power plug.</li></ul> <p>Is the left and right air inlet panel uncovered?</p> <ul style="list-style-type: none"><li>• Cover left and right air inlet panel of purifier.</li></ul>
<b>Unit can't switch on (Power lamp twinkles), button doesn't respond</b>	<p>Is the roof air outlet grid network installed straight?</p> <ul style="list-style-type: none"><li>• Install the roof air outlet grid in place</li></ul>
<b>There's pollution in the air but the indication lamp still hasn't turned 'blue'.</b>	<p>Is the purifier put in a place where it's easy to bring in the polluted air?</p> <ul style="list-style-type: none"><li>• Change the position of purifier.</li></ul>
<b>Even running constantly, the air pollution indication lamp is at 'red'</b>	<p>Is the particle sensor dirty?</p> <ul style="list-style-type: none"><li>• Clean the particle sensor.</li></ul>
<b>'Pop' and 'bang' sounds occur while running.</b>	<p>Is there too much dust in the anion generator ?</p> <ul style="list-style-type: none"><li>• Clean the anion generator.</li></ul>
<b>The outlet is omitting a strange smell.</b>	<p>Is the filter screen dirty?</p> <ul style="list-style-type: none"><li>• Clean the filter screen</li></ul> <p>Has the filter screen not been replaced for a long time?</p> <ul style="list-style-type: none"><li>• Replace the filter screen regularly.</li></ul>
<b>The purifier does not enter sleep mode automatically at night.</b>	<p>Is the purifier running under manual mode?</p> <ul style="list-style-type: none"><li>• Press the 'Automatic' button on the operation panel to ensure the purifier running under automatic mode.</li></ul>



zogics