



MEDIFY AIR

A HIGHER STANDARD OF AIR PURIFICATION



MA-18 AIRPURIFIER

READ AND SAVE THESE INSTRUCTIONS
INSTRUCTION MANUAL AND WARRANTY INFORMATION
Lifetime warranty if replacing filters on time

MA-18/US
Rev: 09/04/21

IMPORTANT SAFETY INSTRUCTIONS:

IN ORDER TO AVOID ANY DAMAGE TO YOU, OTHERS OR PROPERTY, FOLLOW THE FOLLOWING SAFETY PRECAUTIONS:

IF THE POWER CORD OR UNIT DOES NOT WORK, CONTACT MEDIFY CUSTOMER SERVICE IMMEDIATELY.

READ ALL INSTRUCTIONS BEFORE USING.

WARNING — TO REDUCE THE RISK OF BURNS, FIRE, ELECTRICAL SHOCK, OR INJURY TO PERSONS:

- Do not touch power plug with wet hands. Wet hands can cause an electrical shock. Never touch with wet hands.
- Do not take apart or modify unit without authorization. Taking apart or modifying without authorization may cause personal injury or unit malfunction.
- Do not damage power line and socket. Do not bind wires when you use the unit. It may cause an electrical shock, a short circuit, or a fire to happen if you use broken wires. Forbidden to cut, scratch, refit, distort, twist or pull power lines. Do not put any heavy products on top of wires or sockets.
- Prohibited use beyond power. Can only use a 220v unit with a 220v power supply. Can only use a 110v unit with a 110v power supply. You can break or ruin the circuit boards if you plug into a 220v power supply.
- Turn off the power before cleaning machine. Unplug before cleaning to avoid electrical shock or unit turning on accidentally.
- Do not put bars or metal products nearby air outlet or openings. If metal bars touch inside of machine it can cause electrical shock.
- Regularly clean power plug. Do not allow dust to accumulate on power plug. This can damage insulation and cause a fire accident to occur. Pull out the power plug and clean with dry cloth (do not use wet cloth). If not planning to use the machine for any extended period of time, unplug it for safety reasons.
- Please insert the plug completely into the power socket before starting the air purifier. If not, this may cause an electrical shock and overheating, even a fire accident. Do not use damaged plug or loose socket.
- Keep machine dry. Or else it may cause electrical shock or a fire accident to happen.
- Do not use air purifier in a greasy area. This machine should not be used as ventilating or air evacuating equipment.
- Do not use the air purifier in the room with fumigation type pesticides. Chemical residue could be accumulated inside the machine and then released, causing harm. The room should keep ventilated thoroughly after you use an insecticide and then start to use air purifier.
- Do not use solvents like benzene, diluent, etc. to clean the air purifier. This can cause the air purifier to break, to become damaged, or short circuit, which can lead to an electrical shock or even a fire accident happening.
- Keep machine away from volatile substances or flammable items. Otherwise, that could cause a fire to occur.
- Do not use air purifier in high temperature or humid conditions. These situations may cause current damage, an electrical shock, or a fire accident to happen.
- If you use the air purifier in a room with an electric heater, ensure proper ventilation. Otherwise, there could be a buildup of carbon monoxide, which can cause serious harm or death. The air purifier will NOT remove carbon monoxide from the air.
- Be careful when removing the plug from the power socket. Do not pull wires which may cause a short circuit or damage to wires, to avoid a possible fire accident or an electrical shock.
- BEFORE USING THIS PRODUCT, PLEASE MAKE SURE TO REMOVE THE PLASTIC COVERING FROM ALL THE FILTERS.
- Please turn off the power immediately in case of any of the following situations:
 - Malfunction of any switch
 - Any burnt smell, abnormal sound, or shock
 - Circuit failure
 - Any other malfunction
 - Abnormal heating of wires or plugs

SAVE THESE IMPORTANT INSTRUCTIONS FOR EASY REFERENCE.

UNIQUE FEATURES & SPECIFICATIONS

GENUINE MEDIFY TRUE HEPA H13 FILTRATION SYSTEM

- **TRUE HEPA H13 FILTRATION**

Removes up to 99.9% of airborne particles as small as 0.1 microns, such as allergens, pollen, dust, germs, pet dander, odors, mold spores, and smoke from air that passes through the filter.

- **CARBON ODOR FILTRATION**

Reduces household odors and VOCs (volatile organic compounds)/gases as shown by independent laboratory testing.

- **PRE-FILTER**

Captures large particles.

3 SPEEDS

Low, medium, and high speeds.

REPLACE FILTER INDICATOR

Illuminates when it is time to replace the filter.

FILTER PURIFICATION

1. PRE FILTER

Removes hair, fibers, and large particles like dander.

2. TRUE HEPA H13 FILTER

The high-efficiency H13 TRUE HEPA filter is tested to removed 99.9% of particles down to 0.1 microns. This higher grade of HEPA filter easily catches pollen, dust mites, and other tiny airborne particles you can't see.

3. ACTIVATED CARBON FILTER

Substantial carbon filter with carbon pellets remove toxic odors, smoke, and formaldehyde.

1. PREFILTER

catches large particles
like hair and dust

2. TRUE HEPA H13 FILTER

catches 99% of particles to 0.1
microns including pet dander
and pollen

3. ACTIVATED CARBON FILTER

absorbs and eliminates odors

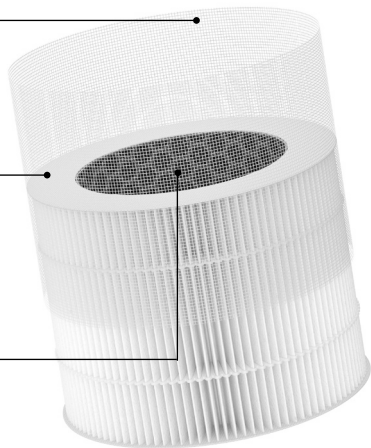

TECHNICAL DATA

- Voltage: 110-120 V AC 60 Hz
- Rated power: 35 W
- Noise level: <59 dB(a)
- Room size: up to 140 sq. ft.
- Unit dimensions: 11.2"H x 8.4"W x 8.4"D
- Unit weight: 5.3 lbs.

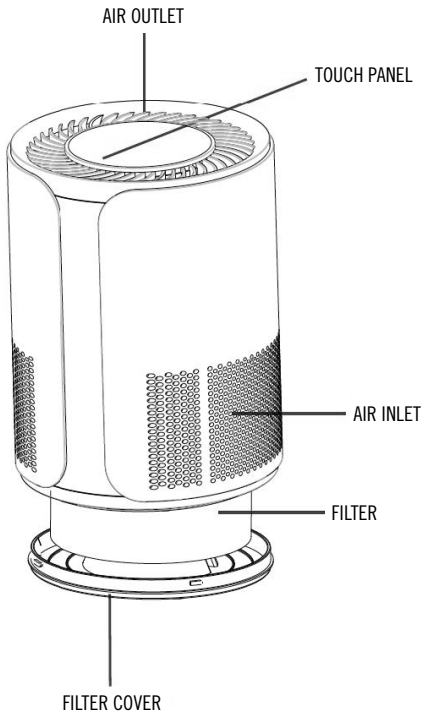

CONTROL PANEL



FILTER REPLACEMENT INDICATOR



NEGATIVE ION SWITCH

3

HIGH SPEED INDICATOR

2

MEDIUM SPEED INDICATOR

1

LOW SPEED INDICATOR



POWER ON/OFF

HOW TO USE

POWER ON/OFF

In standby mode, tap the “Power ON/OFF” button and the unit will turn on. To resume standby mode, hold down this button for 3 seconds.

FAN SPEED ADJUSTMENT

Once unit is turned on, the fan speed will default to low. To control fan speed, press “Power ON/OFF” button again. Each time this button is tapped, the fan speed will cycle through the following: low speed, medium speed, high speed, low speed, etc.

NEGATIVE ION SWITCH

Press to turn on the negative ion function. Press again to turn off this function.

FILTER INSTALLATION

INSTALLING FILTER SET

All filters must be used together. Do not disassemble filter set.

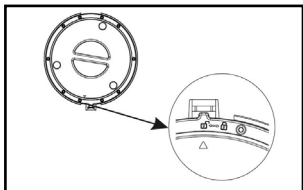

1. Remove filter cover at the bottom of the air inlet. Press firmly and turn left in the direction indicated by the arrow to remove the bottom cover.

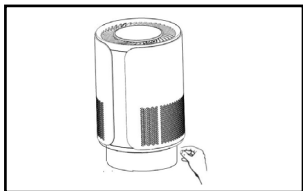

2. Remove the filter, which is enclosed in the plastic bag.

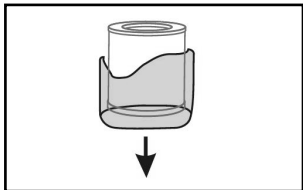

3. Remove the plastic bag.

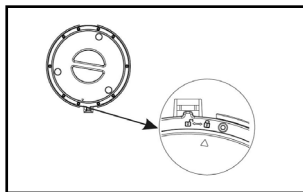

4. Re-insert the filter. Re-attach the filter cover and turn right to lock it in place.

FILTER REPLACEMENT

FILTER REPLACEMENT INDICATOR

This monitors the filter and notifies you when the filter must be replaced. When this light turns on, please turn off the unit and replace the filter. After replacement is complete, press and hold the Reset button for 3 seconds. The unit will beep, the filter replacement sensor will reset, and the reminder light will turn off.

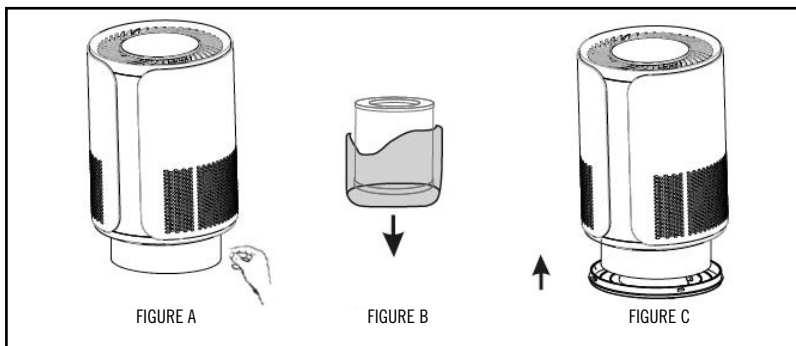

1. Take the filter out from the air purifier, as shown in Figure A.
2. Remove the packing bag of the new filter, as shown in Figure B.
3. Put the new filter inside the air purifier and reconnect the bottom cover, as shown in Figure C.
4. Plug in the power cord and turn on the air purifier.
5. Press and hold the Filter Replacement Indicator button for 3 seconds. The filter reset indicator light will turn off. This means the unit is successfully reset. The unit will begin counting down from 2,000 hours.

ATTENTION



Please remove all packaging on the filters before use.

Do not use the air purifier without filters.

When replacing the filter, you must reset the filter replacement indicator.

To purchase genuine Medify replacement filters, visit www.medifyair.com.

CLEANING AND MAINTENANCE

Please make sure to pull out the power plug before cleaning the unit. Do not immerse machine in water or any other liquid. Do not use abrasive, corrosive or flammable products to clean any parts of the unit. The unit uses composite filters, so filters cannot be washed.

CLEANING THE AIR PURIFIER

Clean the air purifier regularly to prevent the dust accumulation.

1. Use soft and dry cloth to remove the dust from the air purifier.
2. Use soft and dry cloth to clean the outlet and inlet of the air purifier.

TROUBLESHOOTING

PROBLEM	POSSIBLE CAUSE	POSSIBLE SOLUTION
Unit will not operate	Filter cover not installed correctly	Remove bottom cover and re-install
	Bottom cover not locked in place	Check that the bottom cover is turned into locked position
	Power supply for plug	Pull out the plug and plug it back into unit
	Incorrect power plug or wire	Contact customer service
Fan does not work	Machine doesn't turn on	Plug it in and turn it on
	Motor is not working	Contact customer service
	Machine on uneven ground	Move it to even and flat ground
	Loose or foreign particles inside	Contact customer service
	Filter packaging is not removed	Remove plastic covering from filters
	Motor is loose	Contact customer service
Performance issues	The filter needs to be replaced	Replace the filter with genuine Medify Air replacement filters for best performance
	Air intake or outlet is blocked	Contact customer service
	Filter packaging not removed	Remove the packaging from filters
	Not enough space surrounding the unit	Ensure 10-inches distance between sides of air intake and that distance to air outlet is not less than 8 in.
	Lack of filter or filter is not properly installed	Make sure all filters are placed in the order in accordance with instructions
	Coverage area questions	Check whether room area surpasses coverage area estimates

WARRANTY INFORMATION

If you have any additional questions, please contact customer service. All names and trademarks are property of Medify Air. Our company reserves the right to change the product at any time, without prior notice, and the company has no obligation to adjust any products supplied earlier. Please refer to the detailed warranty terms below. To register for the lifetime warranty, please fill out the attached form and mail it to:

Medify Air

1325 SW 30th, Avenue
Deerfield Beach, FL 33442

Or complete the lifetime warranty registration available on our website (preferred method):

www.medifyair.com

LIFETIME WARRANTY

Medify guarantees your Medify Air Purifier to be free of defects in material or workmanship for a lifetime period, provided you have completed and returned your warranty registration to Medify Air within the first 30 days of purchase, and that the filters are replaced with original and genuine Medify Air replacement filters at least once every three to four (3-4) months or after 2,500 hours of use. Within the first 30 days, Medify Air will replace the defective unit at no charge to you and reimburse you for any shipping charges. After 30 days, Medify Air's obligation and liability under this Lifetime Warranty is dependent on your use of our genuine filters, purchased on our website or from our authorized resellers, which can be found on our website. Prohibited use beyond power. Can only use a 220v unit with a 220v power supply. Can only use a 110v unit with a 110v power supply. You can break or ruin the circuit boards if you plug a 110v plug into a 220v power supply.

Our Lifetime Warranty remains in effect as long as:

1. You submit your warranty registration to Medify Air within 30 days of purchase.
2. You change filters with genuine and original Medify Air replacement filters at least once every three to four (3-4) months or after 2,500 hours of use (whichever comes first).
3. You use a proper power supply based on voltage: 110-120 V (North America & Japan) or 220-240 V (all other regions).
4. There is no evidence of tampering, mishandling, neglect, accidental damage, modification, and/or repair done to the Medify Air purifier by anyone other than authorized Medify Air service personnel.
5. Your air purifier is operated in accordance with the provided instructions.

This Lifetime Warranty is provided by:

Medify Air

1325 SW 30th, Avenue
Deerfield Beach, FL 33442

www.medifyair.com
info@medifyair.com
(888) 258-1008