



EVOTECH®
P E R F O R M A N C E

Installation Instructions



BMW S1000 XR TAIL TIDY

Product Reference - 12717

Kit Contents

- | | |
|---|--|
| A 1 x Lock Mounting Bracket | H 2 x M6 Nyloc Nuts |
| B 1 x Indicator Mounting Bracket | I 2 x M6 - 35 Socket Button Heads |
| C 1 x Licence Plate Mount | J 2 x M6 - 16 Socket Button Heads |
| D 1 x Wiring Cover | K 2 x M6 - 10 Socket Button Heads |
| E 1 x Reflector and Bracket | L 2 x Plastic Bolts and Screws |
| F 1 x 4mm Lock Barrell Spacer | M 2 x 5mm Lock Barrell Spacers |
| G 1 x 1mm Lock Barrell Spacer | N 5 x Cable Ties |

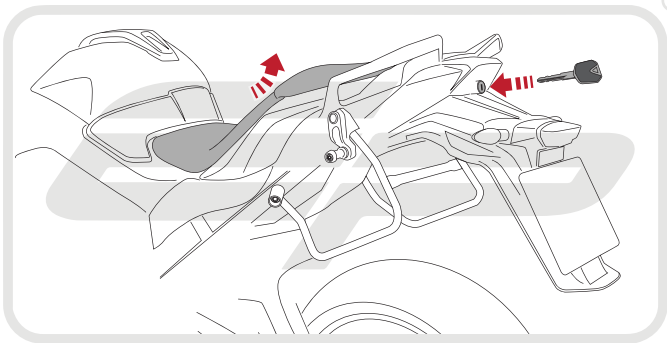

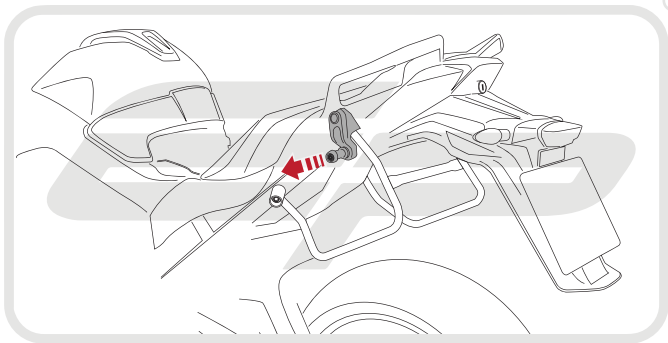

EVOTECH[®]
P E R F O R M A N C E

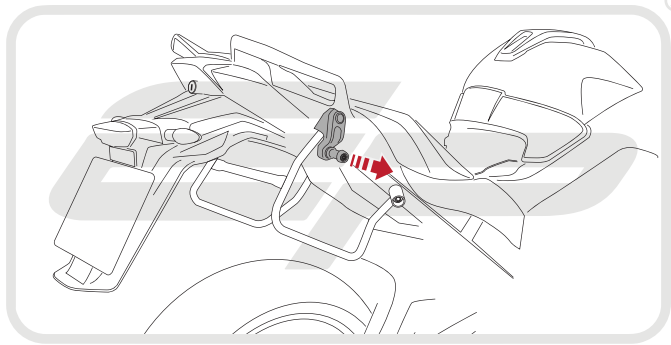

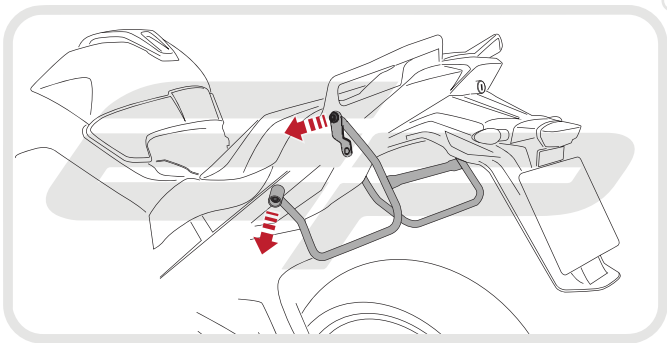

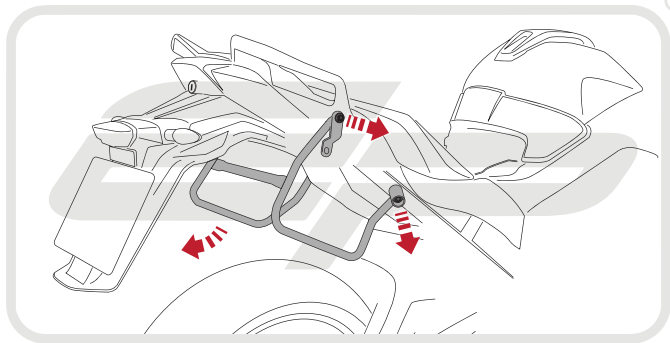

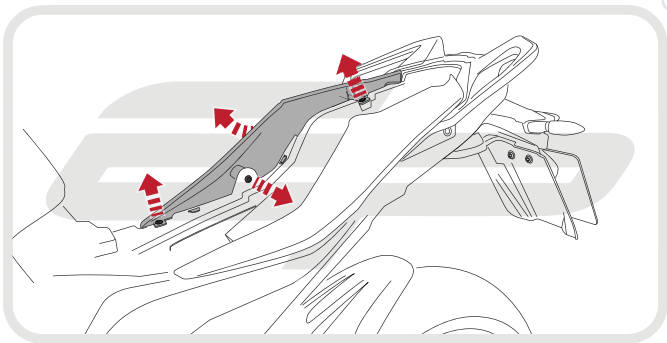

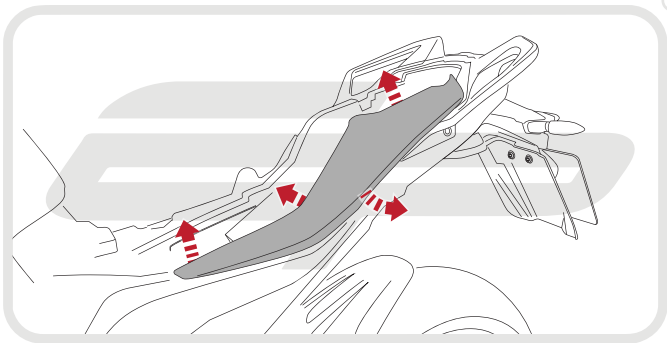

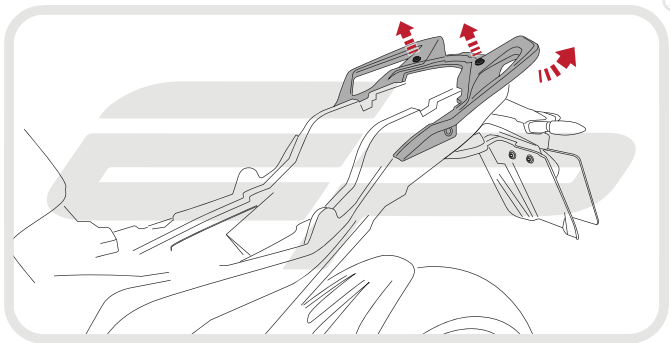

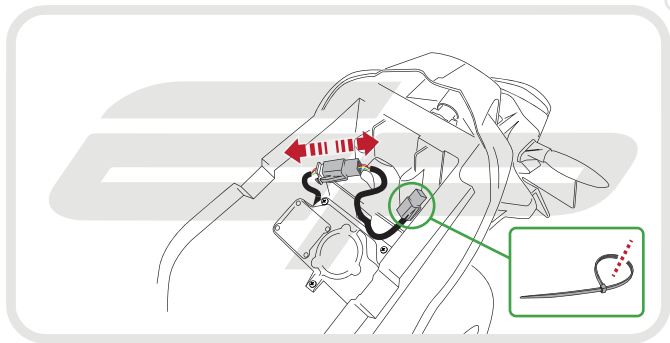



Caution

DO NOT remove unit.
Once fixings released, fold
unit down towards battery

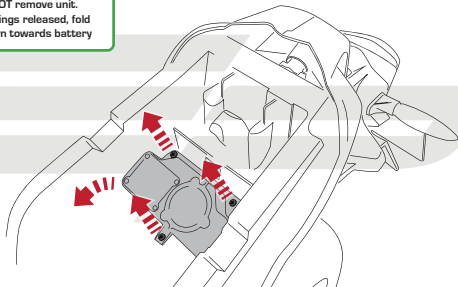

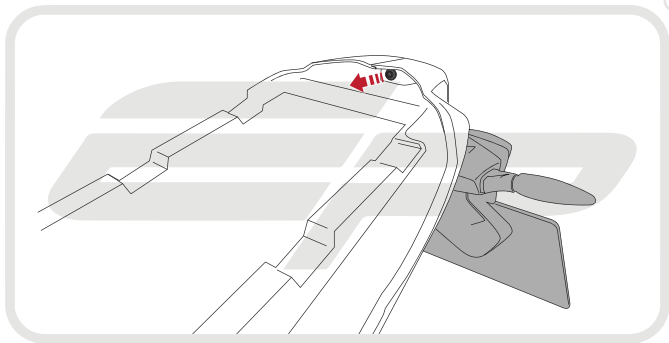

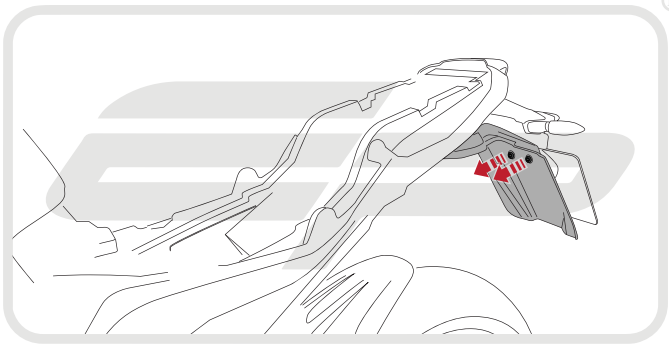

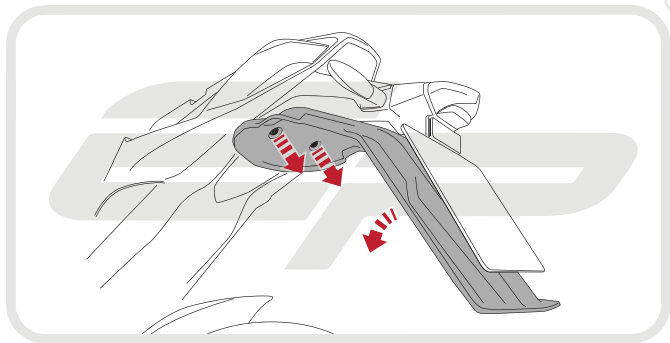

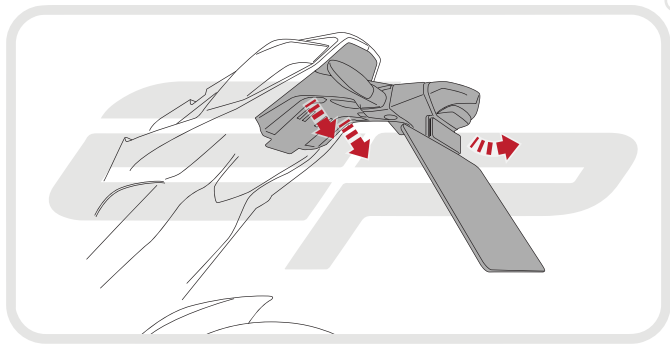

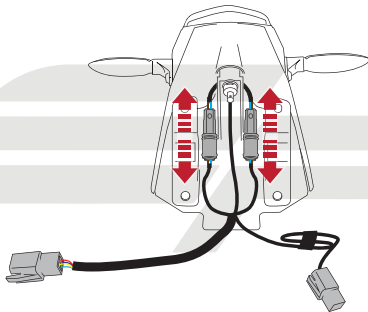

EVOTECH[®]
P E R F O R M A N C E

RELEASE



RE-SET

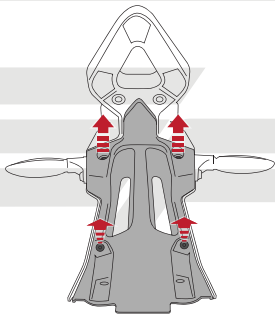

UNCLIP

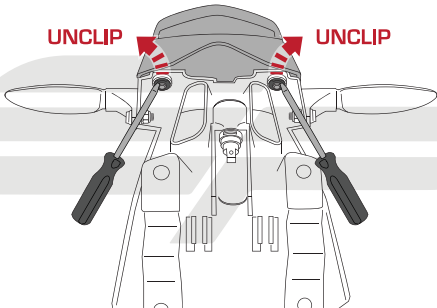

UNCLIP

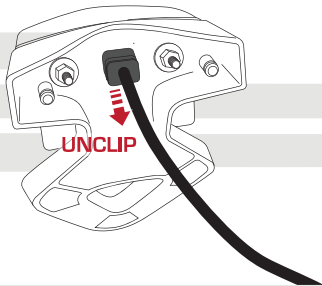

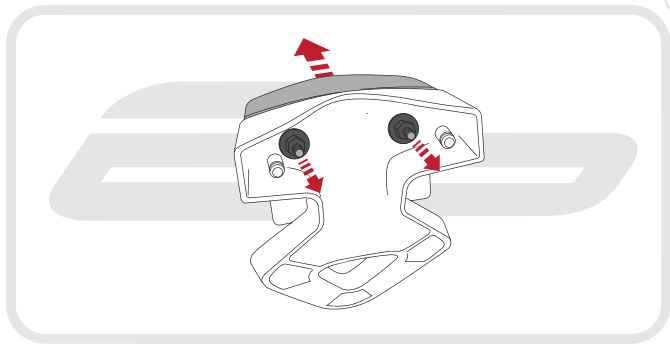

EVOTECH[®]
P E R F O R M A N C E

Twist indicator 90° and pull

Twist indicator 90° and pull

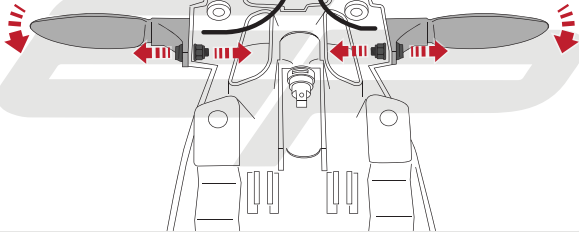

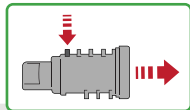
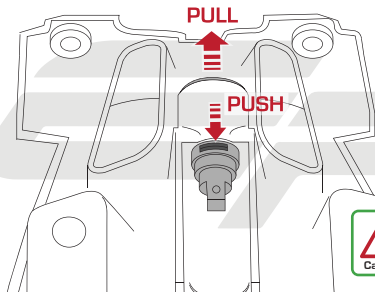

Caution

Suggest the key is inserted and the mechanism observed before removing lock

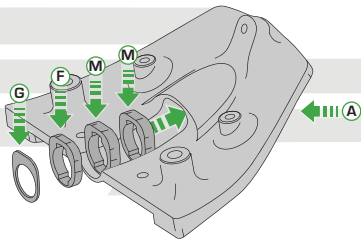

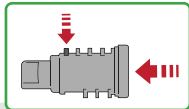
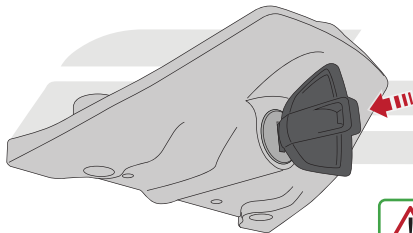

Caution

Insert key into lock barrel
to retract pins before
fitting it into the tail tidy

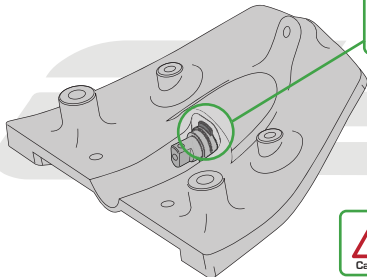

Caution

Ensure end pin extends past washers installed in stage 22



Caution

Check key can be inserted and rotated freely as in the original fender in stage 21



Insert and twist indicator 90°

Insert and twist indicator 90°

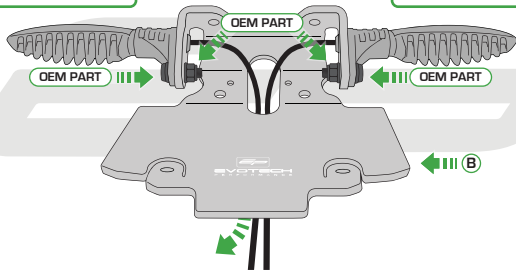

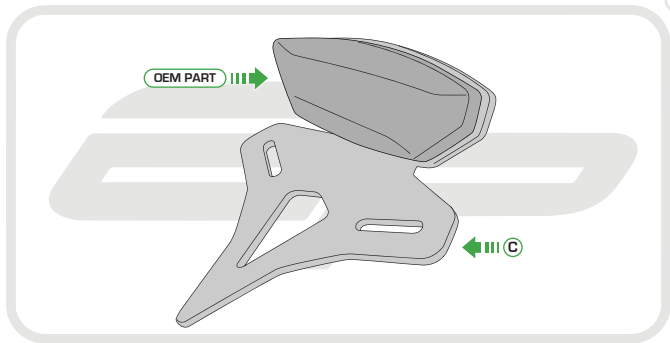

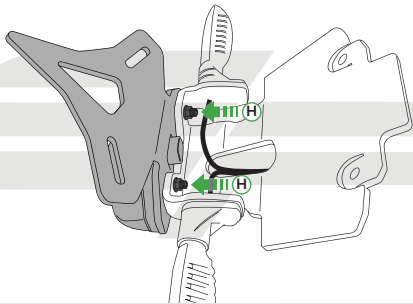

EVOTECH[®]
P E R F O R M A N C E

Plug in original wiring loom

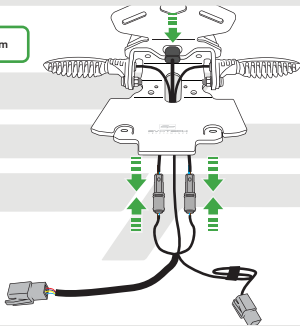

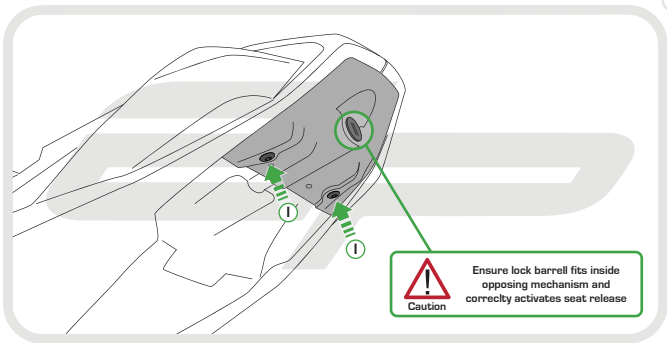

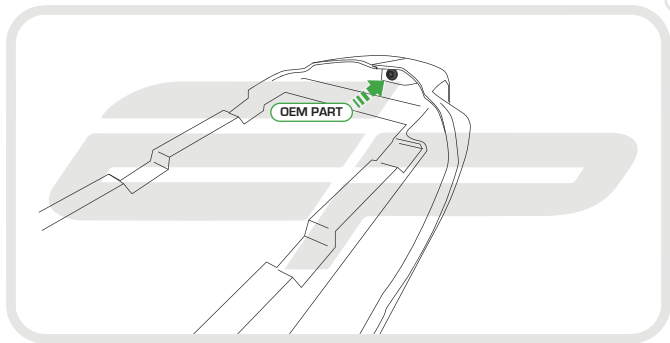

Feed wiring loom into bike

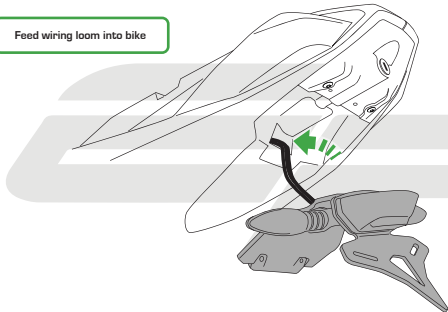

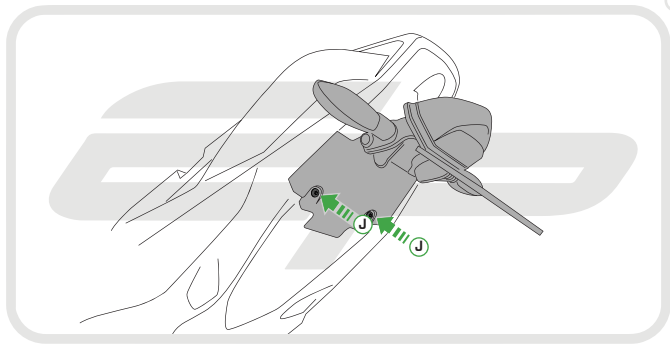

EVOTECH[®]
P E R F O R M A N C E

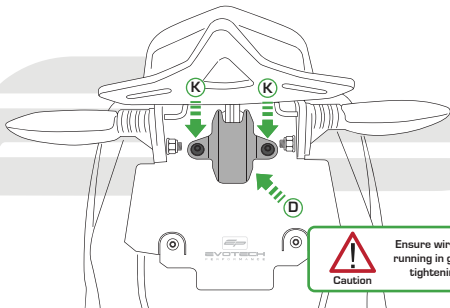

Caution

Ensure wires are neatly running in groove before tightening screws



Reverse Stages

10 - 1

Reflector Bracket Installation

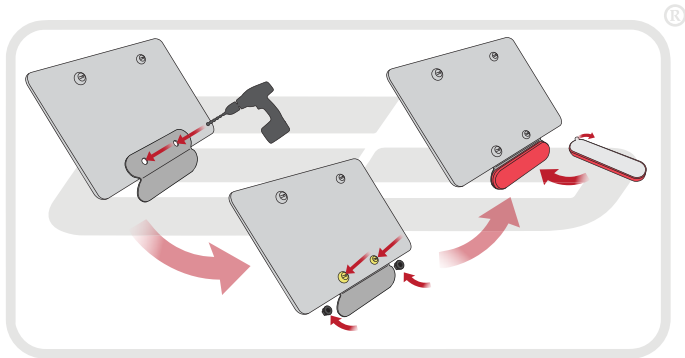

EVOTECH[®]
P E R F O R M A N C E



 **ESSENTIAL CHECKS** 

After installation of your tail tidy ensure that the licence plate does not contact the rear tyre when suspension is fully compressed.

Ensure all electrics including indicators, tail light, brake light and licence plate light lights are working correctly before riding the motorcycle.

It is recommended that periodic inspections are made to ensure that all fixings are fully tightend.



EVOTECH®
P E R F O R M A N C E

www.evotech-performance.com

