



EVOTECH®
P E R F O R M A N C E

Ducati Monster 821/1200

Installation Instructions



Kit Contents PRN011676 - Left Hand Protection

- (A) 1 x Bracket
- (B) 1 x Front Spacer (3 Grooves)
- (C) 1 x Rear Spacer (1 Grooves)
- (D) 1 x Bobbin Spacer
- (E) 1 x Bobbin Head
- (F) 1 x M12 Washer
- (G) 1 x Polyurathane Washer
- (H) 1 x M12 x 100 x 1.25 Caphead
- (I) 2 x M12 x 130 x 1.25 Caphead

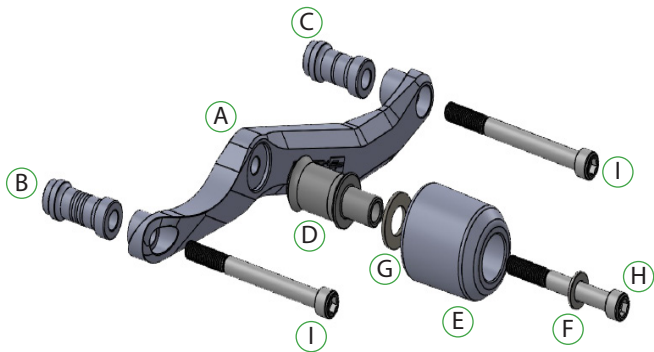

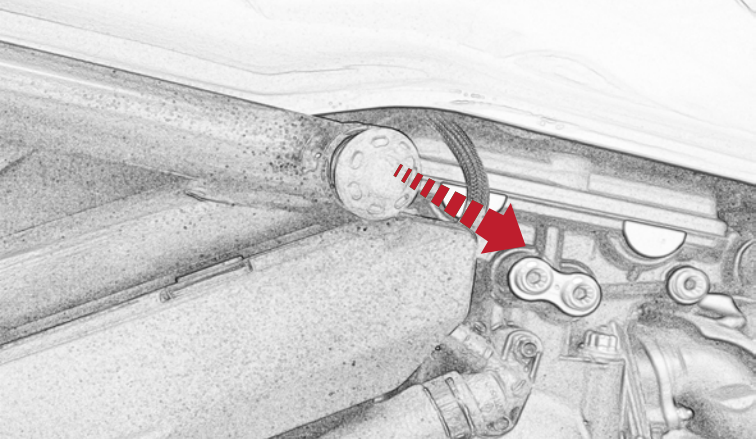

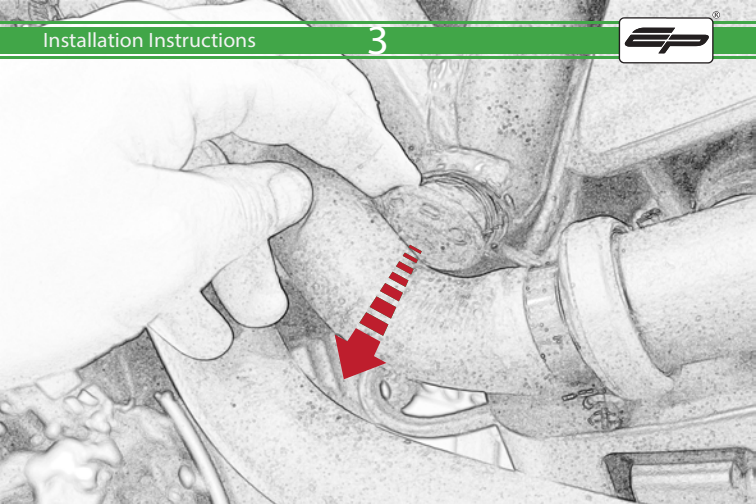

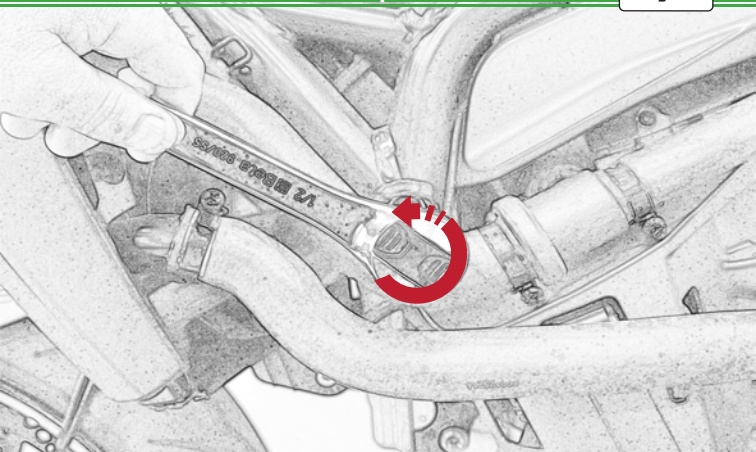

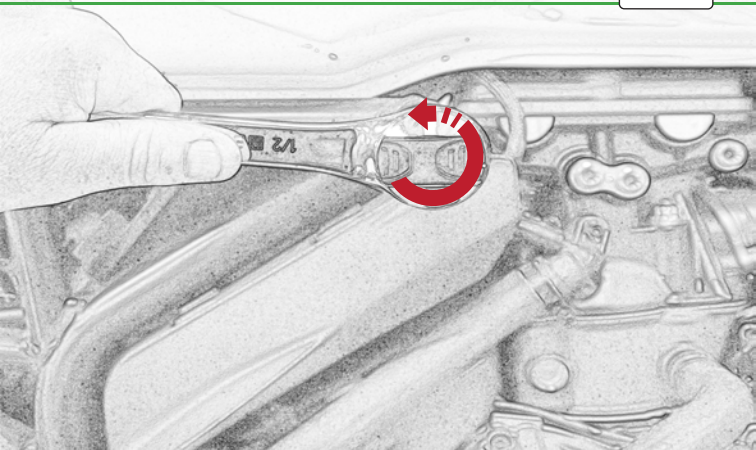

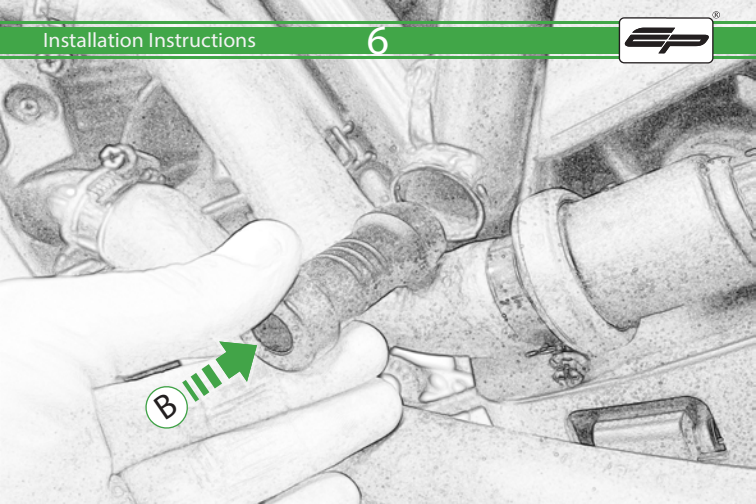

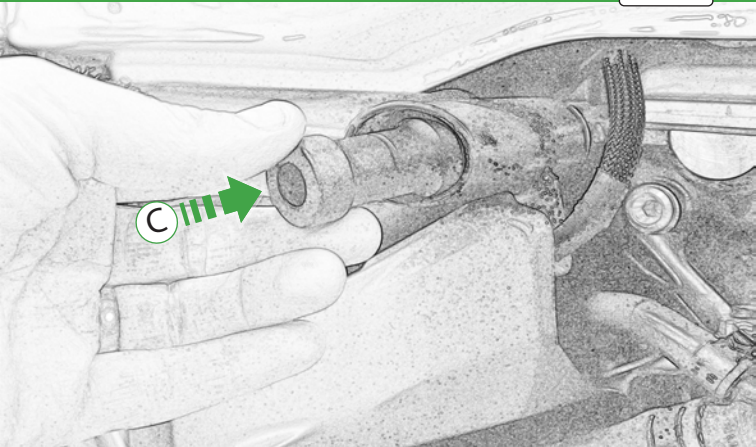

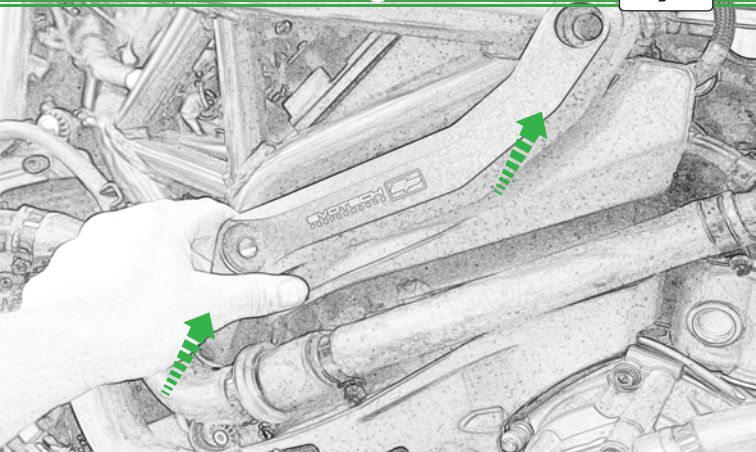

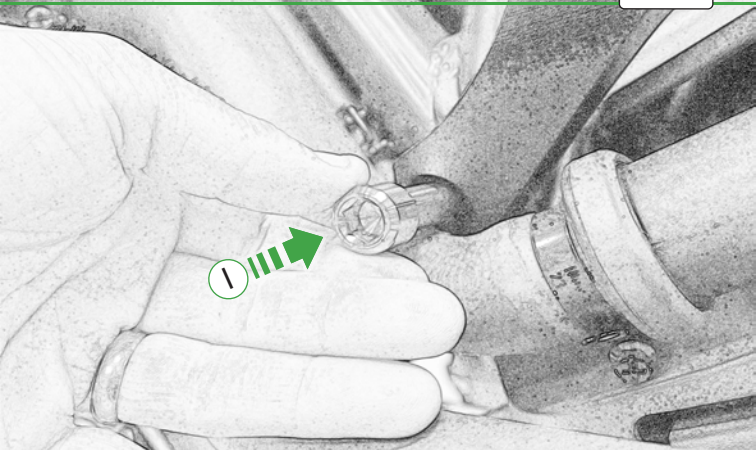



Fully Tighten
90Nm

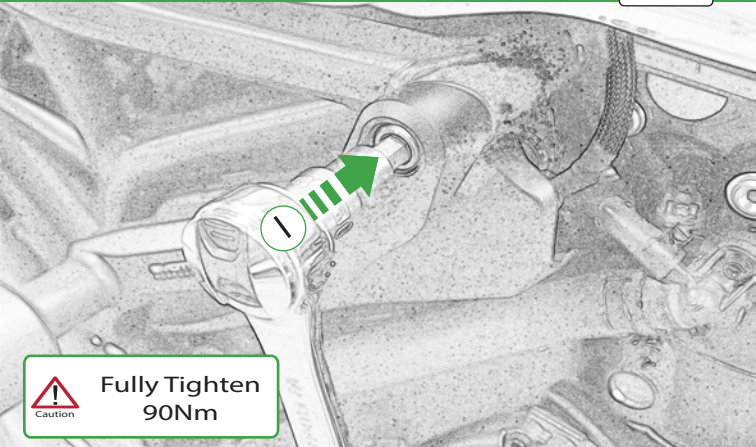

Fully Tighten
90Nm

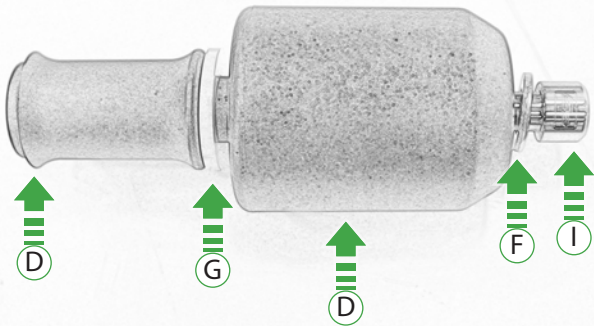





Fully Tighten
45Nm



Kit Contents PRN011676 - Right Hand Protection

- (A) 1 x Bracket
- (B) 1 x Front Spacer (No Grooves)
- (C) 1 x Rear Spacer (2 Grooves)
- (D) 1 x Bobbin Spacer
- (E) 1 x Bobbin Head
- (F) 1 x M12 Washer
- (G) 1 x Polyurathane Washer
- (H) 1 x M12 x 130 x 1.25 Caphead
- (I) 2 x M12 x 100 x 1.25 Caphead

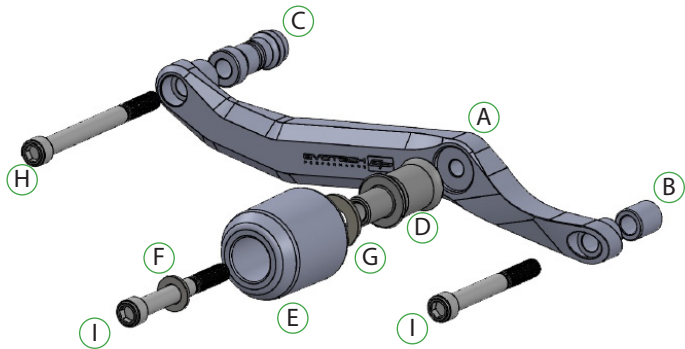

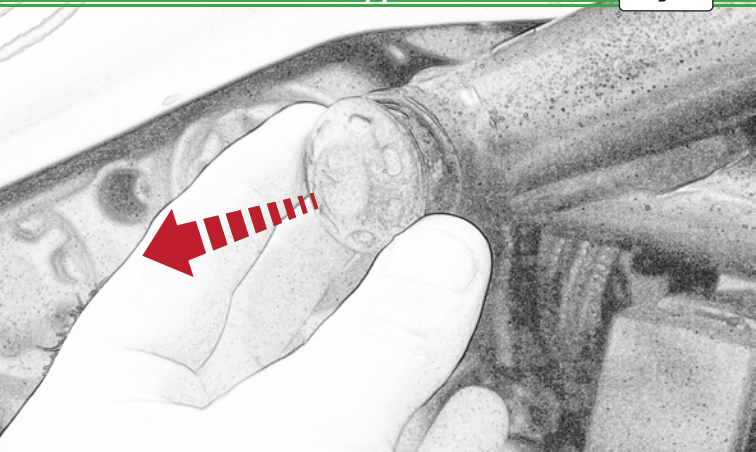





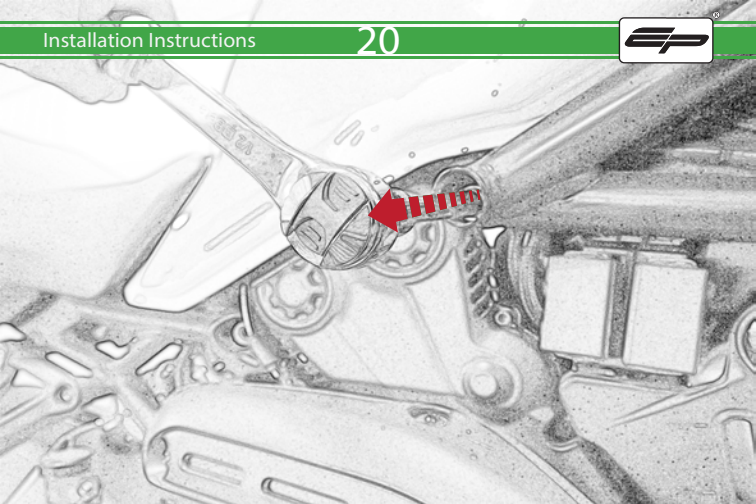

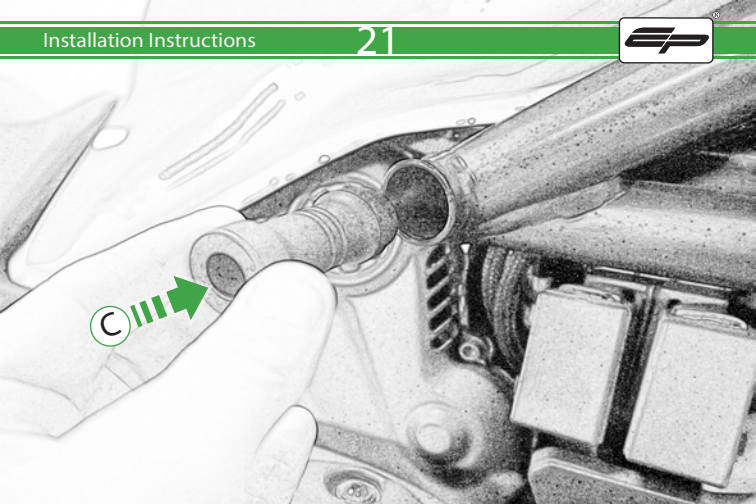

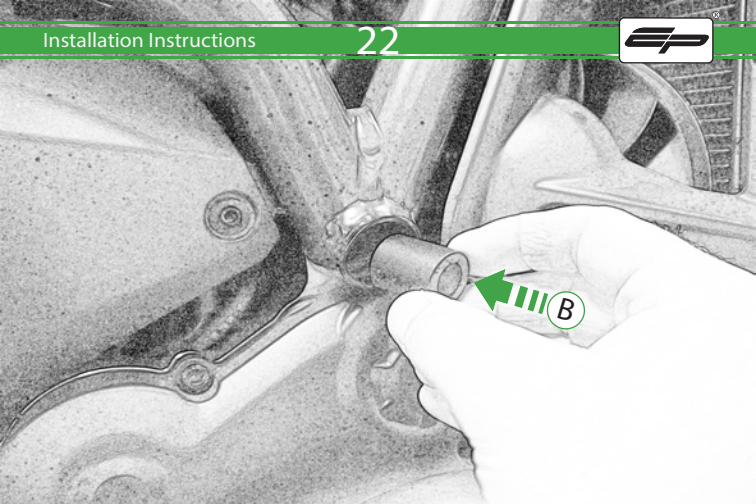

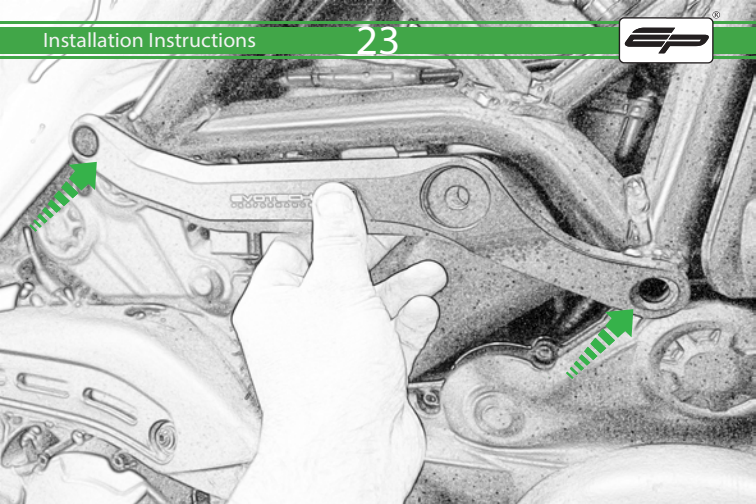





Fully Tighten
90Nm

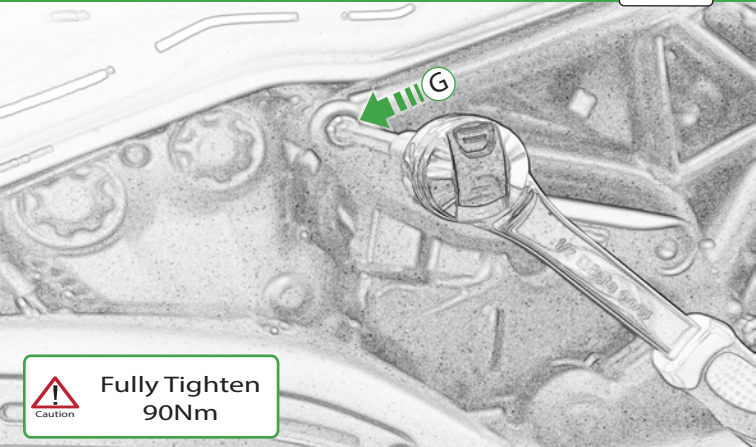

Caution

Fully Tighten
90Nm

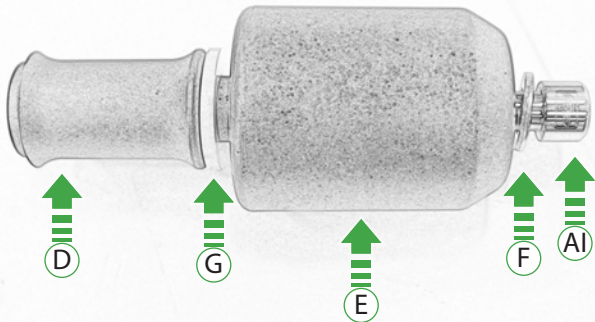



Fully Tighten
45Nm



 **ESSENTIAL CHECKS** 

It is recommended that periodic inspections are made to ensure that all bolts are tightened to the specified torque settings.

Should the bike be involved in an accident a thorough inspection should be made and any components that have taken an impact, no matter how small, be replaced



EVOTECH®
P E R F O R M A N C E

www.evotech-performance.com