



Instructions Manual

Distributor of SALUS Controls:
QL CONTROLS Sp. z o.o., Sp. k.
Rolna 4
43-262 Kobielice,
Poland
salus@salus-controls.pl



www.salus-controls.eu

SALUS Controls is a member of the Computime Group
Maintaining a policy of continuous product development SALUS Controls plc reserve the right to change specification, design and materials of products listed in this brochure without prior notice.



Issue Date: V 2020

Introduction

The FC600-M 0-10V module is dedicated to fan coils or trench heaters controlled by 0...10V signal. It is a supplement to the main thermostat SALUS FC600. The module smoothly adjust fan speed via controlling 0V...10V voltage. In addition, device can control two electric actuators (heating and cooling valve).

Principle of operation

The module recognizes input signals from SALUS FC600 for three different voltage fan levels and accordingly sets the 0V...10V output voltage.

Voltage values for each levels and time of voltage increase on output are settable by buttons and displayed on LCD. Settings are saved to the device memory. The module smoothly changes the voltage value at startup and during switching between fan speed mode.

Additionally this module recognizes the input signals for the heating valve and a cooling valve. Accordingly which signal will be received, module will send +24V voltage at the output for the heating/cooling valve.

Product Compliance

This product complies with essential requirements of the European Parliament Directive And Of The Council 2012/19 / EU of 4 July 2012 on waste electrical and electronic equipment (WEEE).

Safety Information

Use in accordance with national and local regulations of the country and in EU territory.

Indoor use only. Keep your equipment completely dry.

The installation must be carried out by a qualified person in accordance with the rules of the country and in the EU.

Before install, repair, maintenance or during any connection work disconnect power supply from the module and make sure the terminals and wires are free of voltage.

The electrical installation where module works should be secured with a fuse, specially selected to the applied loads.

The device can not be used with the damaged case.

Under no circumstances don't modify the module construction.

Do not allow access to the module to people who didn't read this manual.

Do not install the device under voltage.

A short circuit at the output may damage the unit.

It is forbidden to operate a defective device or repaired by unauthorized service.

Terminals description

Terminal Name	Function
+24V 0V ↓	Module power supply 24V DC
0V +24V ☀️ / ❄️	4 pipe: 230V AC control output - heating valve 2 pipe: 230V AC control output - heating / cooling valve
0V +24V ❄️	4 pipe: 230V AC control output - cooling valve 2 pipe: N/A
+24V 0V Y (0...10V) 🌀	Power supply and fan control 24V DC
F1	Fan Speed control (Low level) - 230V AC input
F2	Fan Speed control (Medium level) - 230V AC input
F3	Fan Speed control (High level) - 230V AC input
V1	4 pipe: 230V AC control input - heating valve 2 pipe: 230V AC control input - heating / cooling valve
V2	4 pipe: 230V AC control input - cooling valve 2 pipe: N/A
N	Neutral

Electrical diagram

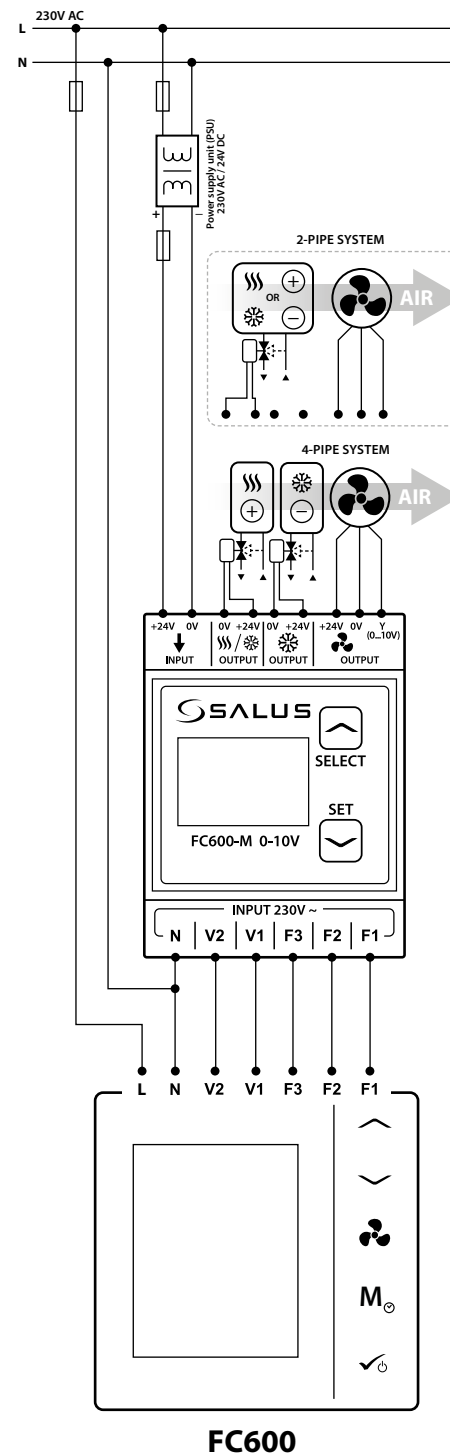

Display description and button functions

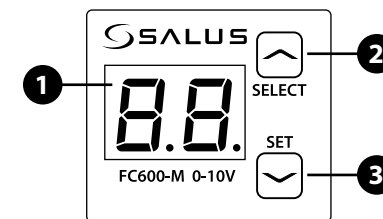

1. Double-digit, 7-segment LED display
- displays parameters: F1, F1, F3, t and voltage and time values
2. Entering the menu, selecting the parameter, increasing the value
3. Confirmation of parameter selection, reduce the value

DIN rail mounting

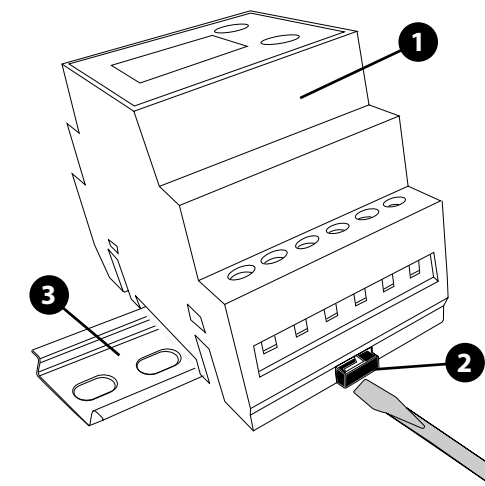

For module covering there is a special installation enclosure for the installation of electrical equipment. This enclosure should prevent user before access to the module wiring terminals. The module is designed to be mounted on a standard 35mm DIN rail. Before sliding the module 1 onto the DIN rail 3, slide the hook 2 using the flat screwdriver. When module is mounted on the rail, place the hooks at the original position. Make sure that module is mounted solidly and that it can not be removed from the rail without a tool.

NOTE: The connection wires should be protected against tearing, loosening, or built up in such a way that they can not be exposed to mechanical stress.

Setting voltage thresholds for fan speed

1

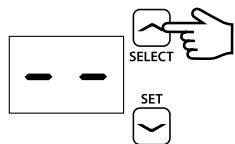

Press button to enter menu

2

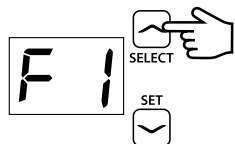

Using button select the appropriate parameter to set:

F1 - for the first voltage threshold

F2 - for the second voltage threshold

F3 - for the third voltage threshold

3

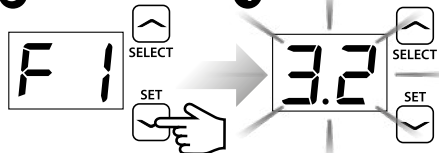

Press button to confirm your option.

Display will flash voltage value for the selected program. Set the target value by using button or .

4

NOTE: Module starts to supply voltage at the output when any threshold is selected. The current value change causes a fan speed change - this allows you to check its operation and select adequate speed.

The voltage threshold settings are limited by the module:

F1 - range from 0V to setpoint in F2

F2 - range from the setpoint in F1 to the setpoint in F3

F3 - range from setpoint in F2 to 10V

The total voltage value for the F1-F3 thresholds is limited to 0...10V range.

5

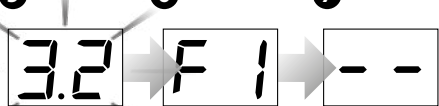

Wait 8 seconds - the module will save settings.

6

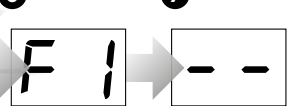

After saving device will automatically return to the menu.

7

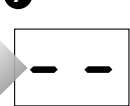

After 15 seconds inactivity, the module will go into sleep mode.

Setting the increase/decrease time of the output voltage

Time of voltage increase at the output when module starts-up and switches voltage thresholds is expressed by the parameter t. This parameter is limited to the range from 0 to 50 s.

The module provides a smooth voltage increase at the output for thresholds depending on t parameter, according to the following characteristic.

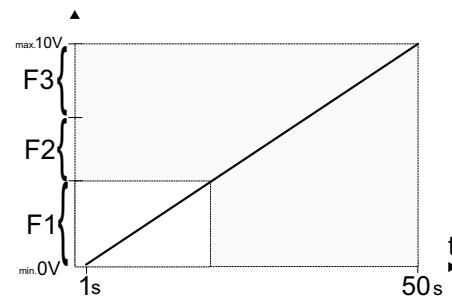

1

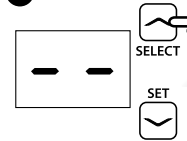

Press button to enter menu.

2

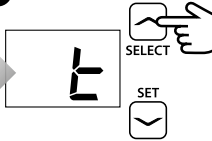

Select the t parameter by using button.

3

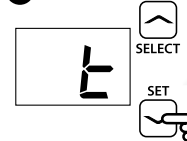

Press button to confirm your option.

4

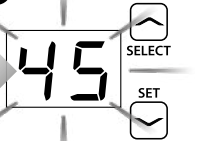

On display will flash time value. Set the target value using button or .

5



Wait 8 seconds - the module will save settings.

6

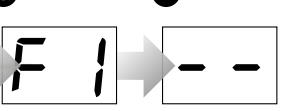

After saving device will automatically return to the menu.

7

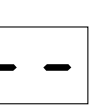

After 15 seconds inactivity, the module will go into sleep mode.

Replacing the fuse

A fuse is located inside the device casing. It protects module and the devices connected to it.

NOTE: Before opening the casing disconnect the power supply from the terminals of FC600-M 0-10V module and FC600 controller.

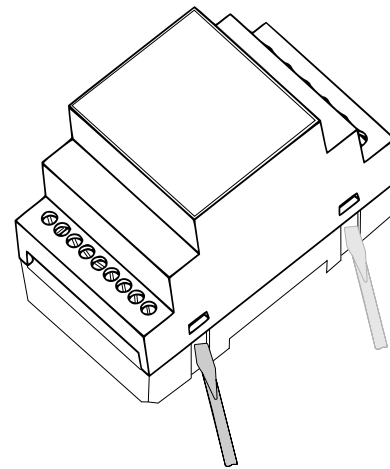

To open the casing of the module, you need to pry all the hooks (with a flat screwdriver) and then carefully remove its upper part.

NOTE: In the module should be used porcelain, slow blow 5x20 mm fuses with nominal burnout current of 8A / 230V.

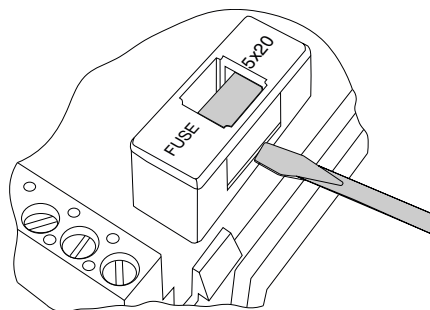

Using a flat screwdriver, pry the fuse holder, replace the fuse, put the holder back in place and then snap the upper housing of the module.

Product Specification

Power supply	24V DC
Max current consumption	8A
Input voltage signals	230V AC
Output signals:	
-	1(1)A, 24V DC
-	1(1)A, 24V DC
- fan	6,5(6,5)A, 24V DC
Fan control	0...10V
Mounting type	DIN rail 35mm
Protection degree	IP20 (build over)
Operating temperature	from -10°C to 40°C
Storage temperature	from -10°C to 65°C
Relative humidity	5-85% without steam condensation
Display	Double-digit, 7-segment LED display
Wires gauge	0,5 - 2,5 mm ²
Length of uninsulated wire	7 mm
Weight	60 g
Standards	PN-EN 60730-2-1 PN-EN 60730-1
Protection class	II
Overvoltage class	II
Pollution degree	2
Dimensions [mm]	65 x 90 x 52

