



1955-1956 & 1957
Chevrolet Bel Air
Installation Guide

WARNING



Please read and understand this manual before installing your EPAS kit.

The installation of this system should be done by a professional mechanic or a very knowledgeable amateur. You will be cutting and splicing your steering column, therefore EPAS Performance will not be held responsible for any malpractice. Caution should be taken when installing the electric motor: no impacts, shocks or hammering should be done to the unit. For aesthetic reason, you may choose to paint the assembly either in black or the color of your steering column to conserve the original look.

For a complete understanding, we strongly suggest to read this owner's manual prior to any installation.

Should you have any questions or concerns feel free to contact us at (941) 893-5427 or visit our website for installation videos.

EPAS Performance wishes you thousands of enjoyable miles with your new Electric Power Steering!



Required tools:

- Drill
- Right angle grinder, with cutting disc
- Eye protection
- Measuring tape
- Steering wheel removal tool
- You will also need hand tools to remove the steering column

Chevrolet Bel Air 1955-1956 & 1957



Motor Orientation Diagram

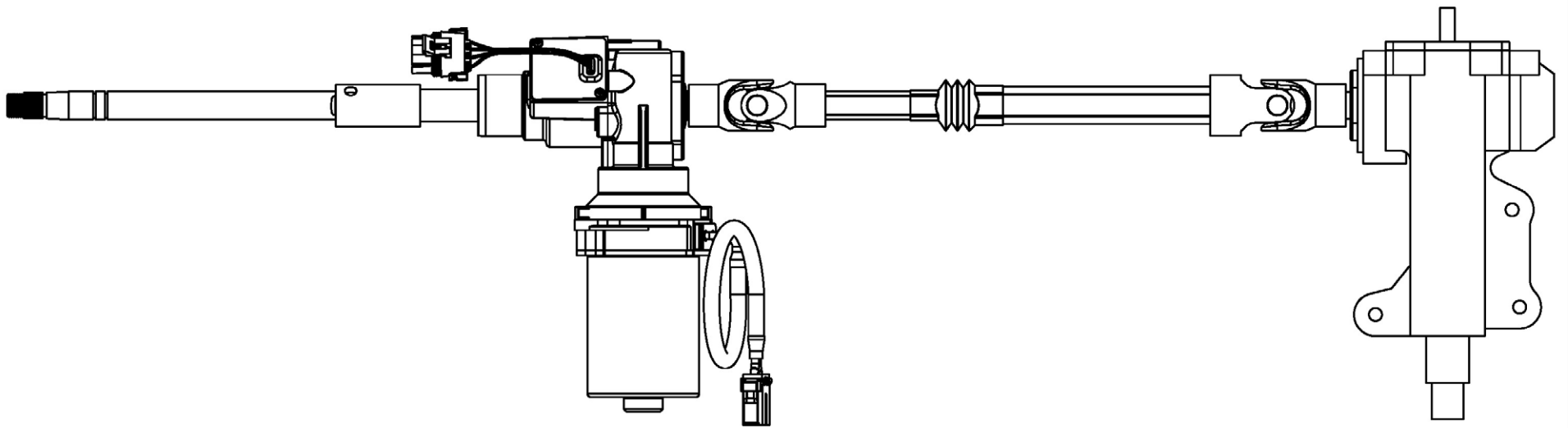



Remove Column Assembly:

Unplug the wiring harness from the vehicle. Remove the turn signal wiring bracket. Remove any bolts securing the steering column bracket to the dash. Remove any bolts holding the steering column and floor seal in place. Pull the steering column free.

The steering wheel can be removed before column disassembly if you require additional space to maneuver the column during removal.

Remove any wiring in the column or other inner parts to avoid damaging them when cutting. Do not remove the steering shaft.

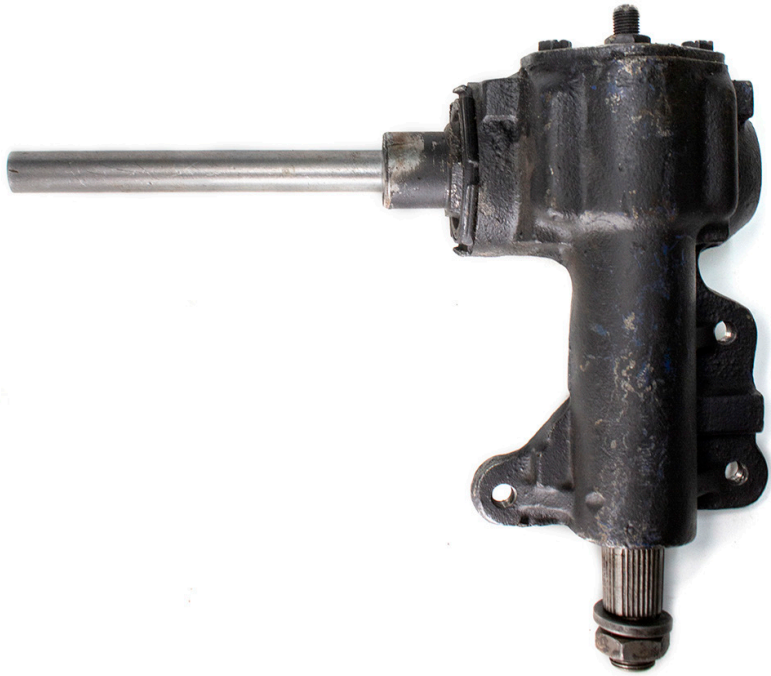
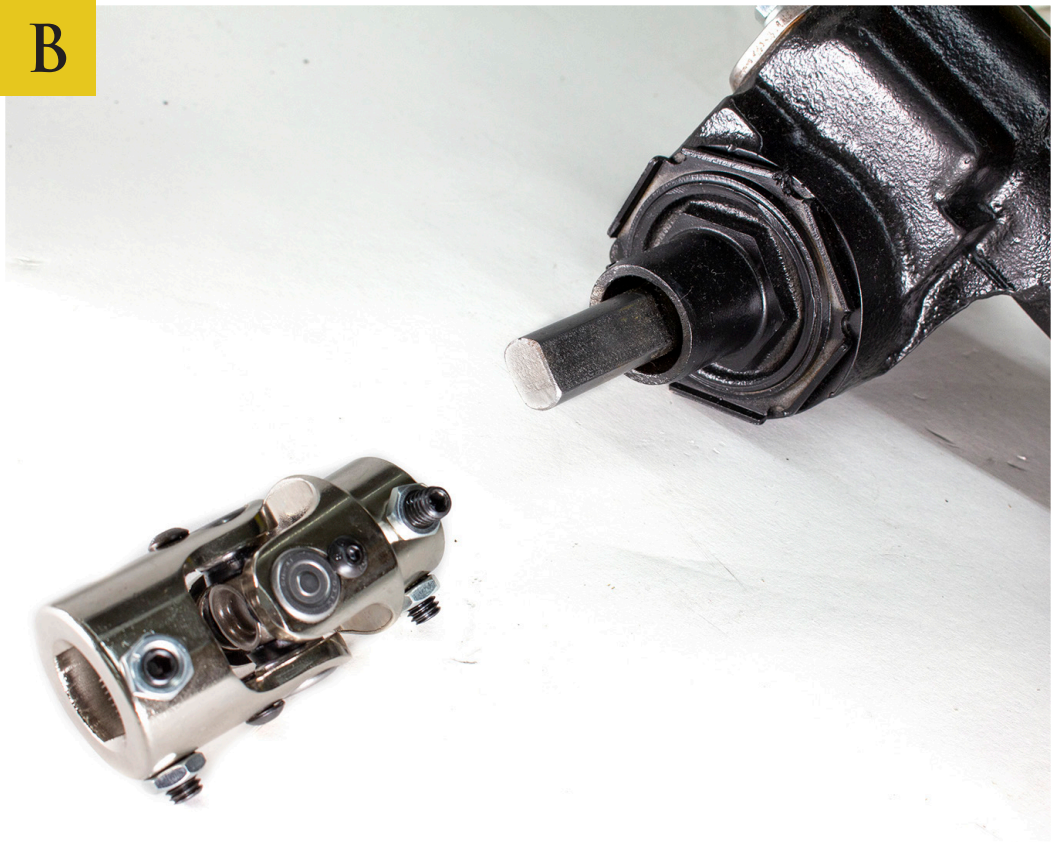
A**B**

Steering Box Modifications:

Once the column tube is free, cut the steering shaft at the firewall (engine bay side) to allow easy removal of the steering box. The rest of the steering shaft will be replaced by the provided shaft in your EPAS Performance kit. OEM Steering shaft can be discarded.

You will need to mill 0.105" from both sides of the shaft closest to the steering box housing to create a 2" long $\frac{3}{4}$ " DD section. Once the shaft has been modified you can cut it to its final length of 1 $\frac{1}{2}$ ".

Once the shaft has been modified the steering box can be reinstalled in the vehicle.

Connect the supplied U-Joint to the end of the steering box shaft.

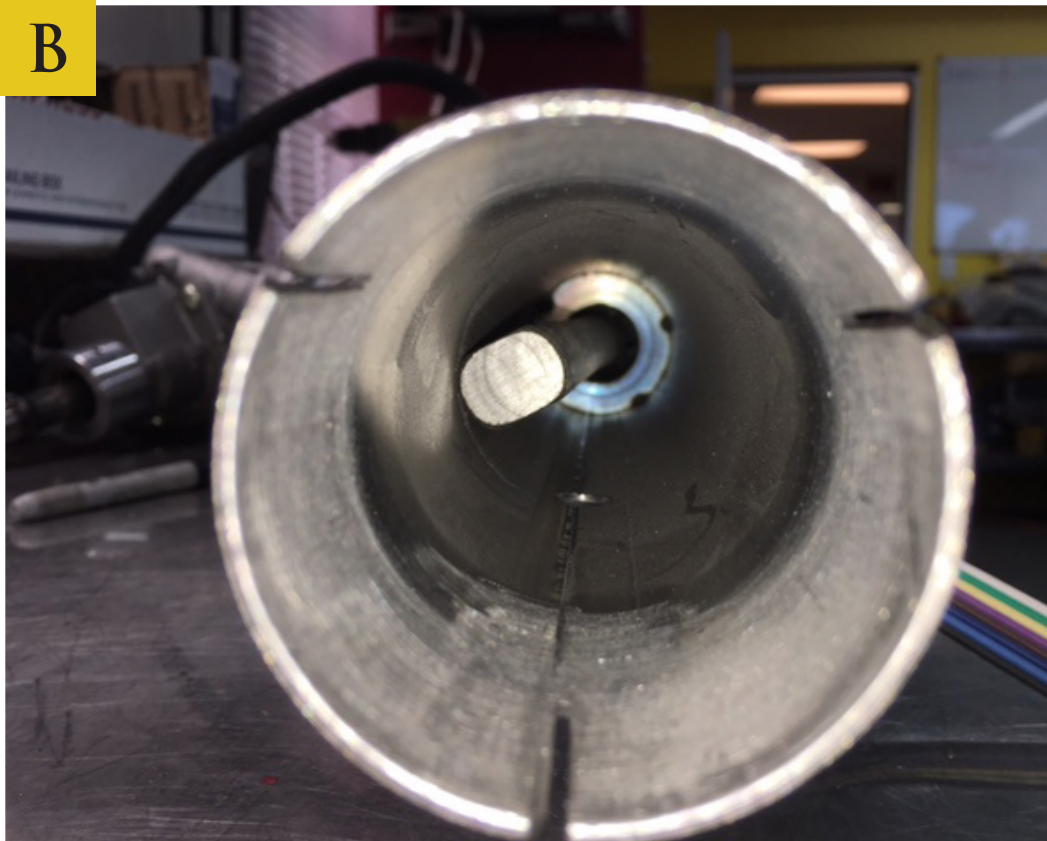

Column & Shaft Modifications:

Disassemble the column (leaving the steering shaft). On the column tube, measuring from the bottom lip of the bell housing, make a cut at $11 \frac{1}{4}$ " (measurement of 1955-1956) (On 1957 the measurement will be 11".)

After making the initial cut remove the steering shaft from the column. The steering shaft will need to be cut measuring 4" from the first cut end. A $\frac{3}{4}$ " DD will then need to be made $1 \frac{1}{4}$ " long (to create the $\frac{3}{4}$ " DD, follow the same steps as on the steering box modifications page).

A $\frac{1}{2}$ " hole will need to be drilled on the column, measuring from the cut end upwards at $4 \frac{5}{8}$ " in order to access the set screw on the motor shaft. On the cut end, 3 slices will need to be made at equal placement, 1" up from the cut end. Place clamp loose on the column.

Once all column modifications are complete place the provided column clamp on the end of the column. Reassemble the column and reconnect the inner wiring harness.



Bearing Plate Assembly:

**Plate style and shape will vary per application*

For kits that include a firewall plate, align them so that they match the images shown. Be sure the three bolts holding the bearing in place are loose to allow the bearing to pivot inside of the flanges. This will allow you to achieve the required angle of the collapsible shaft to align with the steering box (mounting flanges may have to be separated for bearing to pivot).

Make sure to tighten all bolts once all parts are aligned.

A



Firewall Plate Installation:

Use the OEM bolts that held the original floor seal to fasten the replacement firewall plate provided in the EPAS kit.

The bearing on the firewall plate should face the engine bay side.

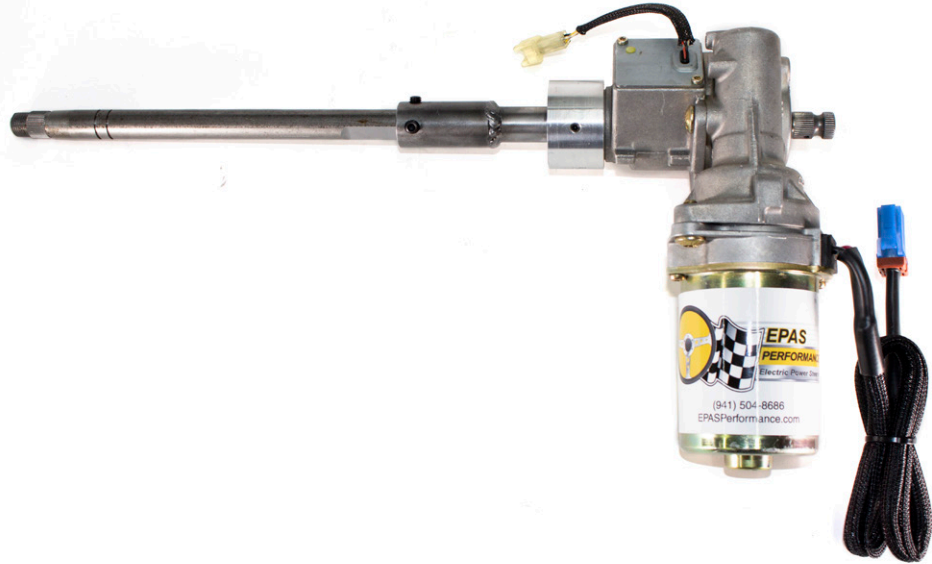
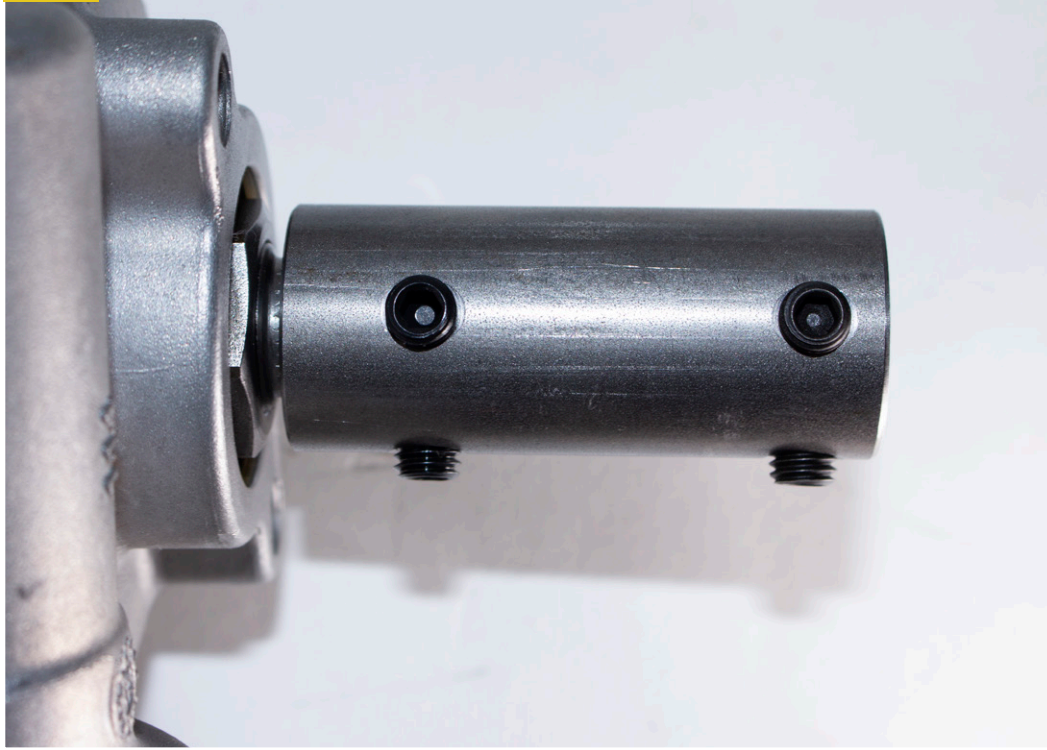
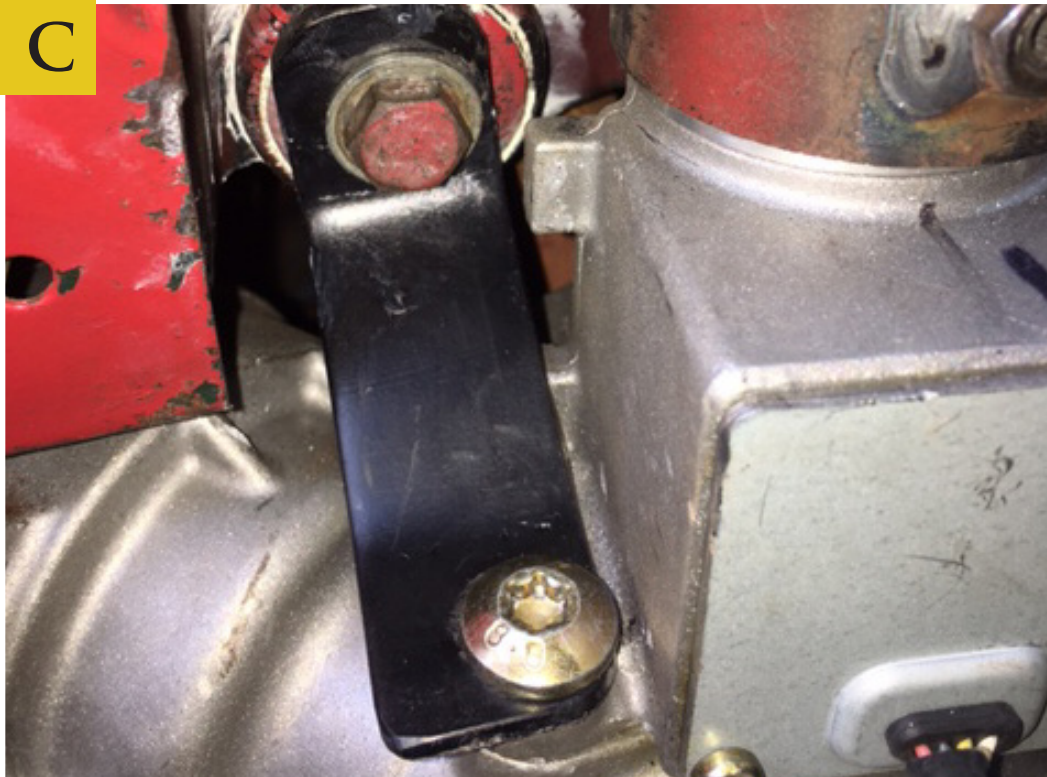
A**B****C**

Column and Motor Assembly:

Begin assembly by installing your cut steering shaft into the EPAS motor. Once the shaft is fully seated, tighten and locktite the set screws on the motor coupler.

Place the provided coupler on the splined end of the motor and tighten the set screws to fix it in place.

Once fully assembled, the motor and column assembly can be placed into the vehicle and fixed in place using the OEM or supplied (year dependent) column bracket.

1957 Bracket install- use the 5/16" bolt attached to the EPAS motor as shown below. The top portion of the bracket will use a stock bolt that should line up when motor is clocked.

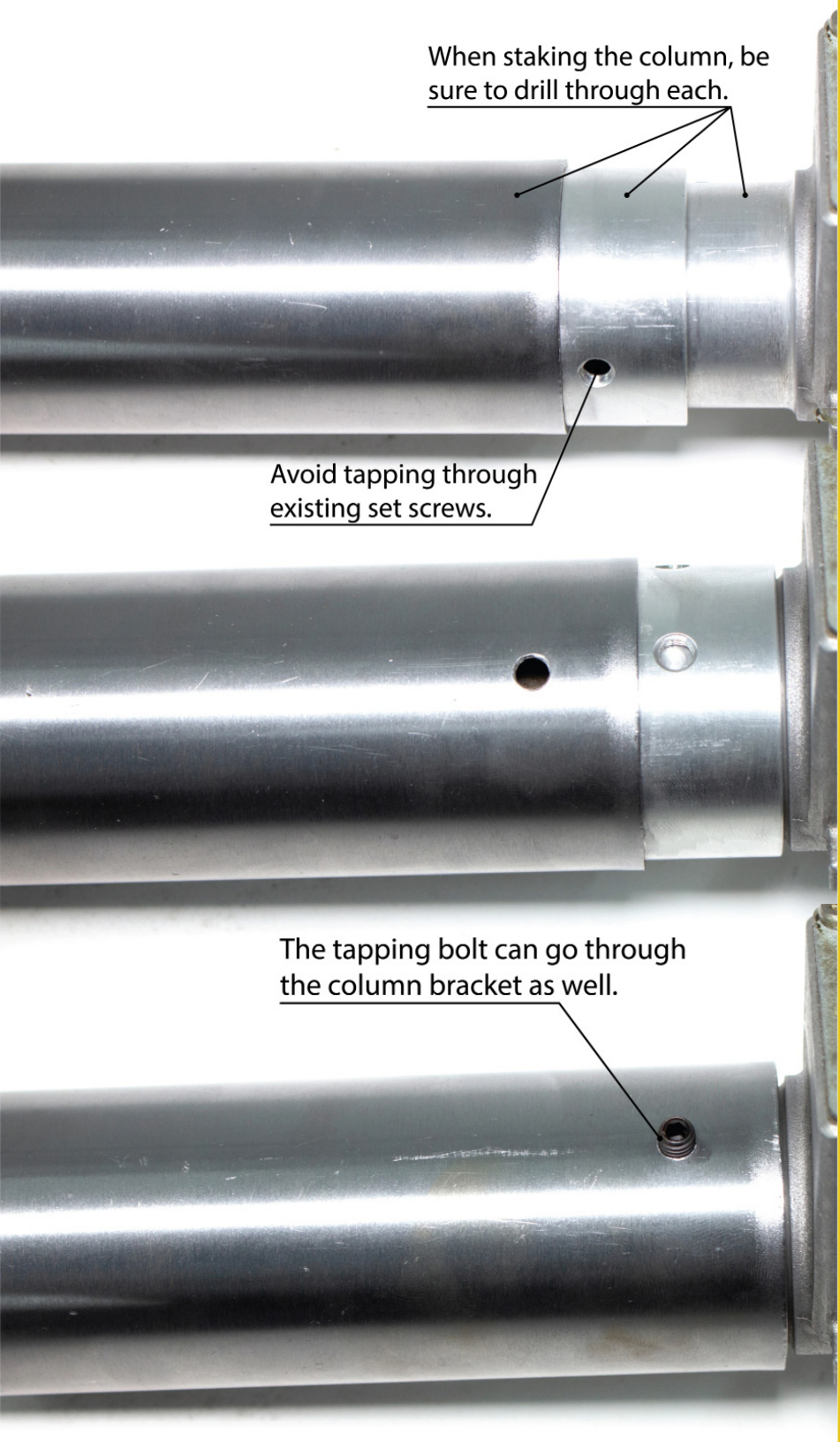

When staking the column, be sure to drill through each.

Avoid tapping through existing set screws.

The tapping bolt can go through the column bracket as well.

STAKING COLUMN:

For added stability, the column tube and motor housing can be “staked” in place to reduce the possibility of the system spinning in the vehicle. This process is suggested but not required.

To begin the staking process you will first need to clock the motor to the correct position and mark the column. Once the steering column is in place, the motor should sit between 9 and 11 O’clock position. The motor has 360° clockability to allow for an adjustable fit if the suggested position does not work.

Drill a hole through the column tube and the aluminum collar (attached to the motor) tapping the motor housing. (“Tapping” the motor housing is making a dent in the housing to ensure the bolt being used will rest in the dent) Stake the column in place using ¼-20 bolt to “sandwich” all three together.

Ensure the screw length is no more than 10mm, if it is too long it can bind the shaft. You can drill through the motor housing for additional security (**BE SURE NOT TO DRILL OR TAP INTO THE MOTOR SHAFT**).

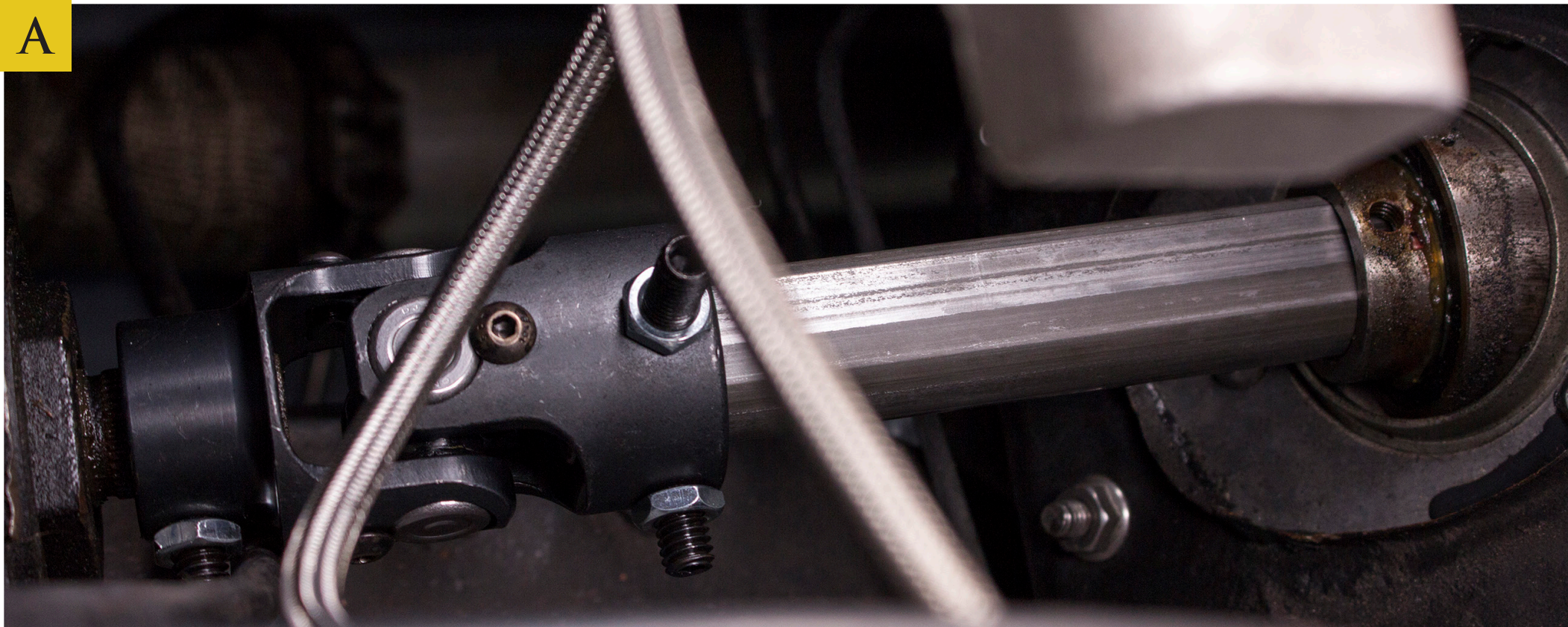

Lower Portion Installation:

Place the provided U-Joint on the steering box. Pull the 1"DD shaft of the provided collapsible lower portion through the firewall bearing and fit the 3/4"DD shaft into the U-Joint on the rear of the motor.

Make sure to tighten all bolts and set screws once the parts are aligned. Ensure set screws are seated properly to prevent binding.

Some U-Joint manufacturers may provide one longer set screw. This set screw does not need to be shortened and can be used as provided.

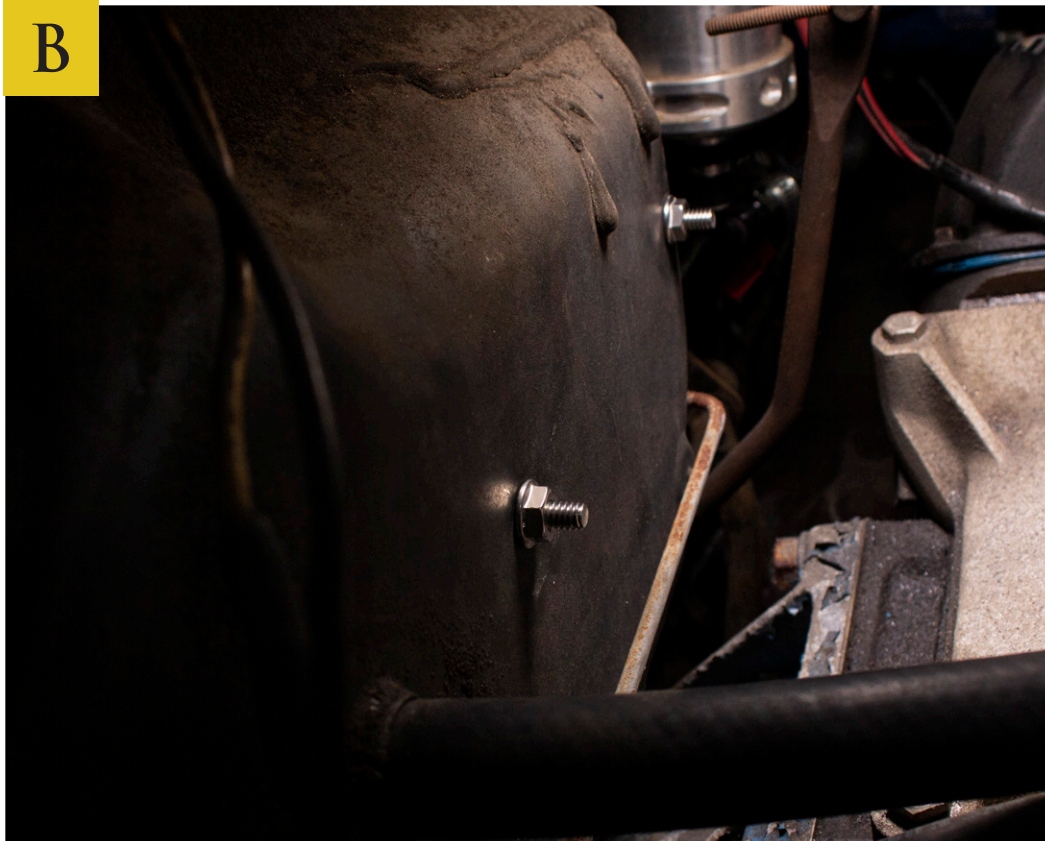

Control Module Installation:

Install the pre-wired control module and its wiring. Location inside the vehicle is at builders discretion.

Ensure both ground wires are properly connected to the module plate before mounting.

Connect the plug from the motor (**Blue Connector**) to the module. Connect the plug for the torque sensor (**4way**) to the module.

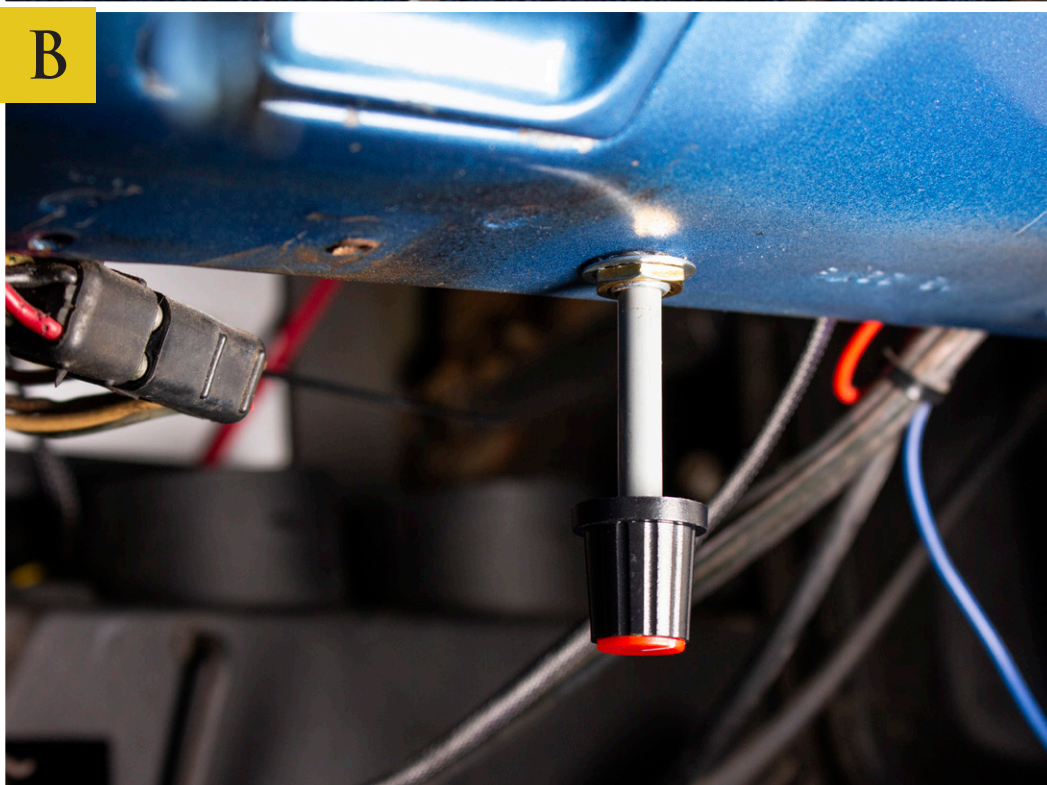

Power Wires & Potentiometer Installation:

Reconnect the column wiring harness to the vehicle.

Hook up the small red wire to a hot in run and the #10 red wire directly to your battery or a direct power source.

Install potentiometer in an accessible location.

This potentiometer allows you to adjust the strength of the assistance provided by the system. When turned fully clockwise the system will be set to maximum. Turning the dial counter clockwise will reduce the amount of assistance until none is being provided. Your steering will have returned to its original resistance (the system will not be completely powered down until the vehicle itself is turned off).

Module Wiring Diagram

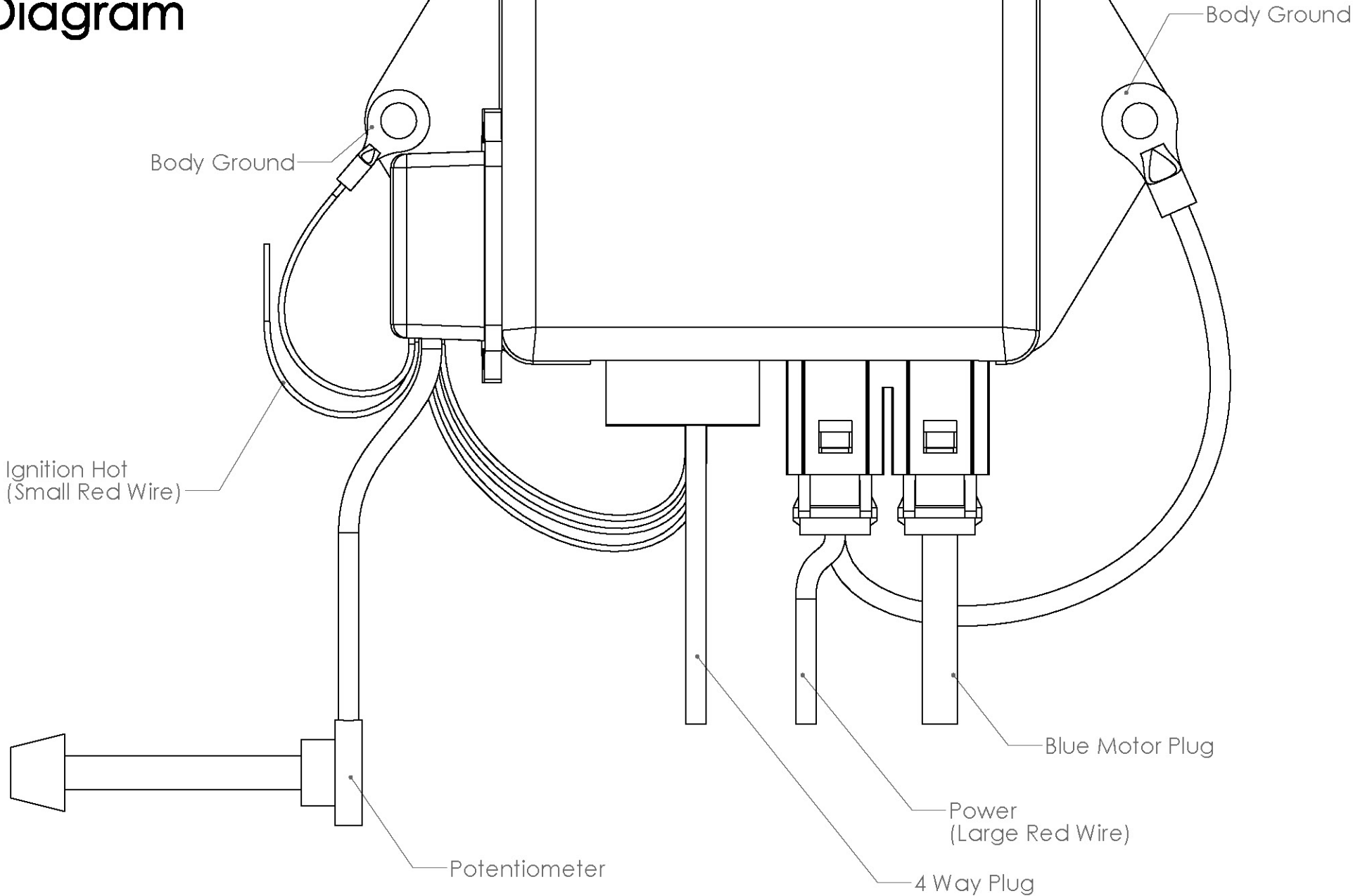

TERMS AND CONDITIONS

LIABILITY LIMITATION AND RELEASE

We are pleased you have chosen to purchase one of our automotive specialty equipment items. Our products are carefully designed to combine performance, durability and safety, and to work in concert with the vehicle's original equipment. As they are specialty products, however, and as both performance and safety are paramount concerns, we urge our customers to consider having the products professionally installed.

We caution the purchaser that the enhancement provided by the specialty equipment item may change the handling characteristics of the vehicle. We urge the purchaser to carefully familiarize him/herself with the vehicle's performance characteristics with the new equipment. This should be done in a safe environment and in a safe manner.

We have no control over the quality or correctness of equipment installations performed by others, nor can we control the uses (in manner or environment) products are subjected to. Accordingly, liability on the part of EPAS Performance LLC is limited to the terms of its Express Limited Warranty.

A decision by the purchaser to retain and install the item purchased will be deemed acceptance of the specific terms of this Liability Limitation and Release.

The purchaser expressly releases and waives any claim against us for any consequential damages or injury that may arise from the use, or any malfunction, of its product. This Liability Limitation and Release binds the original purchaser, all successors in interest, and all persons to whom the product may subsequently be transferred; and the purchaser agrees to make this limitation known to all such persons. This Liability Limitation and Release is part of the consideration for the sale of the product.

This Liability Limitation and Release is governed by the laws of the State of Florida, United States of America. Any dispute regarding its terms or application is subject to arbitration in the State of Florida at the request of either party to the sale.

WARRANTY

This warranty is limited to the repair or replacement of the defective part only; the warranty specifically excludes labor or consequential damages or injury. The decision as to whether the defective part will be repaired or replaced will rest solely with the manufacturer. The warranty period begins on the date the product is shipped to you.

Full 5-year warranty nontransferable.

This warranty is void if the product is or was improperly installed, abused in any manner. Road or accident damage is not covered.

To make a claim under this warranty, call EPAS Performance to return the defective product, shipping or postage prepaid. Please include a copy of the original purchase invoice and a note describing the circumstances of the failure or malfunction.

This warranty is governed by the laws of the State of Florida, United States of America. Any dispute regarding the coverage of this warranty, its application or terms is subject to arbitration in the State of Florida.

If the purchaser disagrees with any of the terms of this warranty, please return the purchased item within three (3) business days of receipt. A decision by the purchaser to retain and install the item purchased will be deemed acceptance of the specific terms of this warranty.

1/16/2020

**Thank you for purchasing the EPAS Performance electric power system.
We do hope you enjoy your vehicle for many miles to come.**

