



1957 Ford Thunderbird

Installation Guide

Applies to 1955-'56 Ford Thunderbird
(2" shorter column)

Table of Contents

- Required tools
- Kit contents
- Motor Orientation Diagram
- Steering column and wheel removal
- Steering column modifications
 - disassembly
 - cut lengths
- Column and motor reassembly
- Steering box reinstallation
- Steering wheel and column installation
- Column staking guide
- Module and potentiometer installation
- Wiring diagram
- Warranty and product disclaimer

WARNING



Please read and understand this manual before installing your EPAS kit.

The installation of this system should be done by a professional mechanic or a very knowledgeable amateur. You will be cutting and splicing your steering column, therefore EPAS Performance will not be held responsible for any malpractice. Caution should be taken when installing the electric motor: no impacts, shocks or hammering should be done to the unit. For aesthetic reason, you may choose to paint the assembly either in black or the color of your steering column to conserve the original look.

For a complete understanding, we strongly suggest to read this owner's manual prior to any installation.

Should you have any questions or concerns feel free to contact us at (941) 893-5427 or visit our website for installation videos.

EPAS Performance wishes you thousands of enjoyable miles with your new Electric Power Steering!



Required tools:

- Drill
- Right angle grinder, with cutting disc
- Eye protection
- Measuring tape
- Steering wheel removal tool
- You will also need hand tools to remove the steering column

Ford Thunderbird

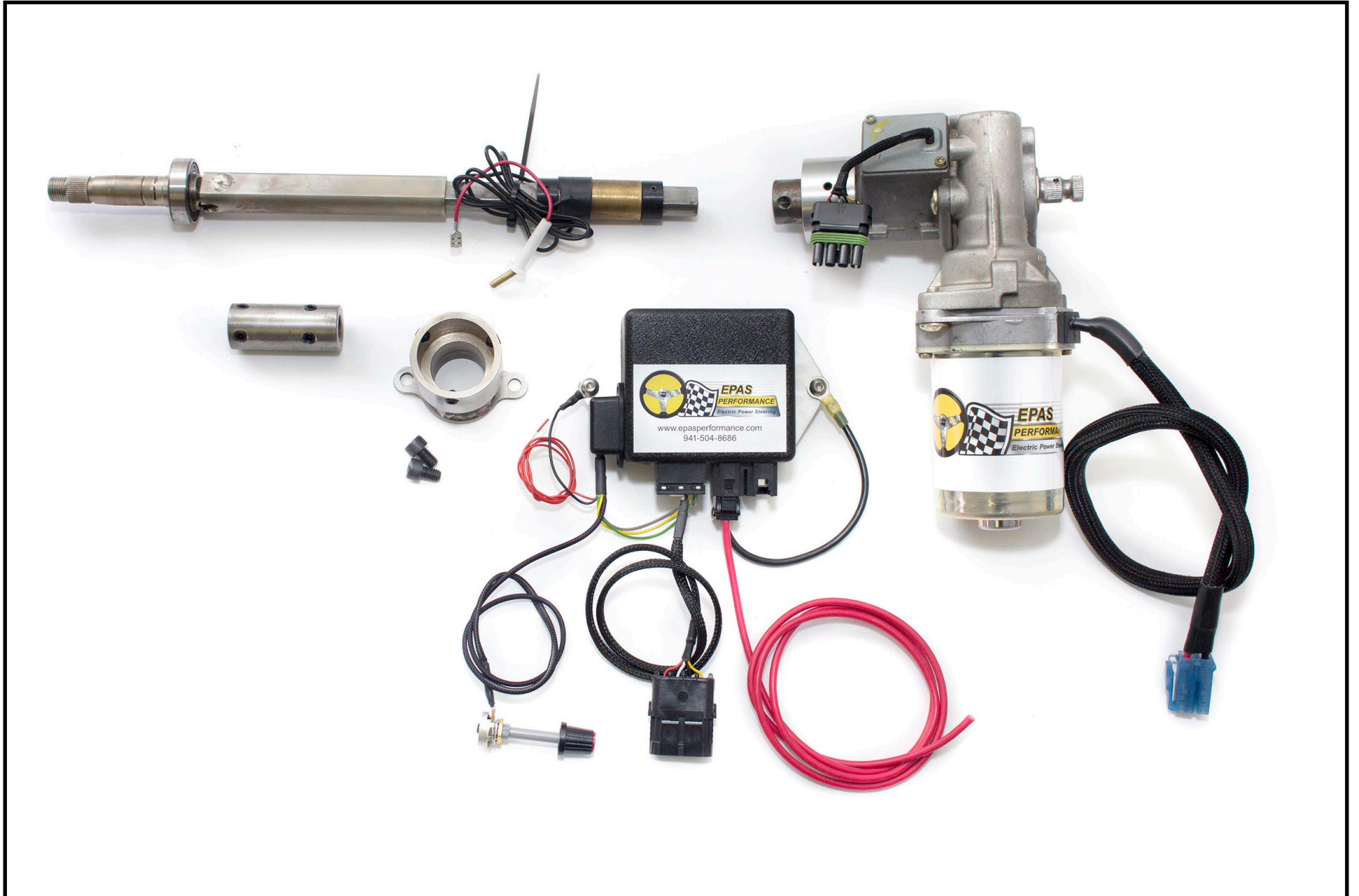

Motor Orientation Diagram

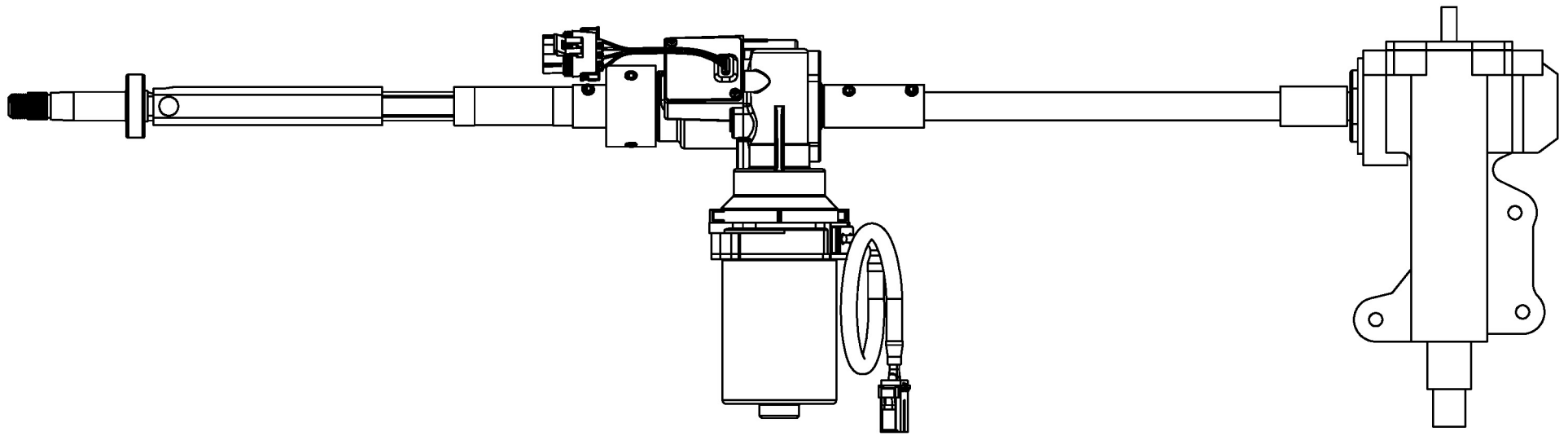



Remove clamp on steering box, dash trim piece, column clamp and horn assembly. Remove column to bench.

Cut the column on the steering wheel side, measuring at 10 $\frac{3}{4}$ ".

*55- 56 T-bird: Overall column length will be 2" shorter but the steering wheel will still be placed in the stock position.
(Image A)

Cut the column on the steering box side, measuring at 22 $\frac{5}{8}$ ". (Image B)

Cut the shaft on the slip joint side, measuring at 18". (Image C)

The center piece of tubing left over from the cuts, center wire tray (inner tube) from the upper column, and the splined shaft will not be used in this build.



The wire exit will need to be cut out as you see in the photo.

3 3/8" holes will need to be drilled, on the cut end, at 2:00, 6:00, and 10:00. These holes will be used to stake the column to the motor.

A 3/8" hole drilled, for the horn button, at 3" from the cut end. At 3 1/2", a 1/2" hole will need to be drilled. Removing the material in the middle making a 3/8" slot. (Image D)

On the lower shaft, the steel coupler, will need to be welded on.

Assemble to electric motor, install the splined end of the coupler to the splined end of the motor, tightening the set screws. Install the outer coupler with the 3 bolts, tightening down.



Install the lower portion of the column into the vehicle. Install the motor, clock and mark for staking. Return to the bench.

Remove to outer coupler, mark where the 3 holes that are on the outer edge of the coupler for further marking. Insert the coupler into the tubing, continue markings. Using these 3 marks, 3 3/8" holes will need to be drilled at 1 7/8" in on the cut end. Assemble to coupler back on the motor, as well as the tubing, leaving the 3 bolts loose. (Image A)

Reinstall the lower portion with motor back into the vehicle.

Install the upper portion, make timing marks and remove for staking.

Slide the upper portion over the coupler on the motor marking note of the 3 holes with set screws. Drill out 8mm 1/25. (Image B)

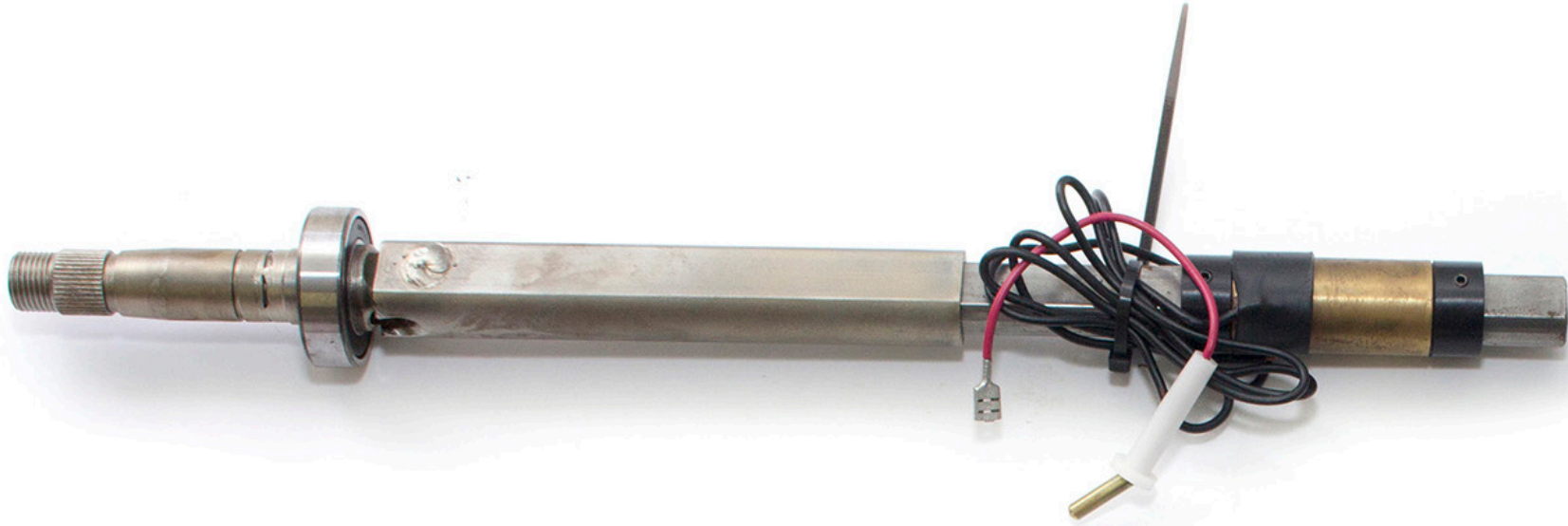

Assembly of the upper column will be a very detailed task, if you need assistance, please contact us at our information provided on the back page. Or visit our “How to” video on our webpage

Remove the horn button wire from the stock column and install into the shaft provided. Pull the through the hole on the side. Pull till button is “seated” in the top. Cut the wire 3” from the hole once “seated”

Wrap the wire attached at the bottom end of the shaft, 3 times. Cut. Splice, crimp and heat sink together.

Starting with the upper column tube, place the steering column clamp, dashboard bracket, locking retainer nut. Insert the wires from the column topper through the tube, retaining with locking nut. Tighten down the adjustment screw. Insert the shaft with horn button assembly into the column. Seal with retainer clip.

Install the upper portion into the vehicle, keep in mind the DD shaft will need to be completely seated in the DD on the motor. Tighten all the allens, align the tubing and install bolts.

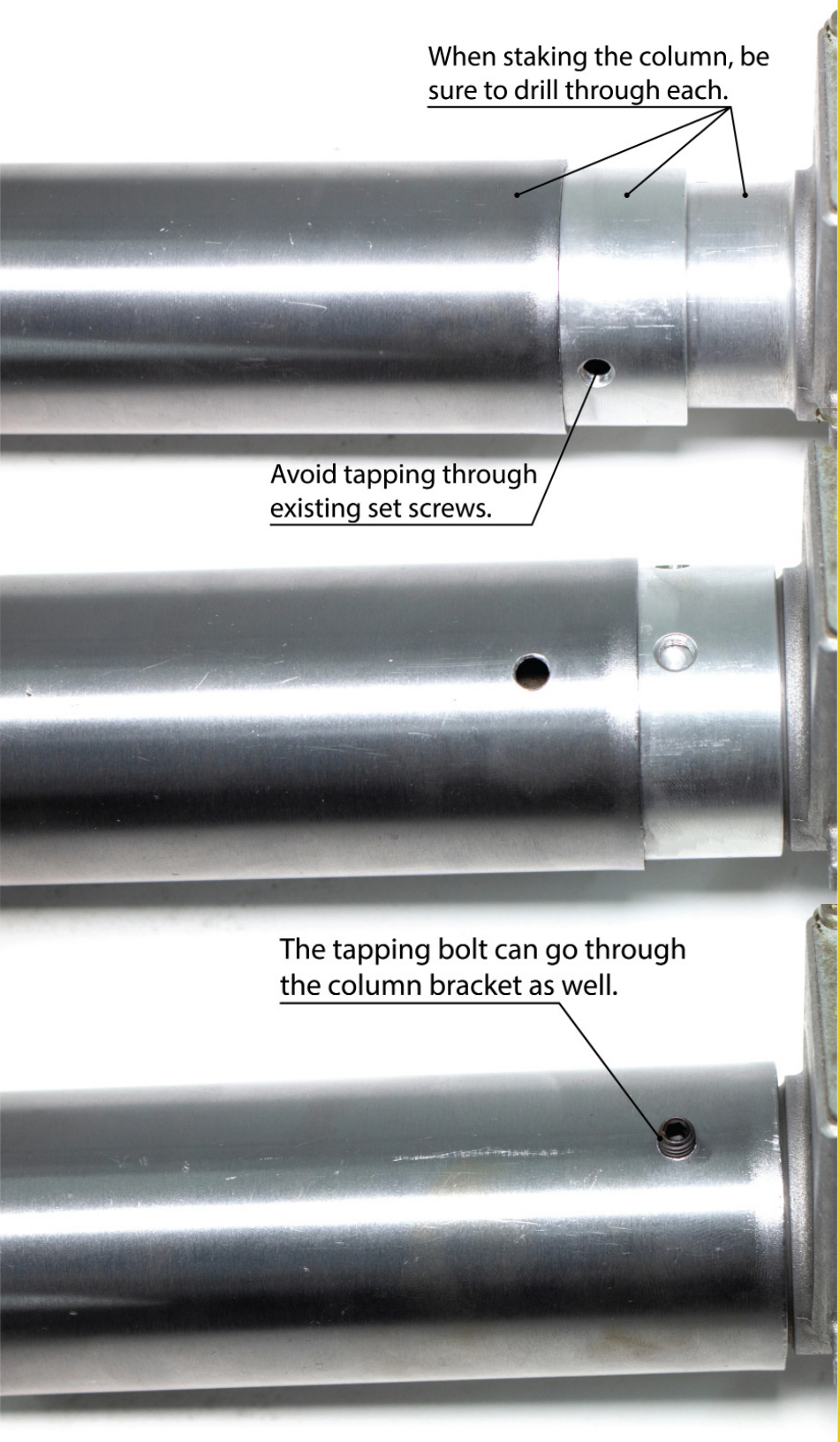

When staking the column, be sure to drill through each.

Avoid tapping through existing set screws.

The tapping bolt can go through the column bracket as well.

STAKING COLUMN:

For added stability, the column tube and motor housing can be “staked” in place to reduce the possibility of the system spinning in the vehicle. This process is suggested but not required.

To begin the staking process you will first need to clock the motor to the correct position and mark the column. Once the steering column is in place, the motor should sit between 9 and 11 O’clock position. The motor has 360° clockability to allow for an adjustable fit if the suggested position does not work.

Drill a hole through the column tube and the aluminum collar (attached to the motor) tapping the motor housing. (“Tapping” the motor housing is making a dent in the housing to ensure the bolt being used will rest in the dent) Stake the column in place using ¼-20 bolt to “sandwich” all three together.

Ensure the screw length is no more than 10mm, if it is too long it can bind the shaft. You can drill through the motor housing for additional security **(BE SURE NOT TO DRILL OR TAP INTO THE MOTOR SHAFT)**.

Loosen the columns locking nut, pull the column all the way towards you. Tighten the dash bracket. Install the module on the support bracket located under the dash. There are 2 body grounds located on either side of the plate the module rests on. Use these holes to mark location on the support bracket. Drill out with 1/4" 20. Use the 2 screws and nuts provided to mount and use for body ground.

The horn button wire provided by will need to be spliced into the OE horn button wire the runs down the column. Then inserted into the 3/4" slot that was created on the column. -We did use a zip tie to hold the wire into place to ensure it would never slip out.

****STOCK STEERING WHEELS ONLY**** Stock steering wheels will have a "dead" spline that will need to be machined out to place on the new shaft.

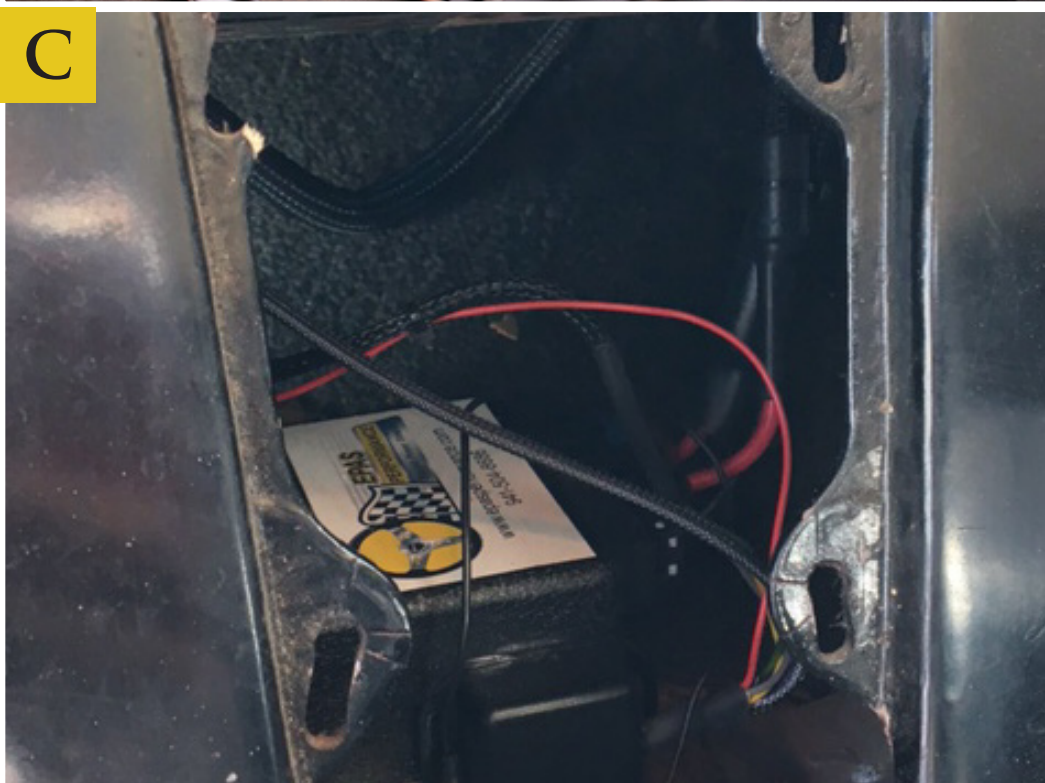
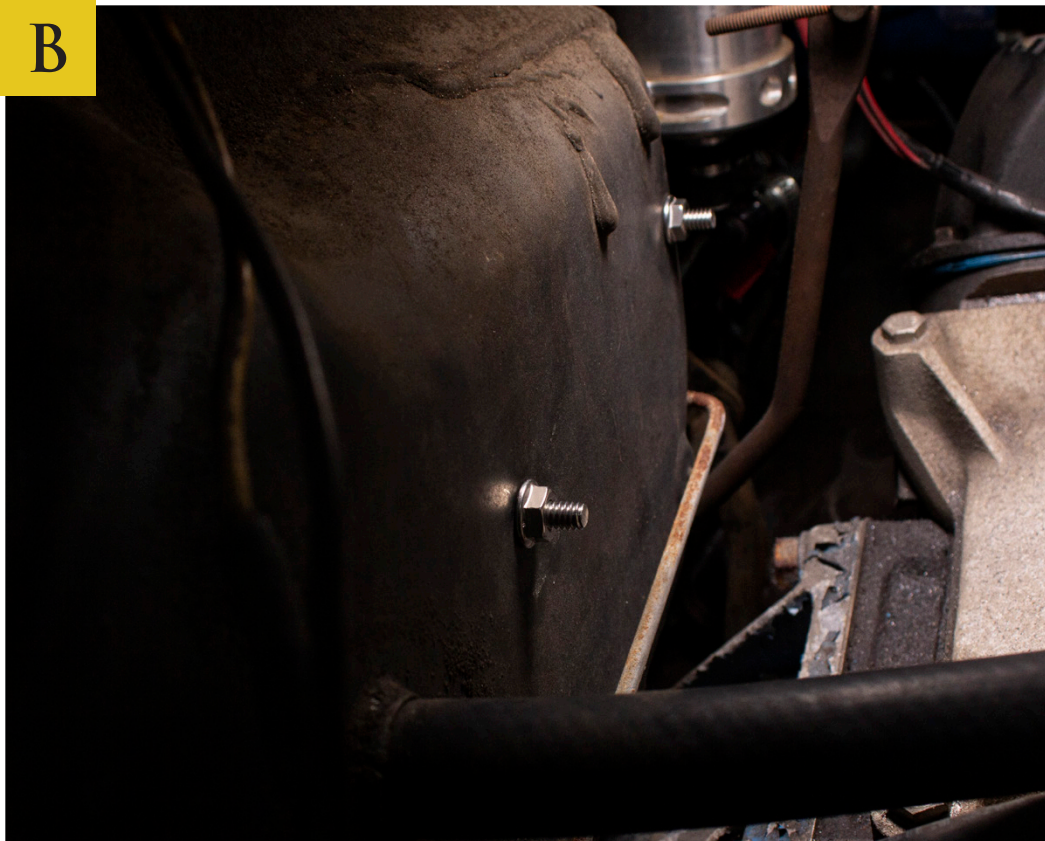

Control Module Installation:

Install the pre-wired control module and its wiring. Location inside the vehicle is at builders discretion. The recommended install location is behind the center console. A hole will need to be drilled in the firewall of the vehicle. This hole will need to be $\frac{3}{4}$ " (19mm) in diameter. The position of this hole should be next to the existing hole for the vehicles main wiring harness. This hole will be used to run the red and black battery wires. Install the provided rubber grommet.

Ensure both ground wires are properly connected to the module plate before mounting.

Connect the plug from the motor (**Blue Connector**) to the module. Connect the plug for the torque sensor (**4way**) to the module.

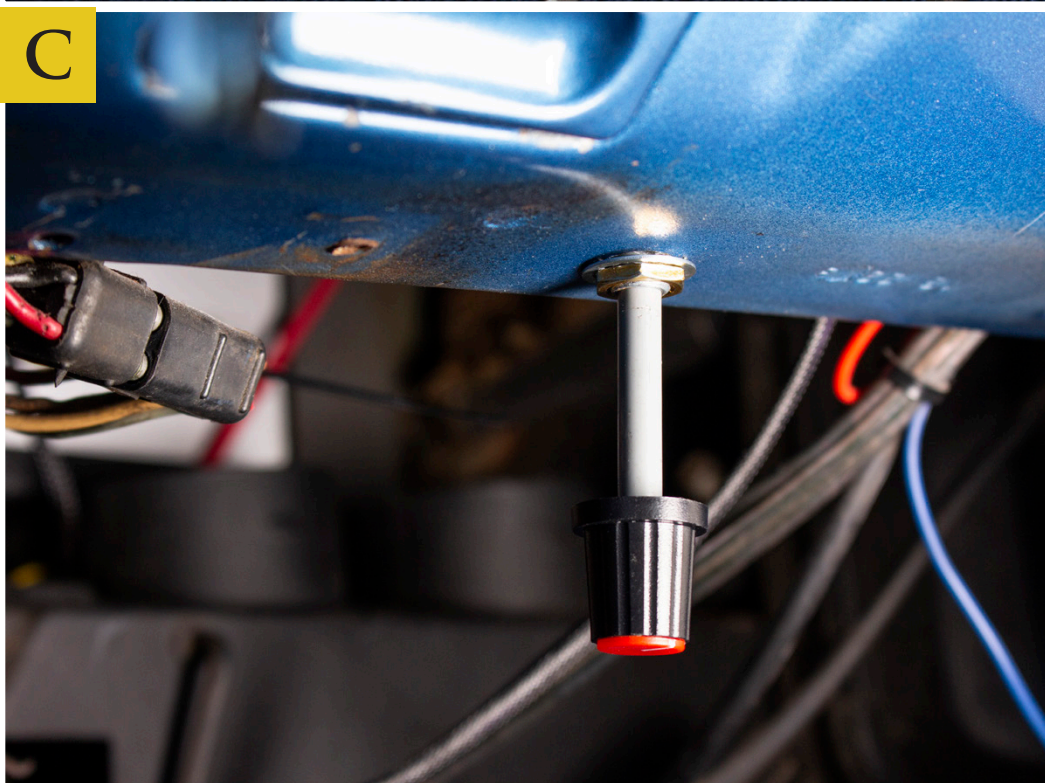
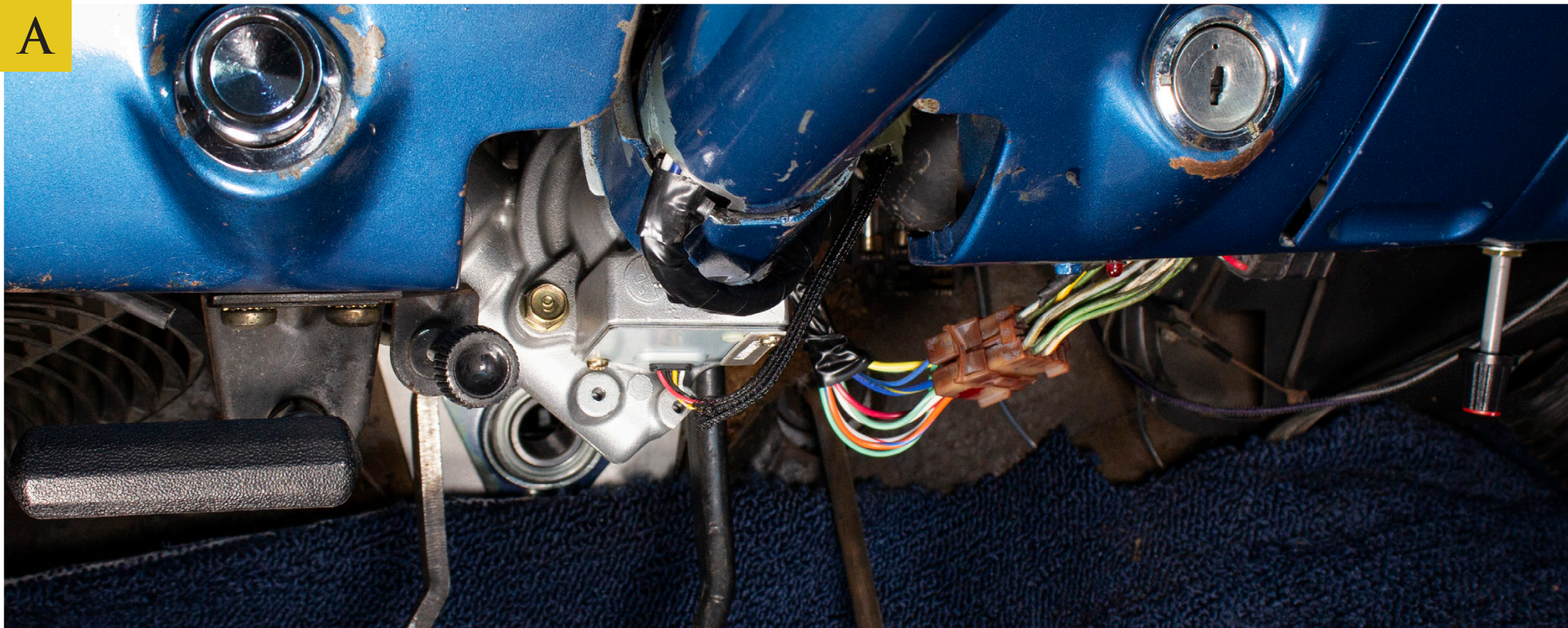

Power Wires & Potentiometer Installation:

Hook up the small red wire to a hot in run and the #10 red and black wire directly to your battery or a direct power and ground source.

Install potentiometer in an accessible location. This potentiometer allows you to adjust the strength of the assistance provided by the system. When turned fully clockwise the system will be set to maximum. Turning the dial counter clockwise will reduce the amount of assistance until none is being provided. Your steering will have returned to its original resistance; however, the system will not be completely powered down until the vehicle itself is turned off.

Wiring Diagram

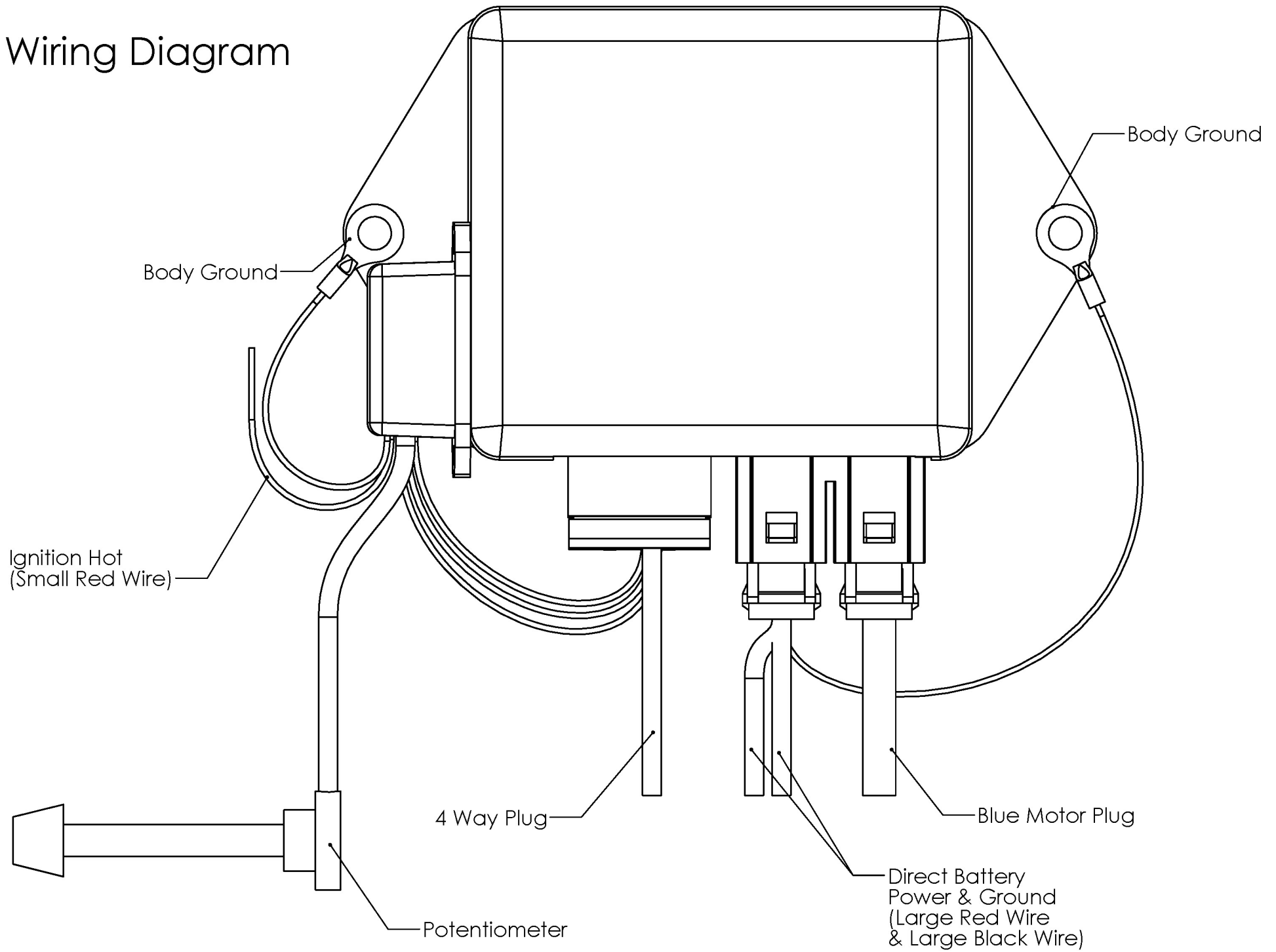

TERMS AND CONDITIONS

LIABILITY LIMITATION AND RELEASE

We are pleased you have chosen to purchase one of our automotive specialty equipment items. Our products are carefully designed to combine performance, durability and safety, and to work in concert with the vehicle's original equipment. As they are specialty products, however, and as both performance and safety are paramount concerns, we urge our customers to consider having the products professionally installed.

We caution the purchaser that the enhancement provided by the specialty equipment item may change the handling characteristics of the vehicle. We urge the purchaser to carefully familiarize him/herself with the vehicle's performance characteristics with the new equipment. This should be done in a safe environment and in a safe manner.

We have no control over the quality or correctness of equipment installations performed by others, nor can we control the uses (in manner or environment) products are subjected to. Accordingly, liability on the part of EPAS Performance LLC is limited to the terms of its Express Limited Warranty.

A decision by the purchaser to retain and install the item purchased will be deemed acceptance of the specific terms of this Liability Limitation and Release.

The purchaser expressly releases and waives any claim against us for any consequential damages or injury that may arise from the use, or any malfunction, of its product. This Liability Limitation and Release binds the original purchaser, all successors in interest, and all persons to whom the product may subsequently be transferred; and the purchaser agrees to make this limitation known to all such persons. This Liability Limitation and Release is part of the consideration for the sale of the product.

This Liability Limitation and Release is governed by the laws of the State of Florida, United States of America. Any dispute regarding its terms or application is subject to arbitration in the State of Florida at the request of either party to the sale.

WARRANTY

This warranty is limited to the repair or replacement of the defective part only; the warranty specifically excludes labor or consequential damages or injury. The decision as to whether the defective part will be repaired or replaced will rest solely with the manufacturer. The warranty period begins on the date the product is shipped to you.

Full 5-year warranty nontransferable.

This warranty is void if the product is or was improperly installed, abused in any manner. Road or accident damage is not covered.

To make a claim under this warranty, call EPAS Performance to return the defective product, shipping or postage prepaid. Please include a copy of the original purchase invoice and a note describing the circumstances of the failure or malfunction.

This warranty is governed by the laws of the State of Florida, United States of America. Any dispute regarding the coverage of this warranty, its application or terms is subject to arbitration in the State of Florida.

If the purchaser disagrees with any of the terms of this warranty, please return the purchased item within three (3) business days of receipt. A decision by the purchaser to retain and install the item purchased will be deemed acceptance of the specific terms of this warranty.

**Thank you for purchasing the EPAS Performance electric power system.
We do hope you enjoy your vehicle for many miles to come.**

