



1954-'83 Jeep CJ 5 | Willies

Installation Guide

Table of Contents

- Required tools
- Kit contents
- Motor Orientation Diagram
- Steering column and wheel removal
- Steering column modifications
 - disassembly
 - cut lengths
- Column and motor reassembly
- Steering box reinstallation
- Steering wheel and column installation
- Column staking guide
- Module and potentiometer installation
- Wiring diagram
- Warranty and product disclaimer

WARNING



Please read and understand this manual before installing your EPAS kit.

The installation of this system should be done by a professional mechanic or a very knowledgeable amateur. You will be cutting and splicing your steering column, therefore EPAS Performance will not be held responsible for any malpractice. Caution should be taken when installing the electric motor: no impacts, shocks or hammering should be done to the unit. For aesthetic reason, you may choose to paint the assembly either in black or the color of your steering column to conserve the original look.

For a complete understanding, we strongly suggest to read this owner's manual prior to any installation.

Should you have any questions or concerns feel free to contact us at (941) 893-5427 or visit our website for installation videos.

EPAS Performance wishes you thousands of enjoyable miles with your new Electric Power Steering!



Required tools:

- Drill
- Right angle grinder, with cutting disc
- Eye protection
- Measuring tape
- Steering wheel removal tool
- You will also need hand tools to remove the steering column

1954-'64 Jeep CJ 5 | Willies

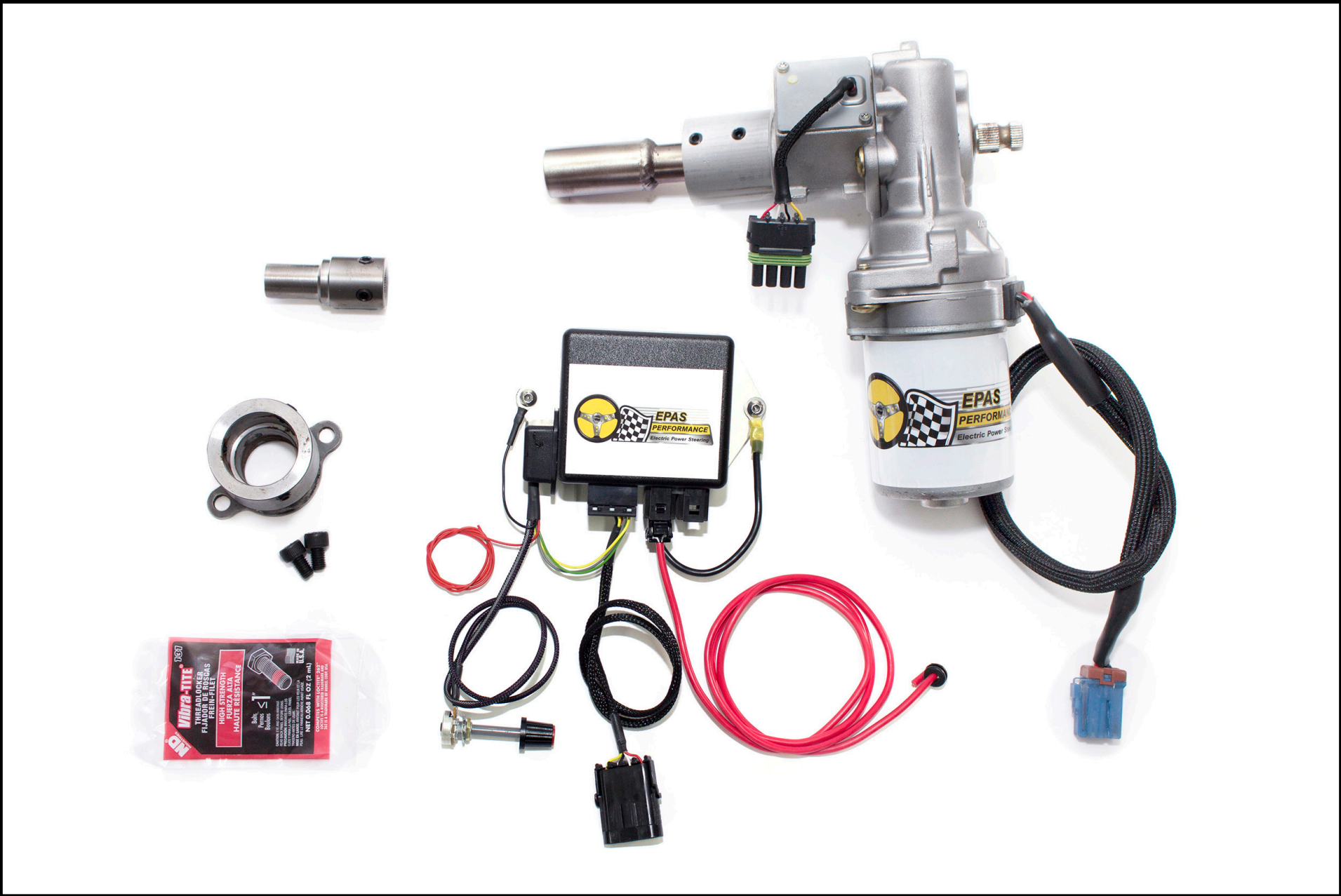

Motor Orientation Diagram

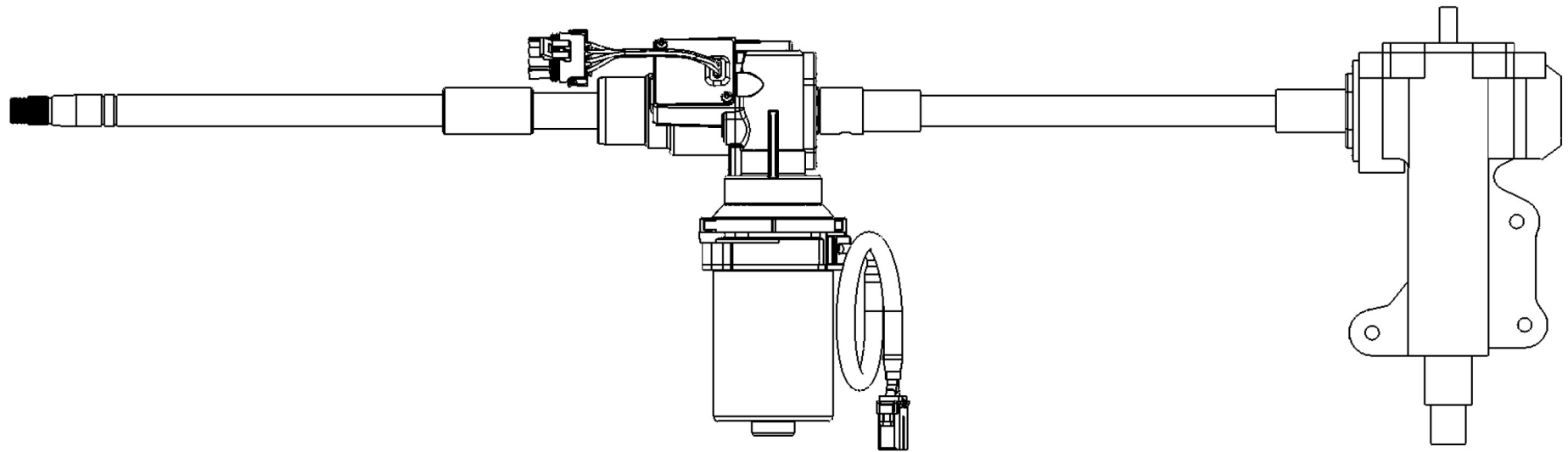

Remove Column Assembly:

To begin the install you will need to remove and disassemble the OEM steering column. Remove the hood of the vehicle as additional clearance will be required in order for the steering column to be removed. We also recommend that the drivers seat be removed.

Remove steering wheel and disconnect the turn signal wire assembly. Remove the wire assembly from the steering column.

Remove the steering column bracket holding the column to the dash.

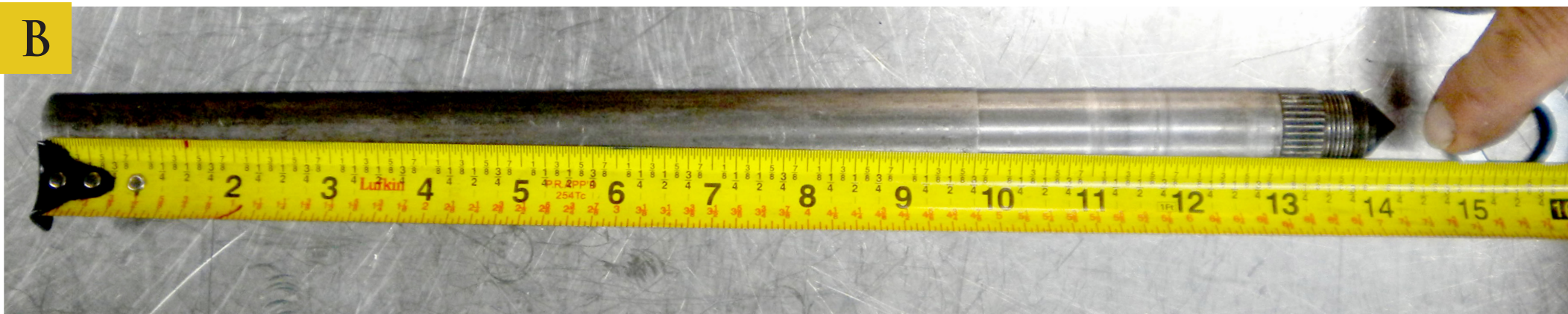
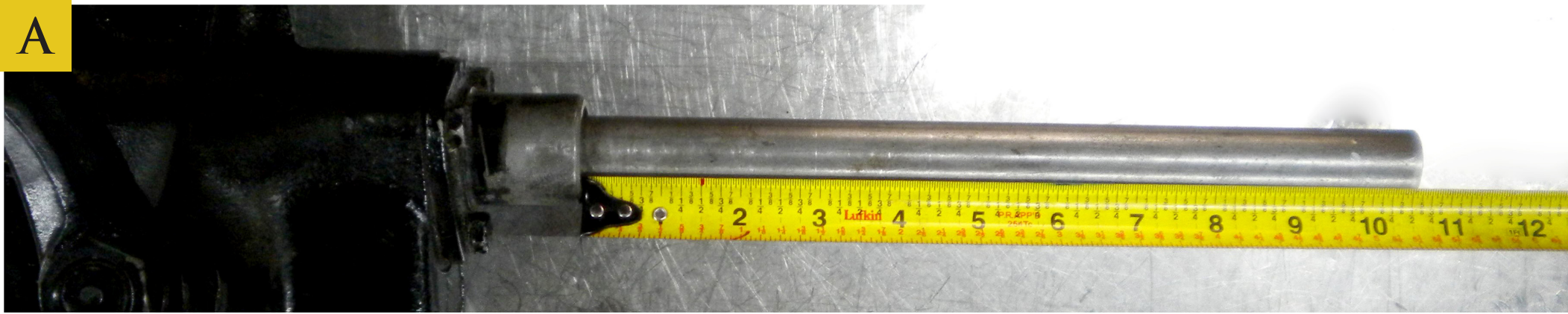

Shaft Modifications:

Remove the column tube from the shaft.

Measuring 10 ½” from the steering box outer flange (shown in photo above) and cut through the steering shaft.

On the splined shaft length, from the splined side, Measure out 14 ¼” – Cut off this portion. The remaining shaft will not be used.

For convenience, the steering wheel column tube and steering shaft will be referred to as the upper section. The steering box column tube and steering shaft will be referred to as the lower section.

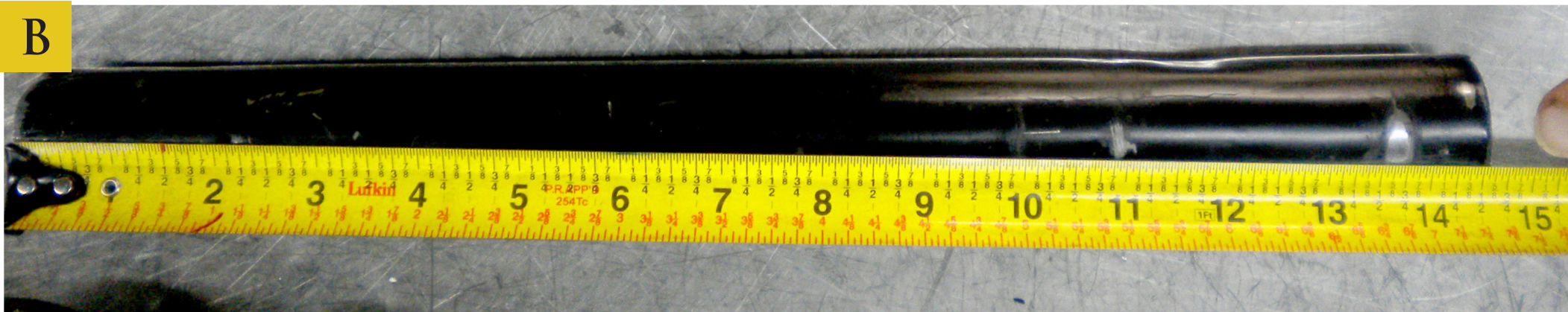
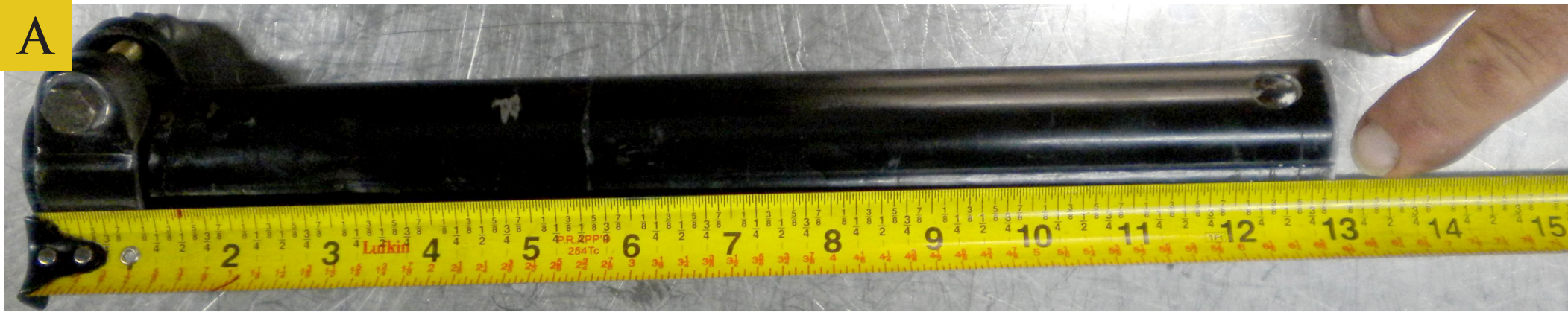

Column Modifications:

The column tube will be cut measuring at 13" from steering box side.

Measuring from the steering wheel side, cut the column tube at 14 ½". The remaining tube will not be used.



Lower Section Modifications:

On the newly cut lower shaft, a $\frac{3}{4}$ " DD will need to be made measuring $1 \frac{1}{2}$ " from the cut end. You will need to mill 0.105" from both sides of the shaft to create the DD section.

Measuring 1" in from the cut end of the lower column tube, a $\frac{1}{2}$ " hole will need to be drilled in order to access the setscrews once fully assembled. Once this hole has been made, the column and steering box can be reassembled.

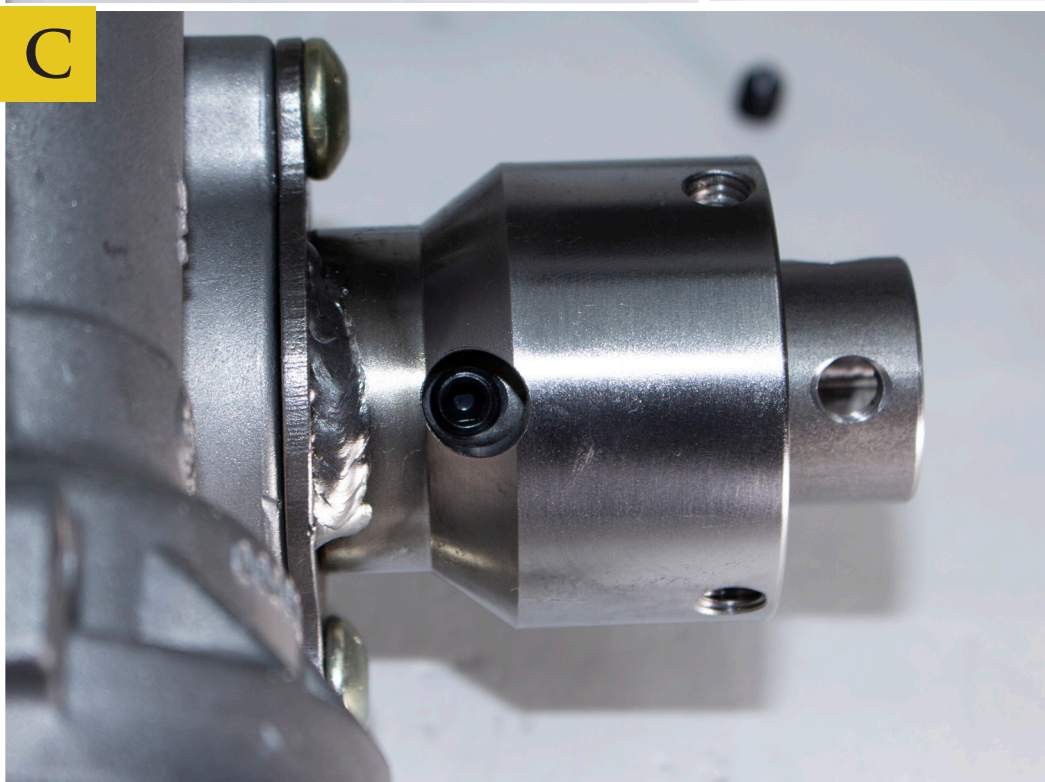
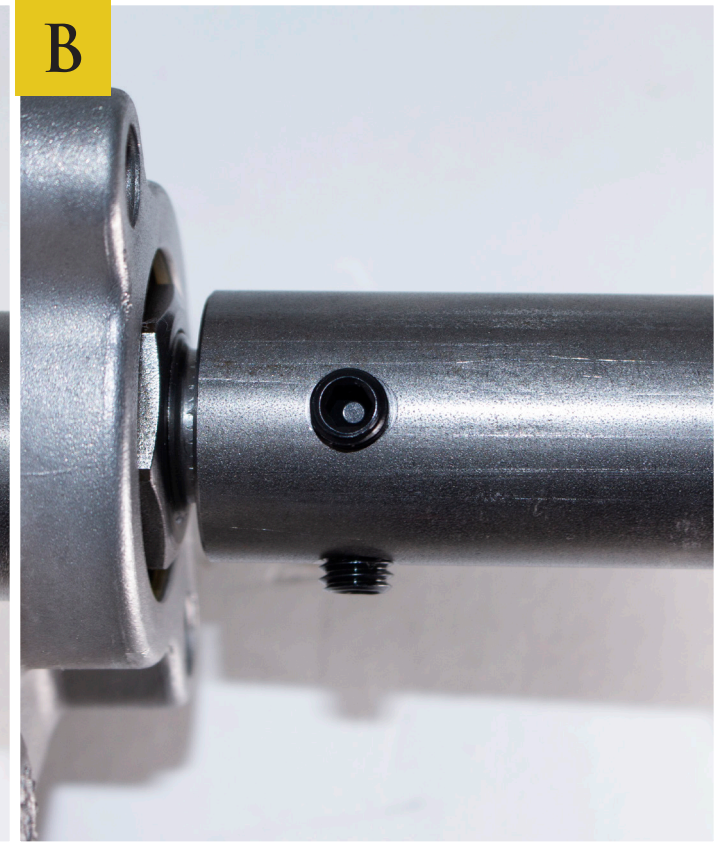
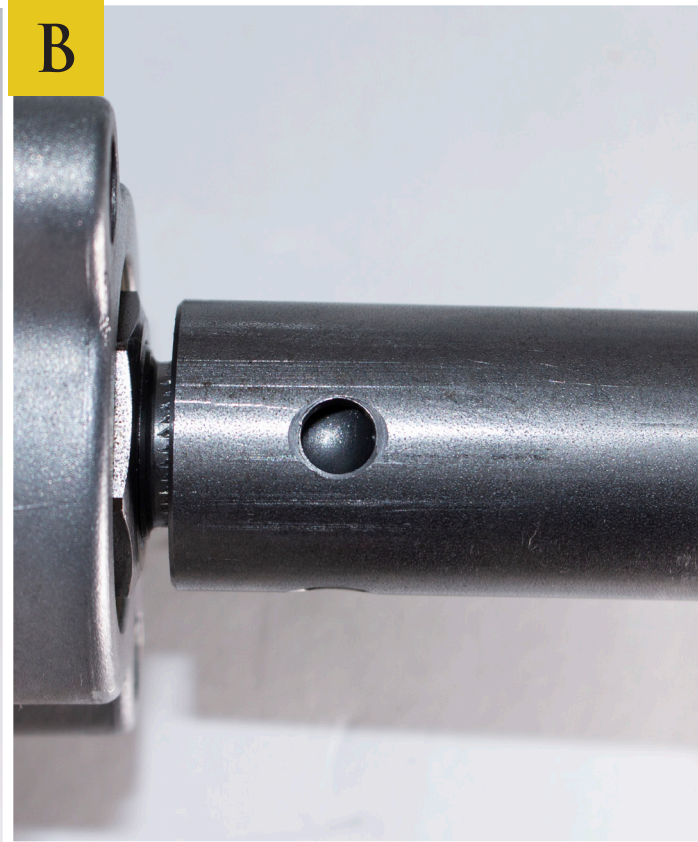

Column and Motor Assembly:

Assemble the spline to 3/4" DD adapter to the back of the motor. Insure it is fully seated and tighten the spline setscrews. (Setscrews should be seated in the section between the two sets of splines.)

Attach the steering column adapter to the back of the motor using the two provided bolts.

Reassemble the lower steering box and shaft. Be sure to return the bearings to their original placement.

Steering Box and Lower Column Installation:

Reinstall the steering box into the vehicle, replacing the pitman arm and tightening all bolts to final tightness.

Install the EPAS Performance motor assembly onto the lower column tube and steering shaft. Ensure the steering shaft is fully seated in the DD coupler.

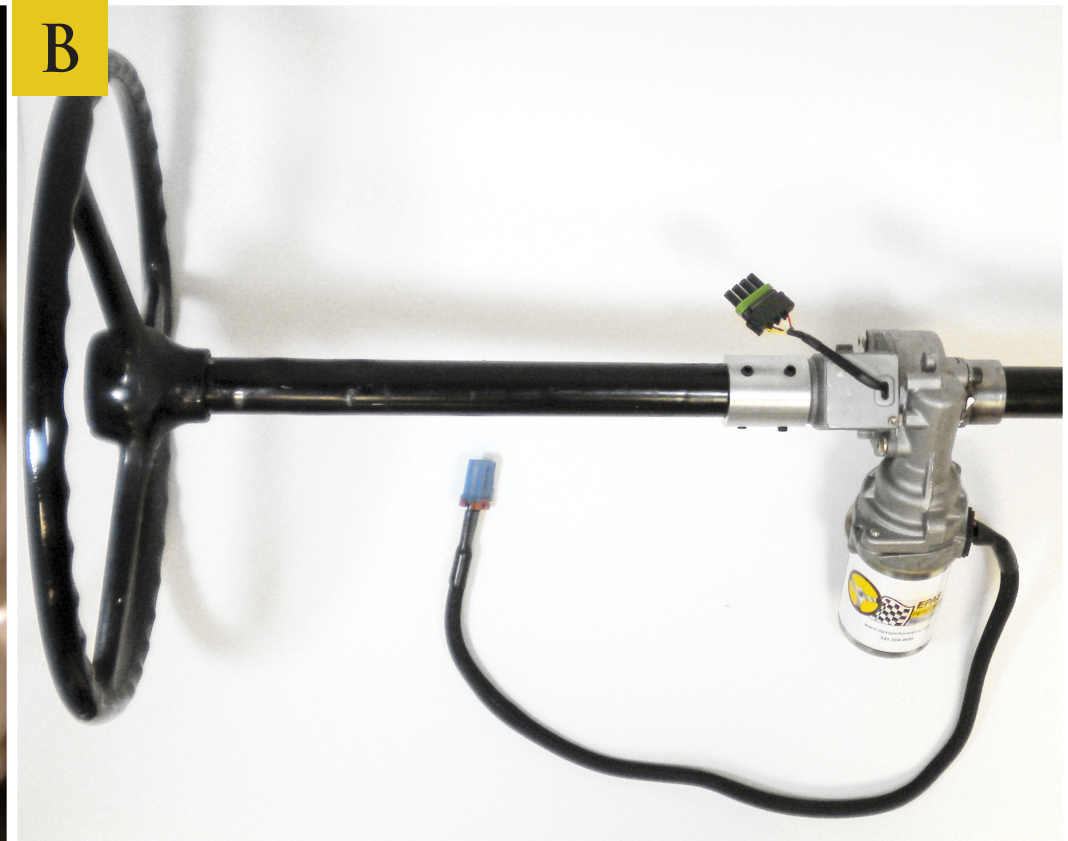

Steering Wheel and Upper Column Installation:

Weld the upper steering shaft to the EPAS motor ensuring the shaft is fully seated into the motor.

Install column tube fully into the aluminum collar on the motor. Do not fully tighten set screws until motor is clocked to its final position.

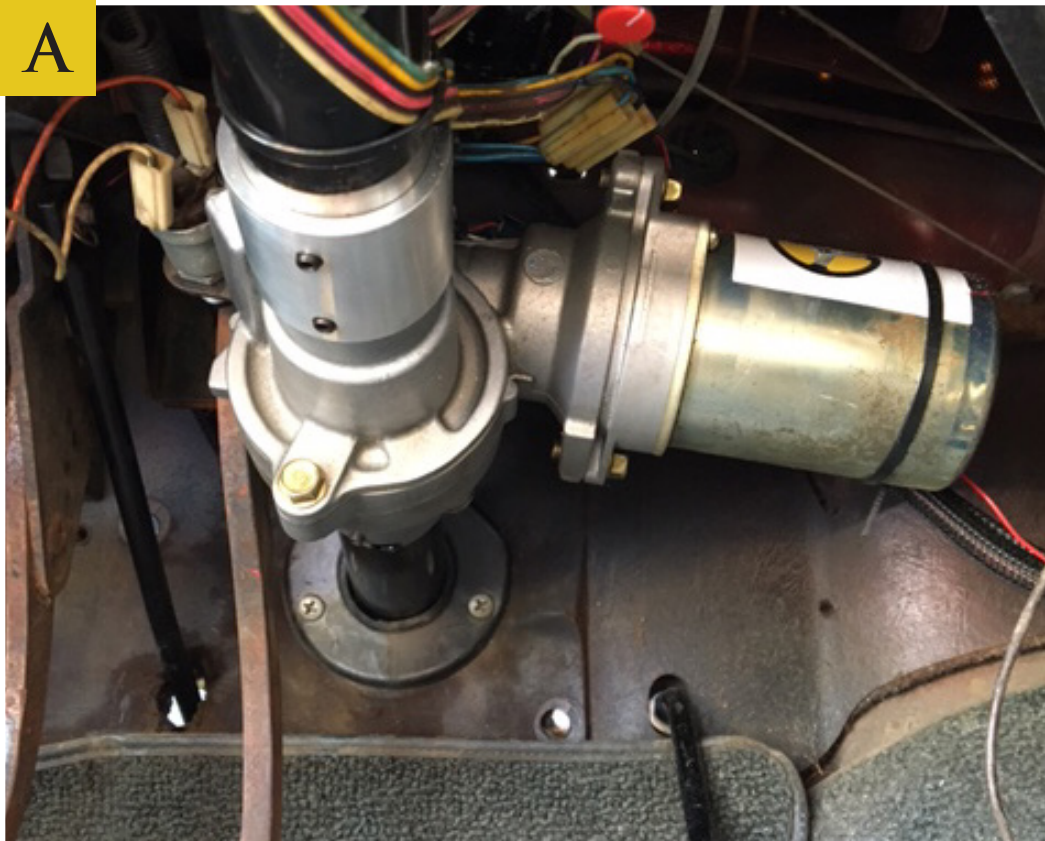

System Clocking:

Clock the EPAS motor to the position that best fits your vehicle and tighten all the set screws. The motor is 360° clockable; it can be safely adjusted to any position.

Use the 1/2" hole to install the knurled setscrews that holds the steering shaft into the adapter on the EPAS motor. Both setscrews can be accessed through this hole by simply turning the steering shaft where the steering wheel mounts.

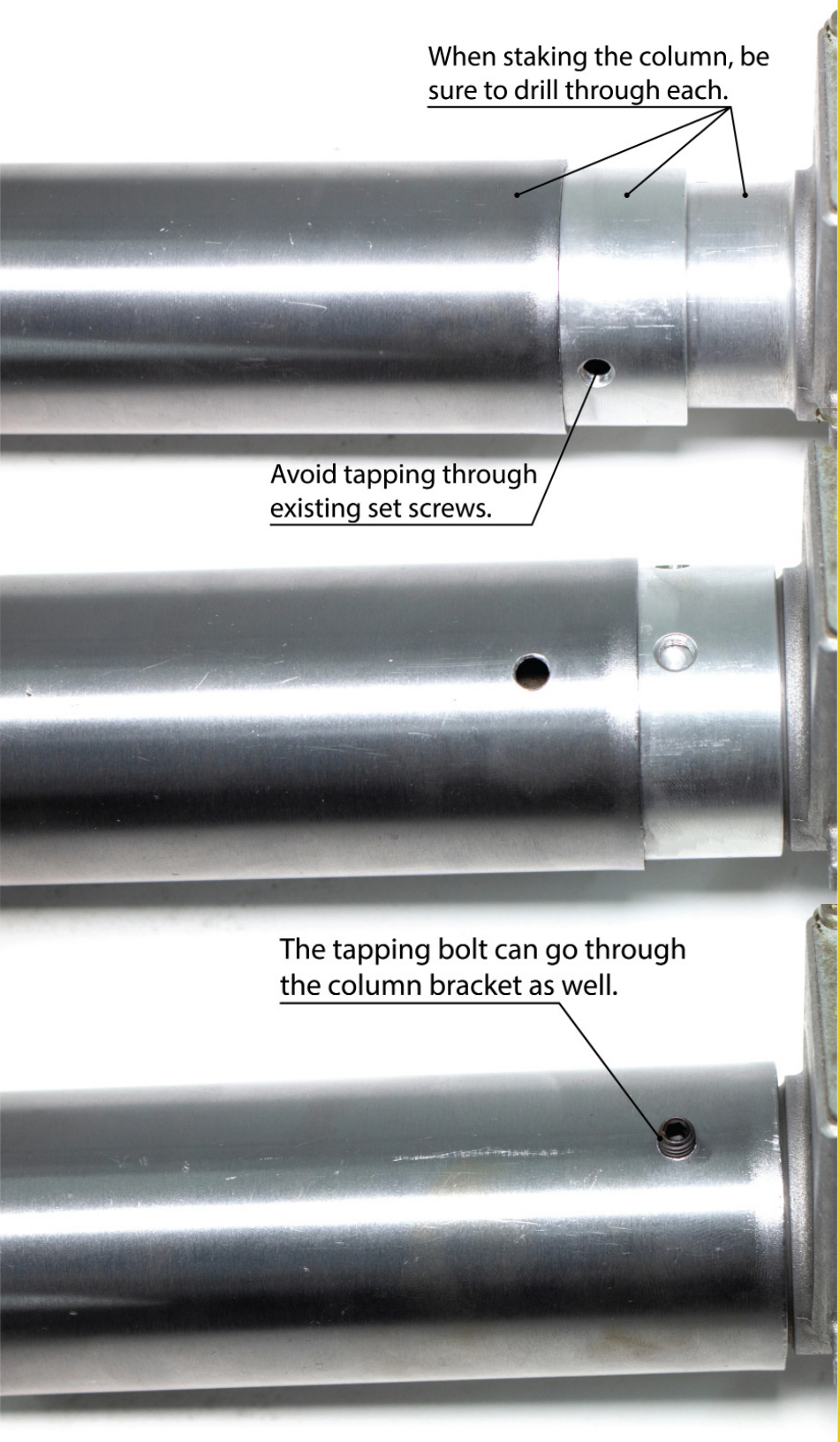

When staking the column, be sure to drill through each.

Avoid tapping through existing set screws.

The tapping bolt can go through the column bracket as well.

STAKING COLUMN:

For added stability, the column tube and motor housing can be “staked” in place to reduce the possibility of the system spinning in the vehicle. This process is suggested but not required.

To begin the staking process you will first need to clock the motor to the correct position and mark the column. Once the steering column is in place, the motor should sit between 9 and 11 O’clock position. The motor has 360° clockability to allow for an adjustable fit if the suggested position does not work.

Drill a hole through the column tube and the aluminum collar (attached to the motor) tapping the motor housing. (“Tapping” the motor housing is making a dent in the housing to ensure the bolt being used will rest in the dent) Stake the column in place using ¼-20 bolt to “sandwich” all three together.

Ensure the screw length is no more than 10mm, if it is too long it can bind the shaft. You can drill through the motor housing for additional security (**BE SURE NOT TO DRILL OR TAP INTO THE MOTOR SHAFT**).

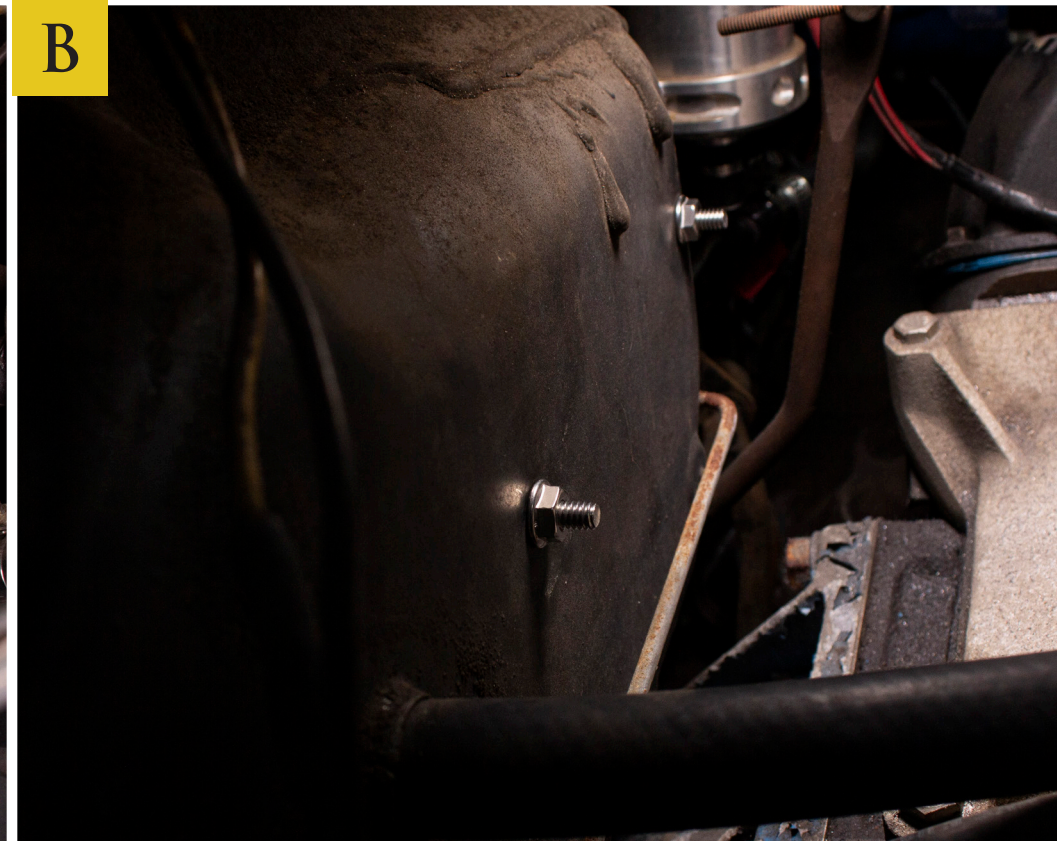

Control Module Installation:

Install the pre-wired control module and its wiring. Location inside the vehicle is at builders discretion.

Ensure both ground wires are properly connected to the module plate before mounting.

Connect the plug from the motor (**Blue Connector**) to the module. Connect the plug for the torque sensor (**4way**) to the module.

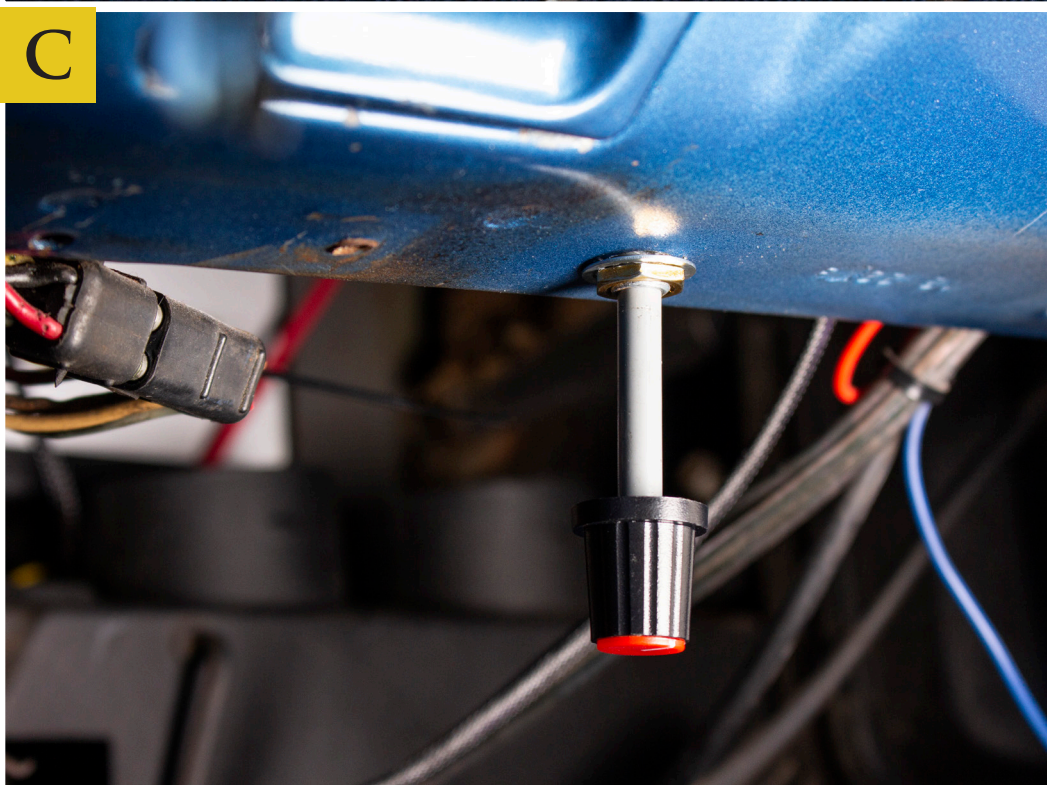
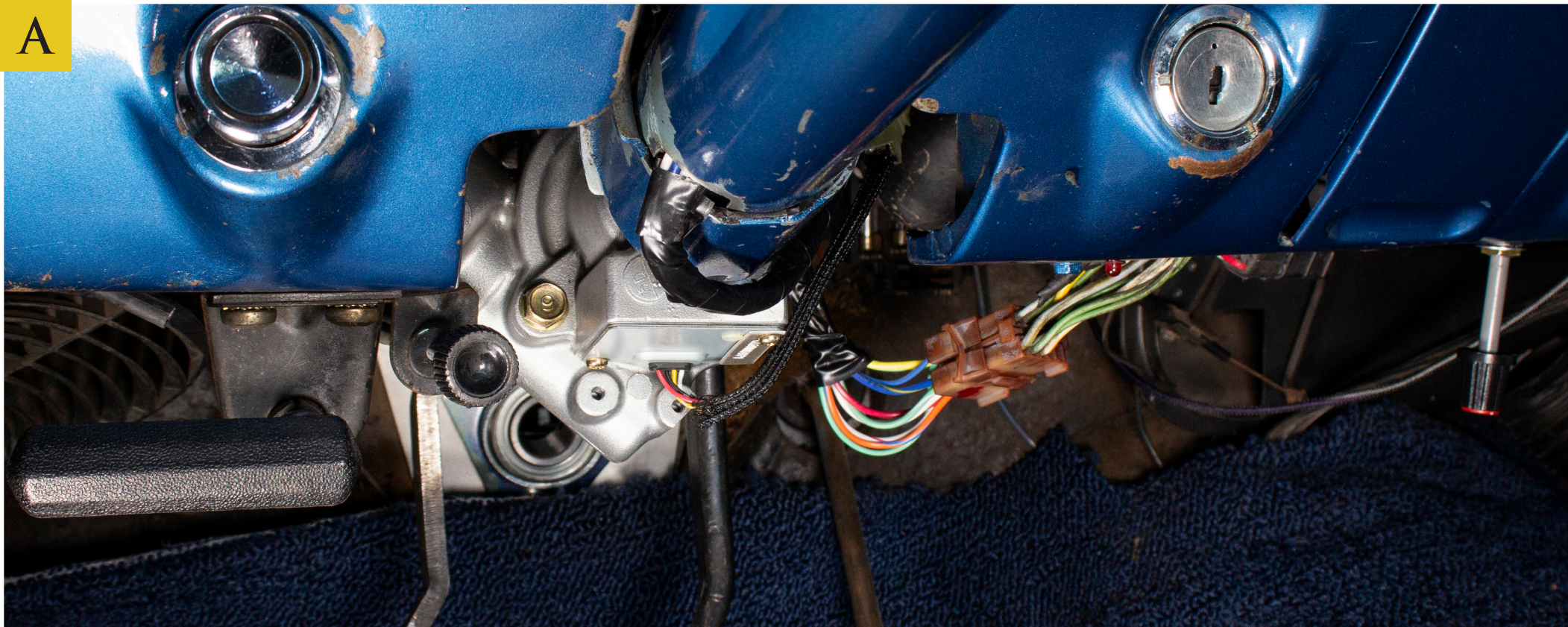

Power Wires & Potentiometer Installation:

Reconnect the column wiring harness to the vehicle.

Hook up the small red wire to a hot in run and the #10 red and black wire directly to your battery or a direct power and ground source.

Install potentiometer in an accessible location. This potentiometer allows you to adjust the strength of the assistance provided by the system. When turned fully clockwise the system will be set to maximum. Turning the dial counter clockwise will reduce the amount of assistance until none is being provided. Your steering will have returned to its original resistance; however, the system will not be completely powered down until the vehicle itself is turned off.

Module Wiring Diagram

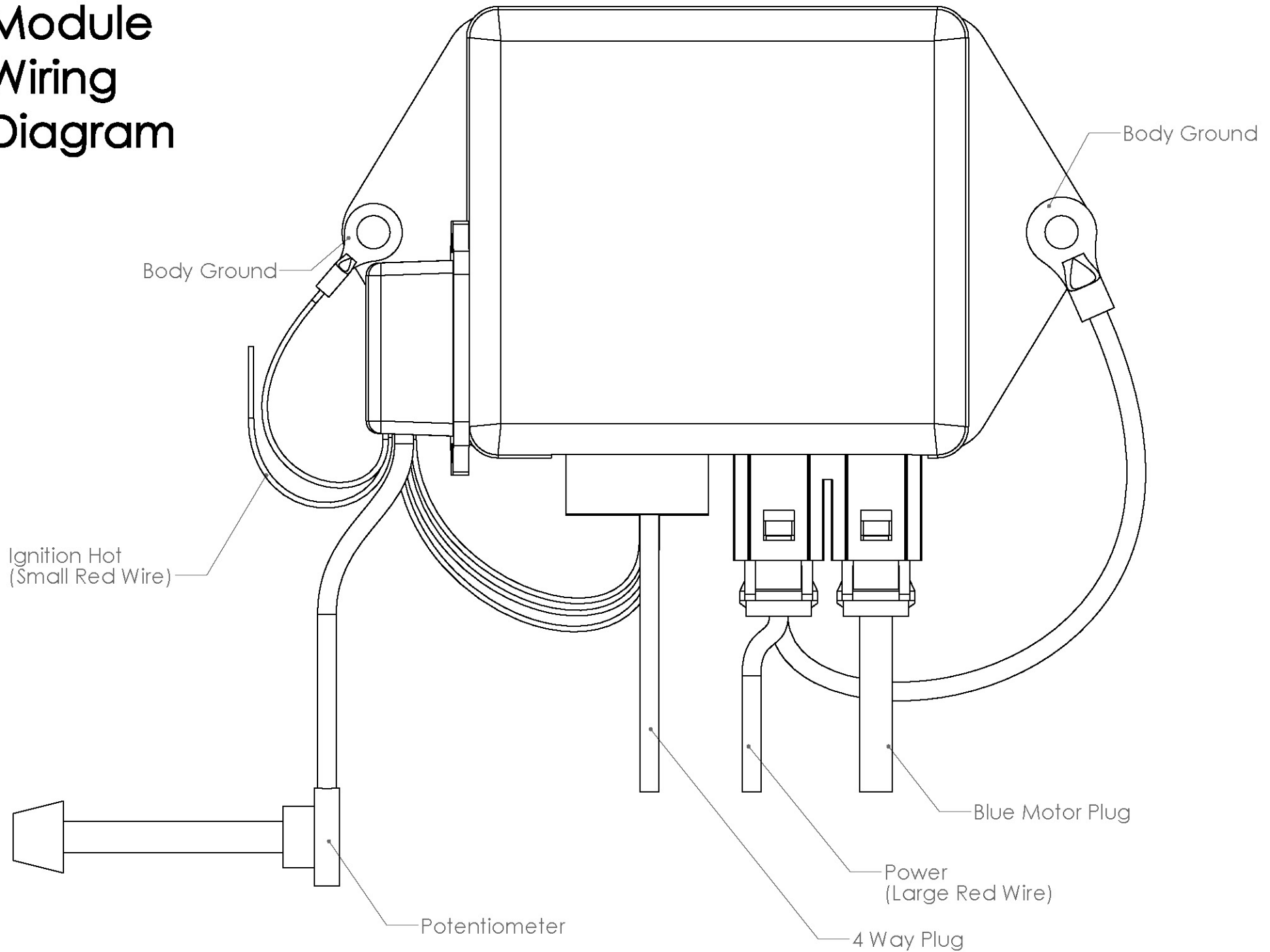

TERMS AND CONDITIONS

LIABILITY LIMITATION AND RELEASE

We are pleased you have chosen to purchase one of our automotive specialty equipment items. Our products are carefully designed to combine performance, durability and safety, and to work in concert with the vehicle's original equipment. As they are specialty products, however, and as both performance and safety are paramount concerns, we urge our customers to consider having the products professionally installed.

We caution the purchaser that the enhancement provided by the specialty equipment item may change the handling characteristics of the vehicle. We urge the purchaser to carefully familiarize him/herself with the vehicle's performance characteristics with the new equipment. This should be done in a safe environment and in a safe manner.

We have no control over the quality or correctness of equipment installations performed by others, nor can we control the uses (in manner or environment) products are subjected to. Accordingly, liability on the part of EPAS Performance LLC is limited to the terms of its Express Limited Warranty.

A decision by the purchaser to retain and install the item purchased will be deemed acceptance of the specific terms of this Liability Limitation and Release.

The purchaser expressly releases and waives any claim against us for any consequential damages or injury that may arise from the use, or any malfunction, of its product. This Liability Limitation and Release binds the original purchaser, all successors in interest, and all persons to whom the product may subsequently be transferred; and the purchaser agrees to make this limitation known to all such persons. This Liability Limitation and Release is part of the consideration for the sale of the product.

This Liability Limitation and Release is governed by the laws of the State of Florida, United States of America. Any dispute regarding its terms or application is subject to arbitration in the State of Florida at the request of either party to the sale.

WARRANTY

This warranty is limited to the repair or replacement of the defective part only; the warranty specifically excludes labor or consequential damages or injury. The decision as to whether the defective part will be repaired or replaced will rest solely with the manufacturer. The warranty period begins on the date the product is shipped to you.

Full 5-year warranty nontransferable.

This warranty is void if the product is or was improperly installed, abused in any manner. Road or accident damage is not covered.

To make a claim under this warranty, call EPAS Performance to return the defective product, shipping or postage prepaid. Please include a copy of the original purchase invoice and a note describing the circumstances of the failure or malfunction.

This warranty is governed by the laws of the State of Florida, United States of America. Any dispute regarding the coverage of this warranty, its application or terms is subject to arbitration in the State of Florida.

If the purchaser disagrees with any of the terms of this warranty, please return the purchased item within three (3) business days of receipt. A decision by the purchaser to retain and install the item purchased will be deemed acceptance of the specific terms of this warranty.

**Thank you for purchasing the EPAS Performance electric power system.
We do hope you enjoy your vehicle for many miles to come.**

