



# 1948-'66 Ford F100

## Installation Guide

Pictures may vary per application

# Table of Contents

- Required tools
- Kit contents
- Motor Orientation Diagram
- Steering column and wheel removal
- Steering column modifications
  - disassembly
  - cut lengths
  - wire exit relocation
- Bearing plate installation
- Firewall plate installation
- Column and motor reassembly
- Column staking guide
- Lower portion installation
- Module and potentiometer installation
- Wiring diagram
- Warranty and product disclaimer

## WARNING



**Please read and understand this manual before installing your EPAS kit.**

The installation of this system should be done by a professional mechanic or a very knowledgeable amateur. You will be cutting and splicing your steering column, therefore EPAS Performance will not be held responsible for any malpractice. Caution should be taken when installing the electric motor: no impacts, shocks or hammering should be done to the unit. For aesthetic reason, you may choose to paint the assembly either in black or the color of your steering column to conserve the original look.

For a complete understanding, we strongly suggest to read this owner's manual prior to any installation.

**Should you have any questions or concerns feel free to contact us at (941) 893-5427 or visit our website for installation videos.**

EPAS Performance wishes you thousands of enjoyable miles with your new Electric Power Steering!



### **Required tools:**

- Drill
- Right angle grinder, with cutting disc
- Eye protection
- Measuring tape
- Steering wheel removal tool
- You will also need hand tools to remove the steering column

# 1953-'56 Ford F100



# Motor Orientation Diagram

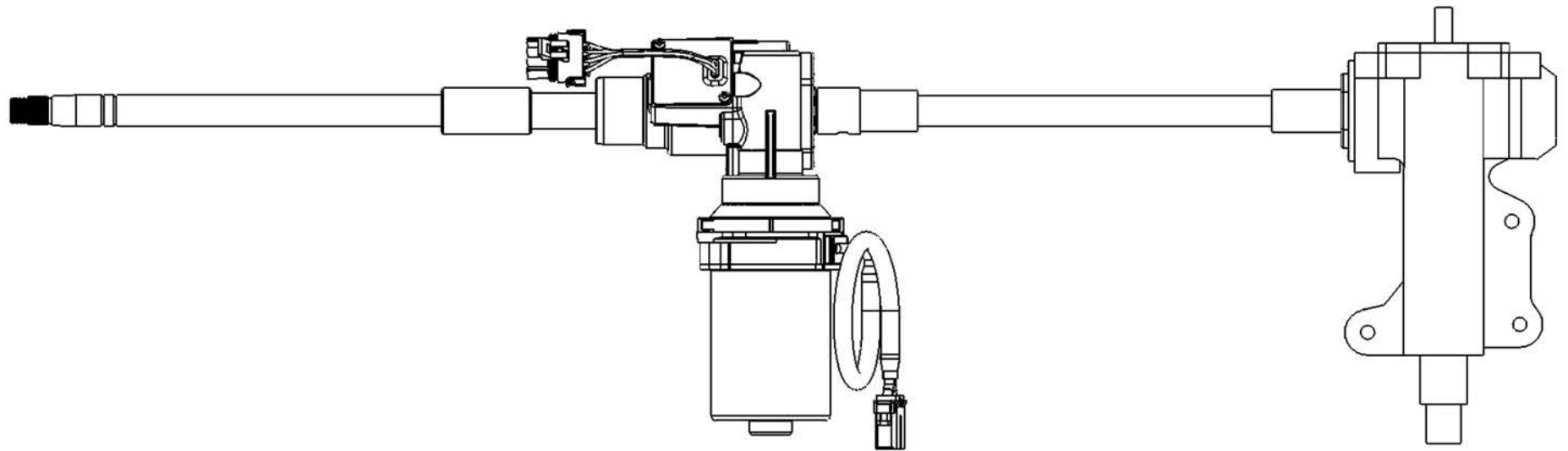





## Remove Column Assembly:

To begin the install you will need to remove and disassemble the OEM steering column. Remove the hood of the vehicle as additional clearance will be required in order for the steering column to be removed. We also recommend that the drivers seat be removed.

Remove steering wheel and disconnect the turn signal wire assembly. Remove the wire assembly from the steering column.

Remove the steering column bracket holding the column to the dash.

Detach the pitman arm from the steering box and remove the bolts holding the lower steering column/steering box in place.

Once all bolts and brackets are released the steering column can be removed from the vehicle.

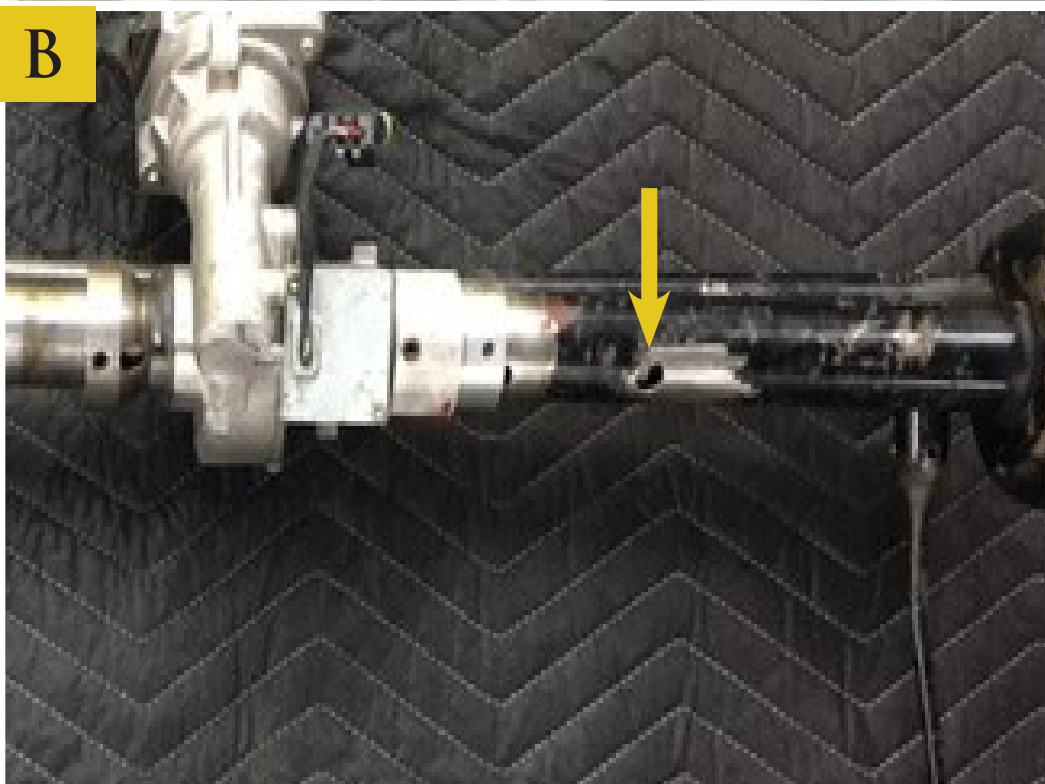

## Column Modifications:

Measuring from the steering box side, make a cut at  $16 \frac{3}{4}$ "

From that same cut line, continuing away from the steering box, measure another  $6 \frac{5}{8}$ " and cut. This middle portion can be safely discarded.

On the upper portion (steering wheel side) of the column, a  $\frac{1}{2}$ " hole will need to be drilled, measuring from the previous cut end at  $3 \frac{1}{2}$ "





## Shaft Modifications:

Measuring from the flange on the steering box, the shaft will need to be cut at 15". Once cut has been made, weld on the provided EPAS coupler to the end of the shaft. The remaining shaft can be safely discarded as it will be replaced by the provided shaft in your EPAS kit.

Reinstall the steering shaft into the column.



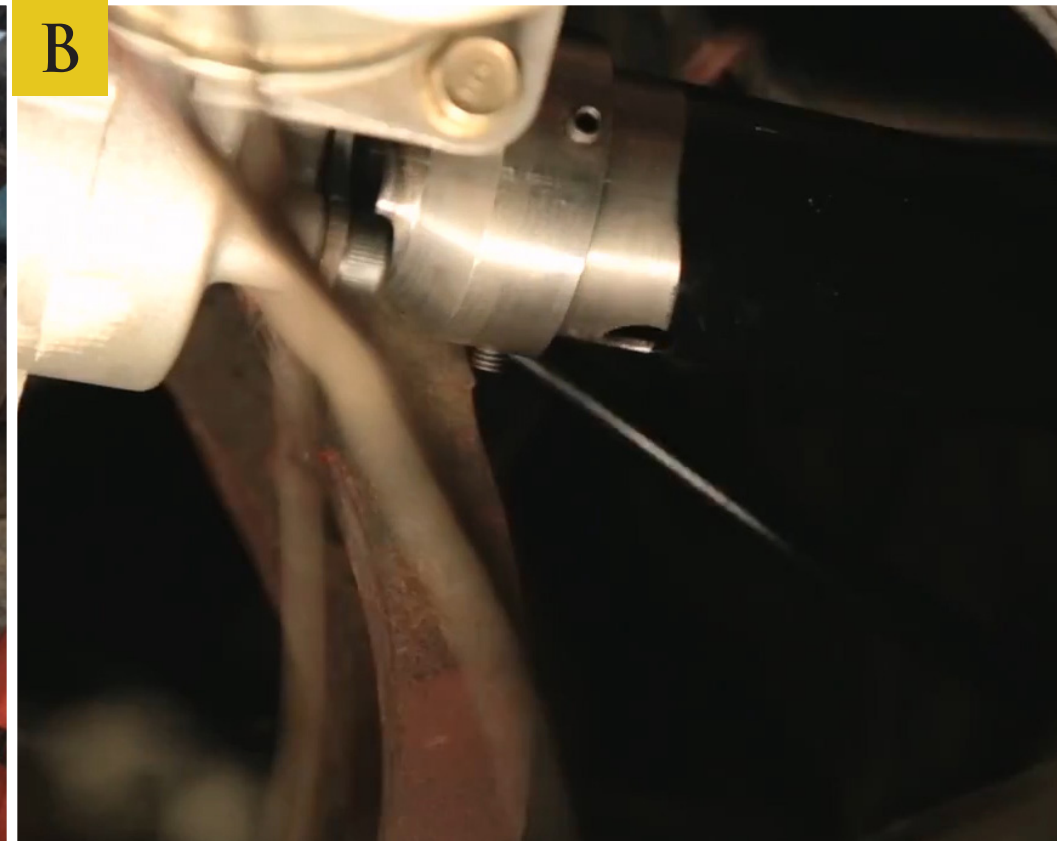

## Steering Box and Column Installation:

Reinstall the steering box into the vehicle, replacing the pitman arm and tightening all bolts to final tightness.

Attach the steering column adapter to the back of the motor using the two provided bolts.

Install the EPAS Performance motor assembly onto the lower column tube and steering shaft.

The motor is 360° clockable; it can be safely adjusted to any position.

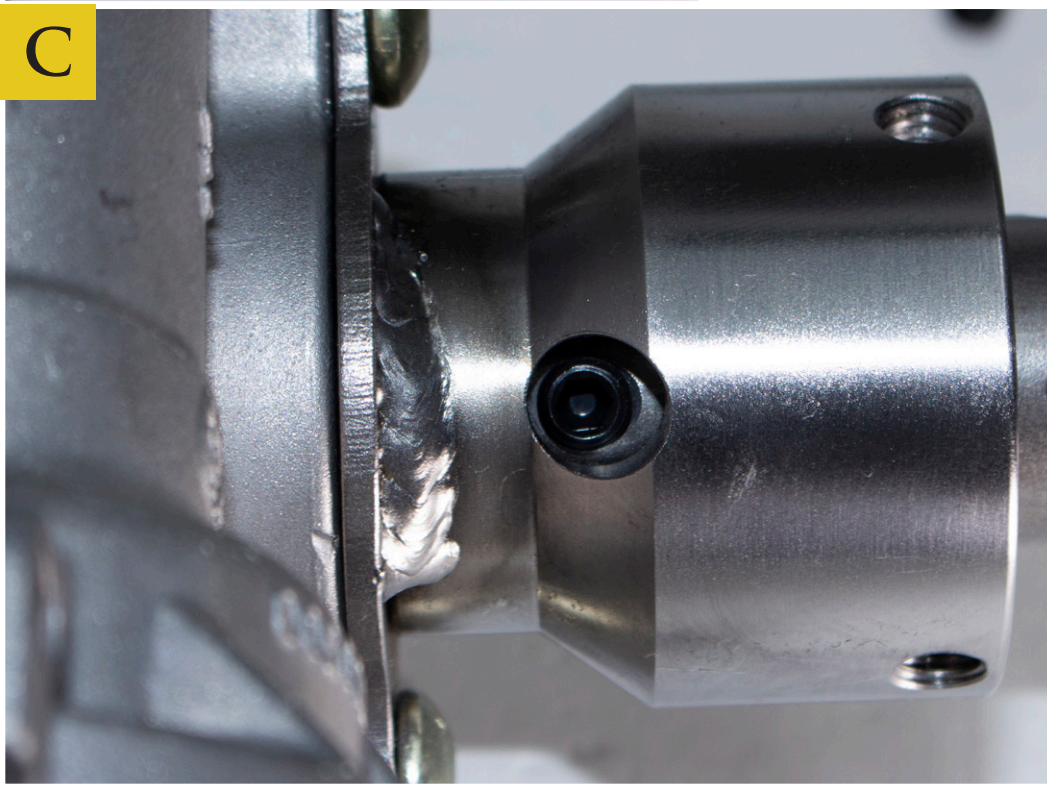
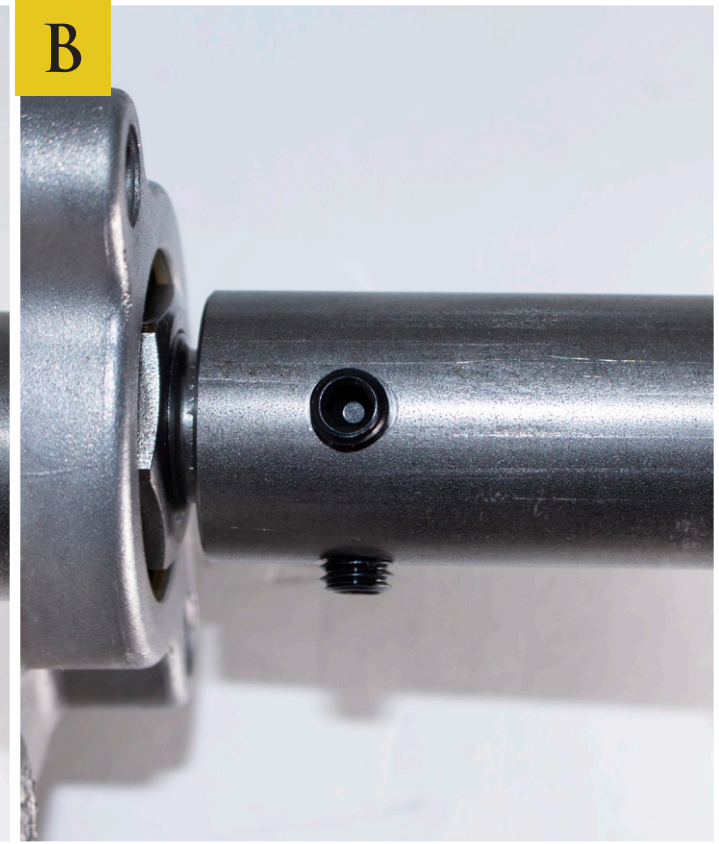
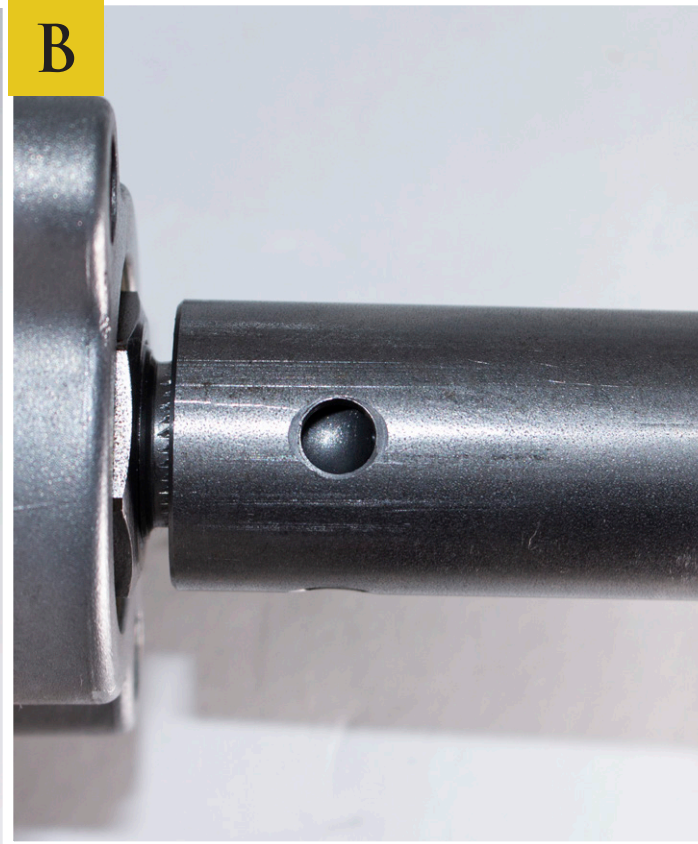
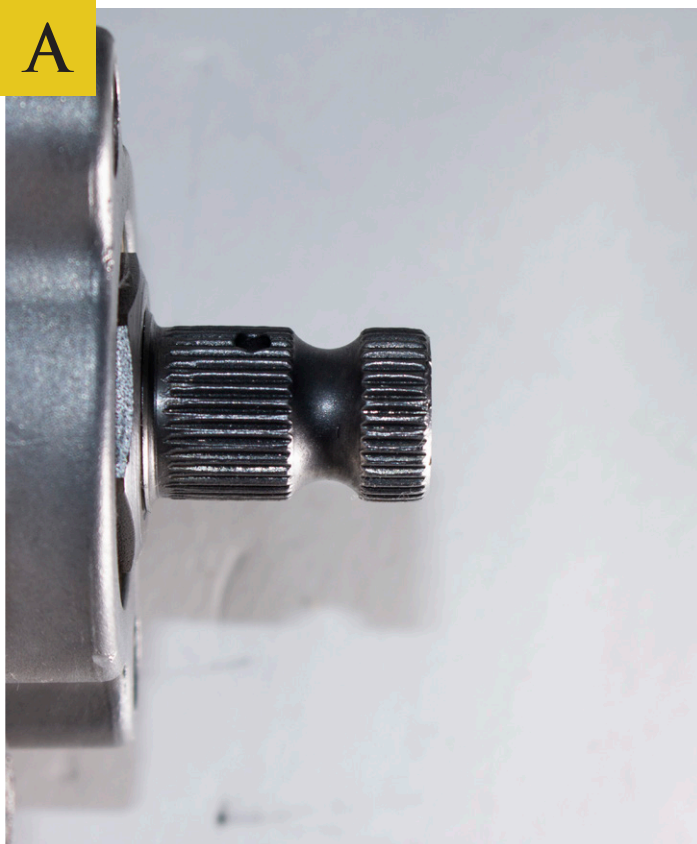

### Column and Motor Assembly:

When mounting the EPAS motor to the lower column, ensure the splined coupler it is fully seated and tighten the spline setscrews. (Setscrews should be seated in the section between the two sets of splines.)

Both setscrews can be accessed through this hole by simply turning the steering shaft where the steering wheel mounts.





## External Shift Rod Modification:

Modifications will need to be made to the shift shaft to bend around the EPAS motor. Keep in mind the 12:00 position for the shifter to attach to the steering box side.

Install the shift stalk and roll pin. Install the steering box back into the vehicle, only install one bolt. This allows for movement in the upper portion install.

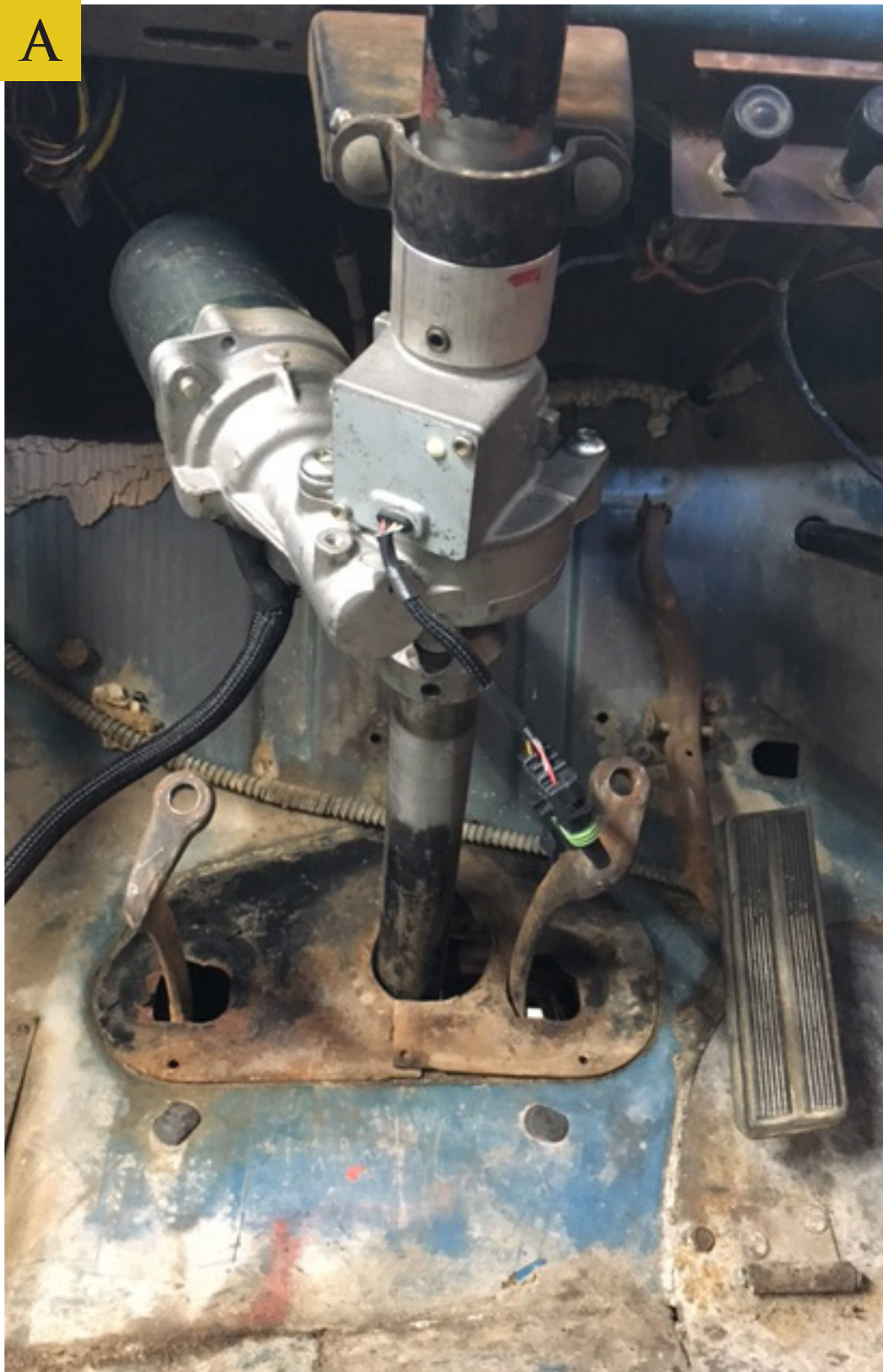

## Steering Wheel and Column Installation:

Reassemble the turn signal assembly.

Re-run the wires, ensure the turn signal assemble is at 12:00 or top dead center. Install the column tube into the EPAS motor adapter, tightening all setscrews.

Reinstall the column bracket securing the column to the dash of the vehicle.



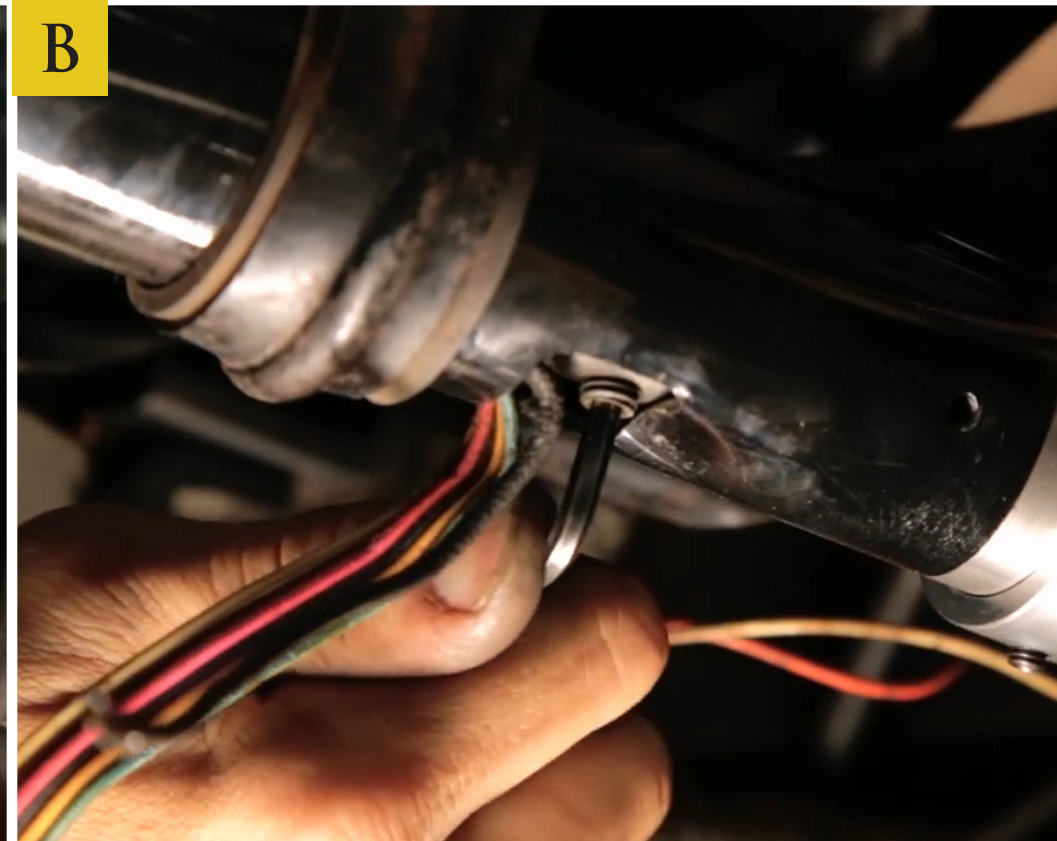
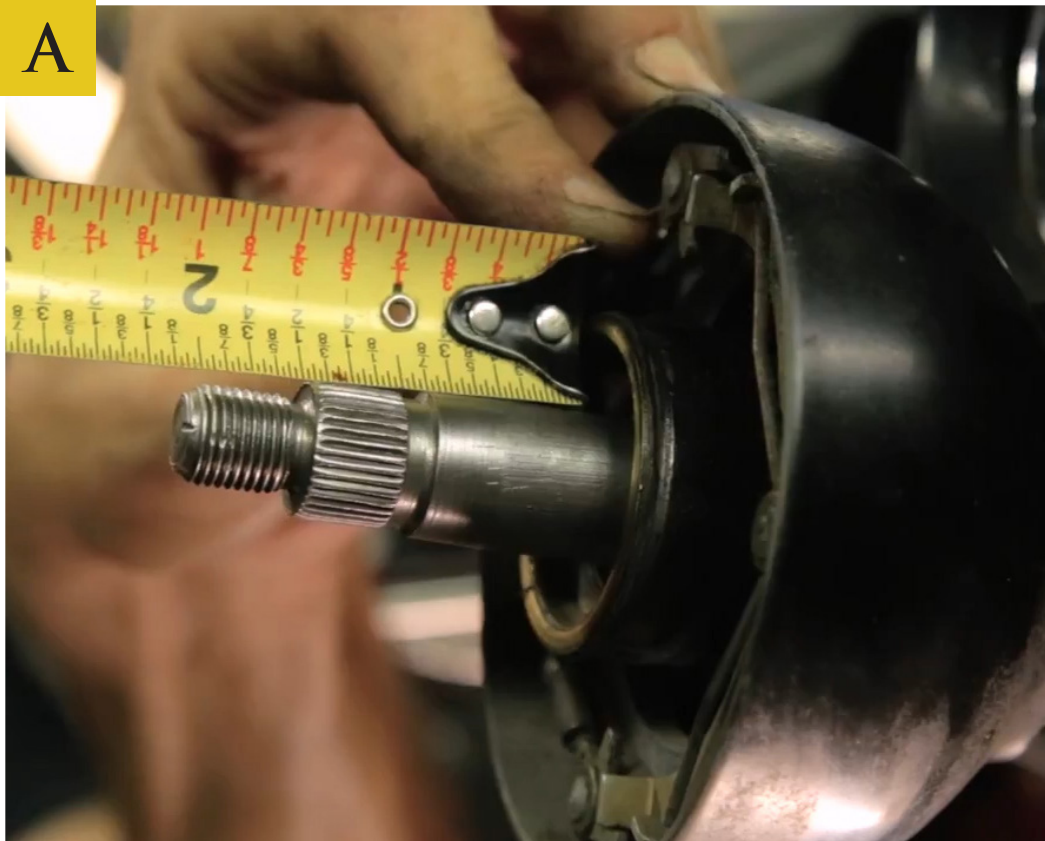

## Steering Wheel and Column Installation:

Install the steering shaft into the column tube and into the EPAS motor shaft adapter. Ensure the steering shaft is fully seated in the DD coupler. 1 1/2" of the shaft should extend out of the steering column to mount the steering wheel. Adjust the steering shaft as needed to achieve this measurement by loosening the setscrews and pushing or pulling the shaft through the wire exit hole.

Once the steering shaft is in the proper placement, tighten all setscrews.

Mount the steering wheel.

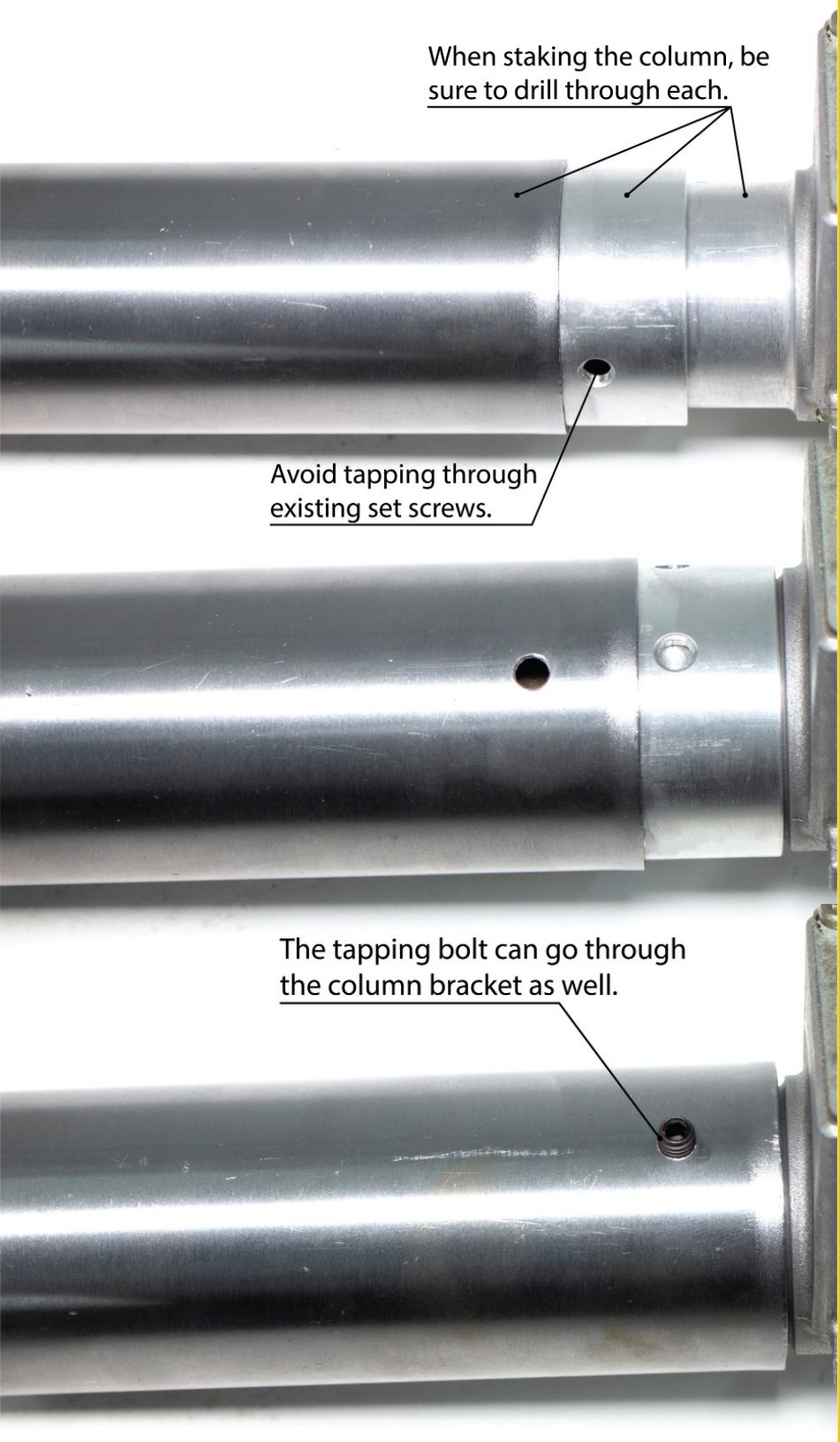

When staking the column, be sure to drill through each.

Avoid tapping through existing set screws.

The tapping bolt can go through the column bracket as well.

## STAKING COLUMN:

For added stability, the column tube and motor housing can be “staked” in place to reduce the possibility of the system spinning in the vehicle. This process is suggested but not required.

To begin the staking process you will first need to clock the motor to the correct position and mark the column. Once the steering column is in place, the motor should sit between 9 and 11 O’clock position. The motor has 360° clockability to allow for an adjustable fit if the suggested position does not work.

Drill a hole through the column tube and the aluminum collar (attached to the motor) tapping the motor housing. (“Tapping” the motor housing is making a dent in the housing to ensure the bolt being used will rest in the dent) Stake the column in place using ¼-20 bolt to “sandwich” all three together.

Ensure the screw length is no more than 10mm, if it is too long it can bind the shaft. You can drill through the motor housing for additional security (**BE SURE NOT TO DRILL OR TAP INTO THE MOTOR SHAFT**).



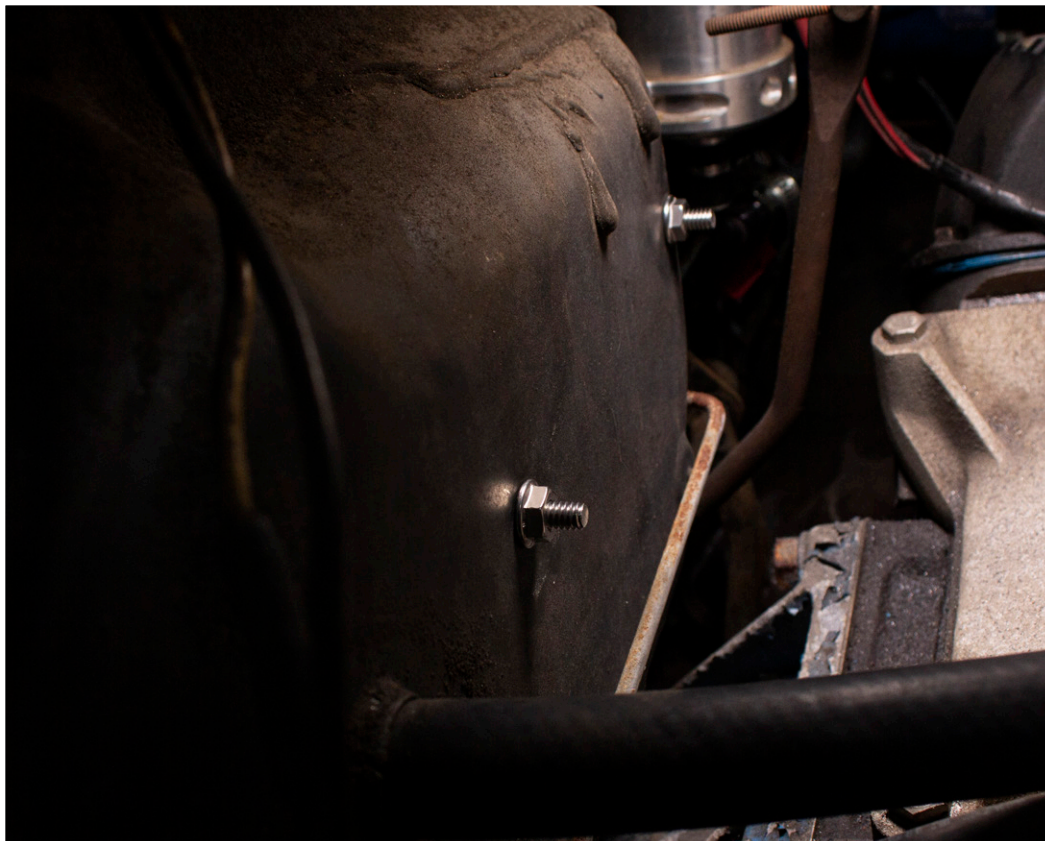

## Control Module Installation:

Install the pre-wired control module and its wiring. Location inside the vehicle is at builders discretion. The recommended install location is behind the center console. A hole will need to be drilled in the firewall of the vehicle. This hole will need to be  $\frac{3}{4}$ " (19mm) in diameter. The position of this hole should be next to the existing hole for the vehicles main wiring harness. This hole will be used to run the red and black battery wires. Install the provided rubber grommet.

Ensure both ground wires are properly connected to the module plate before mounting.

Connect the plug from the motor (**Blue Connector**) to the module. Connect the plug for the torque sensor (**4way**) to the module.



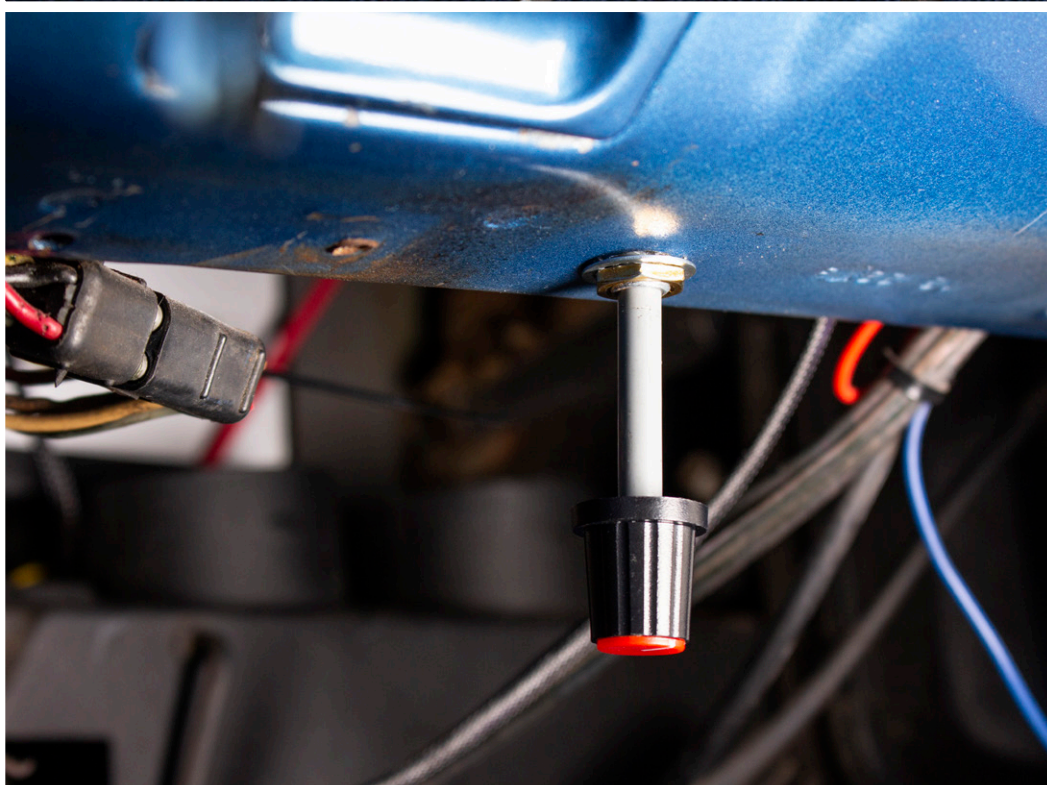
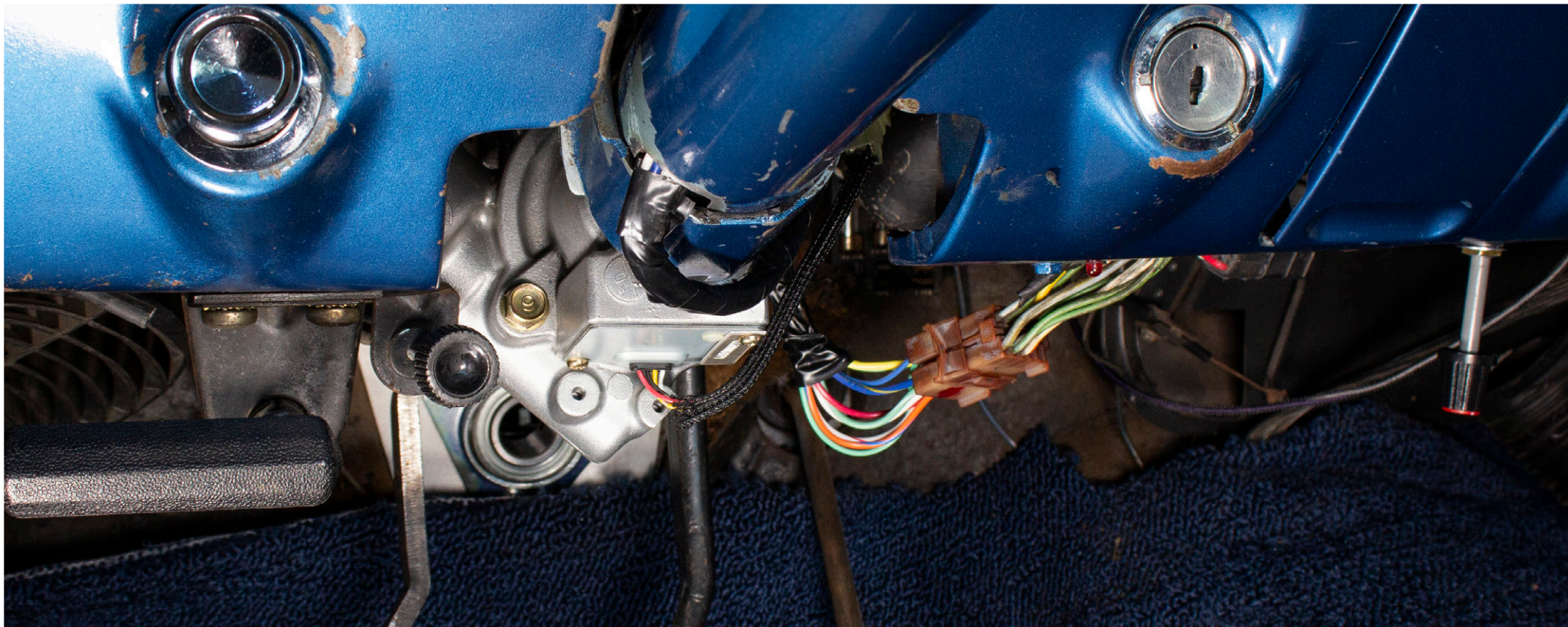

## Power Wires & Potentiometer Installation:

Reconnect the column wiring harness to the vehicle.

Hook up the small red wire to a hot in run and the #10 red and black wire directly to your battery or a direct power and ground source.

Install potentiometer in an accessible location. This potentiometer allows you to adjust the strength of the assistance provided by the system. When turned fully clockwise the system will be set to maximum. Turning the dial counter clockwise will reduce the amount of assistance until none is being provided. Your steering will have returned to its original resistance; however, the system will not be completely powered down until the vehicle itself is turned off.



# Module Wiring Diagram

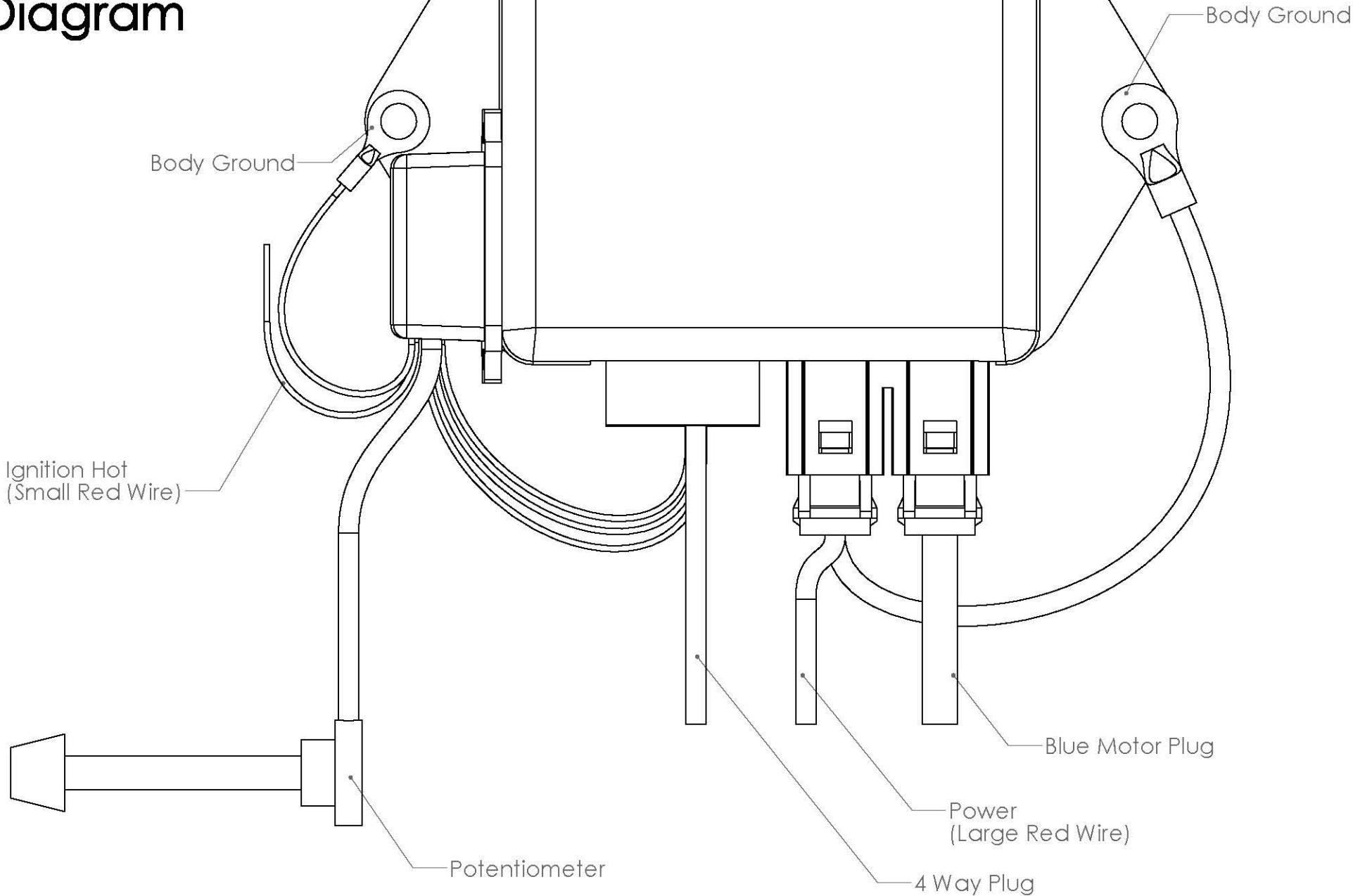

# TERMS AND CONDITIONS

## LIABILITY LIMITATION AND RELEASE

We are pleased you have chosen to purchase one of our automotive specialty equipment items. Our products are carefully designed to combine performance, durability and safety, and to work in concert with the vehicle's original equipment. As they are specialty products, however, and as both performance and safety are paramount concerns, we urge our customers to consider having the products professionally installed.

We caution the purchaser that the enhancement provided by the specialty equipment item may change the handling characteristics of the vehicle. We urge the purchaser to carefully familiarize him/herself with the vehicle's performance characteristics with the new equipment. This should be done in a safe environment and in a safe manner.

We have no control over the quality or correctness of equipment installations performed by others, nor can we control the uses (in manner or environment) products are subjected to. Accordingly, liability on the part of EPAS Performance LLC is limited to the terms of its Express Limited Warranty.

A decision by the purchaser to retain and install the item purchased will be deemed acceptance of the specific terms of this Liability Limitation and Release.

The purchaser expressly releases and waives any claim against us for any consequential damages or injury that may arise from the use, or any malfunction, of its product. This Liability Limitation and Release binds the original purchaser, all successors in interest, and all persons to whom the product may subsequently be transferred; and the purchaser agrees to make this limitation known to all such persons. This Liability Limitation and Release is part of the consideration for the sale of the product.

This Liability Limitation and Release is governed by the laws of the State of Florida, United States of America. Any dispute regarding its terms or application is subject to arbitration in the State of Florida at the request of either party to the sale.

## WARRANTY

This warranty is limited to the repair or replacement of the defective part only; the warranty specifically excludes labor or consequential damages or injury. The decision as to whether the defective part will be repaired or replaced will rest solely with the manufacturer. The warranty period begins on the date the product is shipped to you.

Full 5-year warranty nontransferable.

This warranty is void if the product is or was improperly installed, abused in any manner. Road or accident damage is not covered.

To make a claim under this warranty, call EPAS Performance to return the defective product, shipping or postage prepaid. Please include a copy of the original purchase invoice and a note describing the circumstances of the failure or malfunction.

This warranty is governed by the laws of the State of Florida, United States of America. Any dispute regarding the coverage of this warranty, its application or terms is subject to arbitration in the State of Florida.

If the purchaser disagrees with any of the terms of this warranty, please return the purchased item within three (3) business days of receipt. A decision by the purchaser to retain and install the item purchased will be deemed acceptance of the specific terms of this warranty.



Thank you for purchasing the EPAS Performance electric power system.  
We do hope you enjoy your vehicle for many miles to come.

