

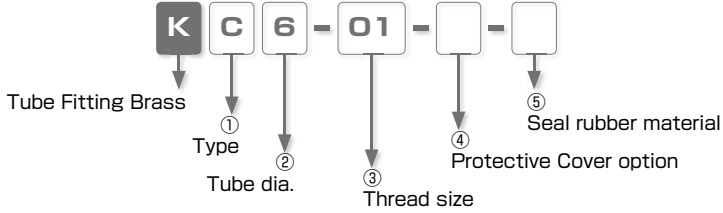

Brass Push-In Fitting Type for Spatter-Proof Tube Fitting **Brass Series**

- *HNBR, FKM, NBR for Seal Rubber Selection*
- *Resistant to Flame and Weld Spatter*
- *Superior in Flame-Retardant and Spatter-Proof by its Brass Made Release-Ring*
- *Avoiding Spatter and Dusts by Protective Cover*
- *Optional Release-Ring Cover "CS" prevents Tiny Sparks from penetrating into Fitting*
Optional release-ring cover keeps tiny sparks away from penetrating through the gap between release-ring and tube.

Model Designation (Example)



① Type

Code	Type	Code	Type	Code	Type	Code	Type
C	Straight	OC	Inner Hex. Straight	L	Elbow	B	Branch Tee
D	Run Tee	H	Single Banjo	U	Union Straight	V	Union Elbow
E	Union Tee	Y	Union Y	M	Bulkhead Union		

② Tube dia.

Tube dia.	mm size				
Code	4	6	8	10	12
Size (mm)	ø4	ø6	ø8	ø10	ø12

③ Thread size

Thread size	Metric thread (mm)	Taper pipe thread			
Code	M5	O1	O2	O3	O4
Size	M5 × 0.8	R1/8	R1/4	R3/8	R1/2

④ Protective Cover option

No code : with cover

1 : without cover

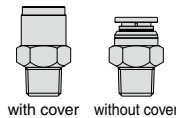

⑤ Seal rubber material

No code : HNBR

F : FKM (option)

N : NBR (option)

Specifications

Fluid medium	Air / Water (※)
Max. operating pressure	1.0MPa
Max. vacuum	-100kPa
Operating temp. range	HNBR : 0 ~ 100℃, FKM : 0 ~ 120℃, NBR : 0 ~ 60℃ (No freezing)

△ Warning

※ . Make sure to follow the instructions below when the fluid medium is water.

1. Surge pressure must be controlled lower than max. operating pressure when using water as a fluid medium.
2. Be sure to place Insert Ring into the tube edge when using water as a fluid medium. There is a possibility to cause the escape of tube and a fluid leakage without Insert Ring.

Construction (Elbow: KL HNBR with cover)

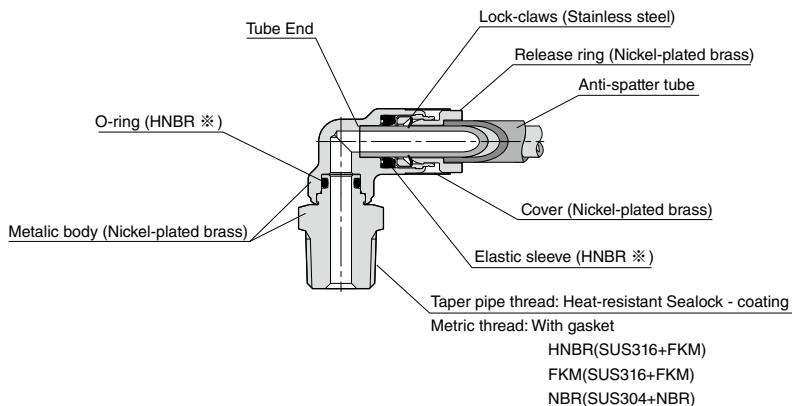

※. FKM when selecting "F" for Seal rubber material, NBR when selecting "N".

△ Detailed Safety Instructions

Before using PISCO products, be sure to read "Safety Instructions" and "Safety Instruction Manual" on page 23 to 27 and "Common Safety Instructions for Fittings" on page 33 to 35.

Warning

1. When the fluid medium is water, do not use Tube Fitting Brass series unless the operating environment meets all the described specifications in the catalog. Otherwise, it may cause damage to the products, the escape of tubes and a fluid leakage.
2. Tube fitting Brass Series has seal rubber material options, but there is no way to identify between each material. Store each product properly not to mix up, after opening their packages.
3. Thread body of some types in Tube Fitting Brass series is rotatable. Do not rotate and swing it by force or continuously. It may cause damage to the products and a fluid leakage.
4. Select seal rubber material considering sufficient margin to the operating temperature range. Seal rubber material can be worn out by heat and may cause a fluid leakage. Perform maintenance periodically and in case leaks are found, replace the product to the new one promptly.

Caution

1. When using Anti-spatter Tube, peel the cover as the following table shows. It may cause the escape of a tube, a fluid leakage or make it impossible to insert the tube into Push-In Fitting, if the tube is not peeled properly.

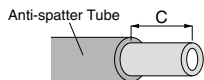

Tube dia.	∅ 4mm	∅ 6mm	∅ 8mm	∅ 10mm	∅ 12mm
Peeled length (C)	15mm	16mm	17mm	19.5mm	23mm

Standard Size List

Connection: Thread ⇔ Tube

Type	Page	Thread size	Tube O.D. (mm)				
			4	6	8	10	12
KC Straight	P.217	M5 × 0.8	●	●	●	●	●
		R1/8	●	●	●	●	●
		R1/4	●	●	●	●	●
		R3/8	●	●	●	●	●
		R1/2	●	●	●	●	●
KOC Inner Hex. Straight	P.219	M5 × 0.8	●	●	●	●	●
		R1/8	●	●	●	●	●
		R1/4	●	●	●	●	●
		R3/8	●	●	●	●	●
		R1/2	●	●	●	●	●
KL Elbow	P.221	M5 × 0.8	●	●	●	●	●
		R1/8	●	●	●	●	●
		R1/4	●	●	●	●	●
		R3/8	●	●	●	●	●
		R1/2	●	●	●	●	●

Type	Page	Thread size	Tube O.D. (mm)				
			4	6	8	10	12
KB Branch Tee	P.223	M5 × 0.8	●	●	●	●	●
		R1/8	●	●	●	●	●
		R1/4	●	●	●	●	●
		R3/8	●	●	●	●	●
		R1/2	●	●	●	●	●
KD Run Tee	P.225	M5 × 0.8	●	●	●	●	●
		R1/8	●	●	●	●	●
		R1/4	●	●	●	●	●
		R3/8	●	●	●	●	●
		R1/2	●	●	●	●	●
KH Single Banjo	P.227	M5 × 0.8	●	●	●	●	●
		R1/8	●	●	●	●	●
		R1/4	●	●	●	●	●
		R3/8	●	●	●	●	●
		R1/2	●	●	●	●	●

Connection: Tube ⇔ Tube (Equal dia.)

Type	Page	Tube O.D. (mm)				
		4	6	8	10	12
KU Union Straight	P.229	●	●	●	●	●
KV Union Elbow	P.230	●	●	●	●	●
KE Union Tee	P.231	●	●	●	●	●

Type	Page	Tube O.D. (mm)				
		4	6	8	10	12
KM Bulkhead Union	P.232	●	●	●	●	●
KY Union Y	P.233	●	●	●	●	●

How to insert and disconnect

1. How to insert and disconnect tubes

① Tube insertion

Insert a tube into Push-In Fitting Brass series up to the tube end. Lock-claws bite the tube and fix it automatically, then the elastic sleeve seals around the tube.

Refer to "2. Instructions for Tube Insertion" under "Common Safety Instructions for Fittings".

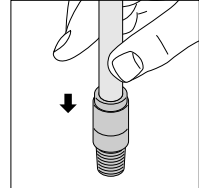

② Tube disconnection

The tube is disconnected by pushing release-ring to release Lock-claws. Make sure to stop air supply before the tube disconnection.

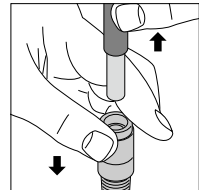

2. How to tighten thread

① Tightening thread

There are two ways to tighten thread. Use a spanner or an impact wrench for a hexagonal-column. A hex key is for an inner hexagonal socket. Inner hex type can save spaces.

Refer to "Table 2: Recommended tightening torque / Sealock color / Gasket materials" under "4. Instructions for Installing a fitting" in "Common Safety Instructions for Fittings".

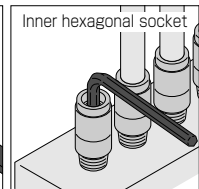
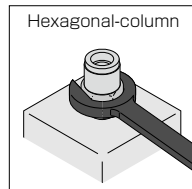

3. How to install Release-ring cover

Attach the cover on release-ring of Brass Series and insert a tube.

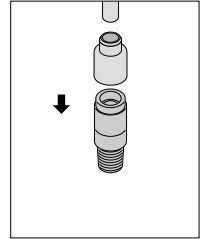

FITTING

CONTROLLER

VALVE

TUBE

MAKE-TO-ORDER PRODUCTS

216

■ Applicable Tube and Related Products

Anti-spatter Tube.....P.646

Tube Fitting Anti-spatter Series.....P.204

Speed Controller Anti-spatter.....P.422

Speed Controller Brass.....P.430

Throttle (Needle) Valve Brass.....P.474

Anti-spatter
& Brass Series

Oil Temperature
Control

Minimal
Series

Stop Fitting
Series

Rotary
Series

Twist-Proof
Fitting

Block and
Connector

Coupling

Color
Cap

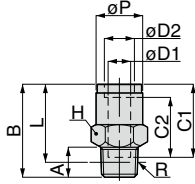

Taper pipe thread

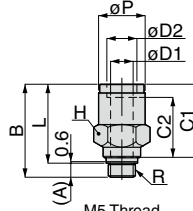

M5 Thread

Unit : mm

Model code	Tube O.D. $\phi D1$	Tube O.D. $\phi D2$	R	ϕP	B	Tube end C1	Tube end C2	A	L	Hex. H	Orifice dia.	Effective area (mm ²)	Weight (g)
KC4-M5-□	4	6	M5×0.8	9.8	22.7	17.6	15	2.9	19.8	10	1.8	2	12
KC4-01-□			R1/8		23.7			8	19.7				
KC4-02-□			R1/4		26.7			11	20.7		14		
KC6-M5-□	6	8	M5×0.8	11.8	25.5	19.5	16.3	2.9	22.6	12	1.8	2	17
KC6-01-□			R1/8		25.1			8	21.1				
KC6-02-□			R1/4		29.1			11	23		14		
KC6-03-□			R3/8		29.1			12	22.7	17	34		
KC8-01-□	8	10	R1/8	13.8	29.9	20.2	17.2	8	25.9	14	6	20	27
KC8-02-□			R1/4		28.6			11	22.6				
KC8-03-□			R3/8		28.9			12	22.6		17	32	
KC10-01-□	10	12	R1/8	16.9	33.3	23.2	19.5	8	29.3	17	6	23	40
KC10-02-□			R1/4					31.8	11				
KC10-03-□			R3/8		12				25.5		22	8.5	47
KC10-04-□			R1/2		35.8			15	27.6	22			
KC12-02-□	12	14	R1/4	20	38.9	26.3	22.3	11	32.9	21	8.5	47	62
KC12-03-□			R3/8		34.9			12	28.6				
KC12-04-□			R1/2		36.9			15	28.7	22	74		

※ 1. "L" is a reference value for height dimension after tightening taper thread.

※ 2. □ in Model code / Replaced with "N"(NBR), or "F"(FKM) for Seal rubber material change



Straight without cover

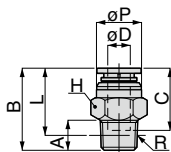

Taper pipe thread

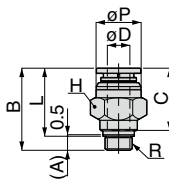

M5 Thread

Unit : mm

Model code	Tube O.D. øD	R	øP	B	Tube end C	A	L	Hex. H	Orifice dia.	Effective area (mm ²)	Weight (g)
KC4-M5-1-□	4	M5 × 0.8	9.9	19.6	14.5	2.9	16.7	10	1.8	2	10
KC4-01-1-□		R1/8		20.6		8	16.6				
KC4-02-1-□		R1/4		23.6		11	17.6	14			
KC6-M5-1-□	6	M5 × 0.8	11.8	22.6	16.6	2.9	19.7	12	1.8	2	15
KC6-01-1-□		R1/8		22.2		8	18.2				
KC6-02-1-□		R1/4		26.2		11	20.1	14	4	11	
KC6-03-1-□		R3/8		26.2		12	19.8	17			
KC8-01-1-□	8	R1/8	13.8	27.4	17.7	8	23.4	14	6	20	25
KC8-02-1-□		R1/4		26.1		11	20.1				17
KC8-03-1-□		R3/8		26.4		12	20.1	17			30
KC10-01-1-□	10	R1/8	16.8	30.1	20	8	26.1	17	6	23	35
KC10-02-1-□		R1/4				11	24.1				
KC10-03-1-□		R3/8		12		22.3	8	35	41		
KC10-04-1-□		R1/2		15		24.4				22	62
KC12-02-1-□	12	R1/4	19.8	35.2	22.6	11	29.2	21	8.5	47	53
KC12-03-1-□		R3/8		12		24.9	21				
KC12-04-1-□		R1/2		33.2		15	25	22	9	50	66

※ 1. "L" is a reference value for height dimension after tightening taper thread.

※ 2. □ in Model code / Replaced with "N" (NBR), or "F" (FKM) for Seal rubber material change

FITTING
 CONTROLLER
 VALVE
 TUBE
 MAKE-TO-ORDER
 PRODUCTS

218

Anti-siphon
 & Press Series
 Oil Temperature
 Control
 Minimal
 Series
 Stop Fitting
 Series
 Rotary
 Series
 Twist-Proof
 Fitting
 Block and
 Connector
 Coupling

Color
 Cap

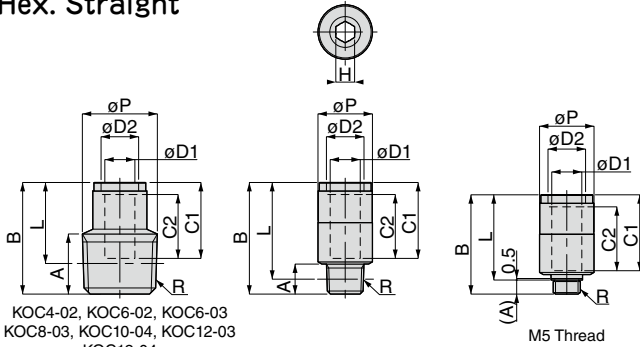

Unit : mm

Model code	Tube O.D. øD1	Tube O.D. øD2	R	øP	B	Tube end C1	Tube end C2	A	L	Hex. H	Orifice dia.	Effective area (mm ²)	Weight (g)
KOC4-M5-□	4	6	M5×0.8	9.9	22.6	17.6	15	2.9	19.7	2	2.1	2	11
KOC4-01-□			R1/8		23.7			8					
KOC4-02-□			R1/4		24.7			11					
KOC6-M5-□	6	8	M5×0.8	11.9	25.5	19.5	16.3	2.9	22.6	2	2.1	2	15
KOC6-01-□			R1/8		25.1			8					
KOC6-02-□			R1/4		26.1			11					
KOC6-03-□			R3/8		26.1			12					
KOC8-01-□			R1/8		29.9			8					
KOC8-02-□	R1/4	13.9	28.6	11									
KOC8-03-□	R3/8	16.9	25.9	12									
KOC10-01-□	10	12	R1/8	16.9	33.3	23.2	19.5	8	29.3	5	5.1	17	35
KOC10-02-□			R1/4		32.3			11					
KOC10-03-□			R3/8		31.8			12					
KOC10-04-□			R1/2		32.8			15					
KOC12-02-□	12	14	R1/4	20.8	38.9	26.3	22.3	11	32.9	8	8.2	40	56
KOC12-03-□			R3/8		34.9			12					
KOC12-04-□			R1/2		36.9			15					

※ 1. "L" is a reference value for height dimension after tightening taper thread.

※ 2. □ in Model code / Replaced with "N"(NBR), or "F"(FKM) for Seal rubber material change

KOC Inner Hex. Straight without cover

OP
P.754

RoHS compliant

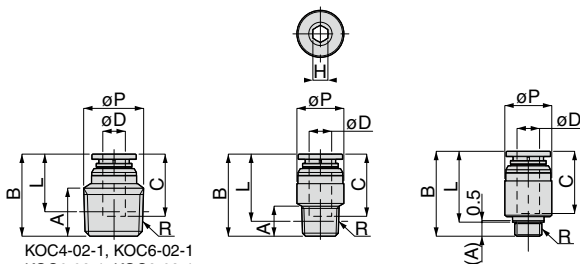

KOC4-02-1, KOC6-02-1
KOC6-03-1, KOC8-03-1
KOC10-04-1, KOC12-03-1
KOC12-04-1

M5 Thread

Unit : mm

Model code	Tube O.D. øD	R	øP	B	Tube end C	A	L	Hex. H	Orifice dia.	Effective area (mm ²)	Weight (g)
KOC4-M5-1-□	4	M5 × 0.8	9.9	19.5	14.5	2.9	16.6	2	2.1	2	10
KOC4-01-1-□		R1/8		20.6		8					
KOC4-02-1-□		R1/4	14	21.6		11	15.6				
KOC6-M5-1-□	6	M5 × 0.8	11.9	22.6	16.6	2.9	19.7	2	2.1	2	13
KOC6-01-1-□		R1/8		22.2		8					
KOC6-02-1-□		R1/4	13.9	21.6		11	16.1				
KOC6-03-1-□		R3/8	16.9	23.2		12	16.8				
KOC8-01-1-□	8	R1/8	13.9	27.4	17.7	8	23.4	5	5.1	17	18
KOC8-02-1-□		R1/4		26.1		11					
KOC8-03-1-□		R3/8	16.9	23.4		12	17.1				
KOC10-01-1-□	10	R1/8	16.9	30.1	20	8	26.1	5	5.1	17	31
KOC10-02-1-□		R1/4		29.1		11					
KOC10-03-1-□		R3/8		28.6		12	22.3				
KOC10-04-1-□		R1/2	20.8	29.6		15	21.4				
KOC12-02-1-□	12	R1/4	20.8	35.2	22.6	11	29.2	8	8.2	40	48
KOC12-03-1-□		R3/8		31.2		12					
KOC12-04-1-□		R1/2	33.2	15		25					

※ 1. "L" is a reference value for height dimension after tightening taper thread.

※ 2. □ in Model code / Replaced with "N"(NBR), or "F"(FKM) for Seal rubber material change

FITTING
CONTROLLER
VALVE
TUBE
MAKE-TO-ORDER
PRODUCTS
220
Anti-suction
& Press Series
Oil Temperature
Control
Minimal
Series
Stop Fitting
Series
Rotary
Series
Twist-Proof
Fitting
Block and
Connector
Coupling
Color
Cap

KL Elbow

RoHS compliant

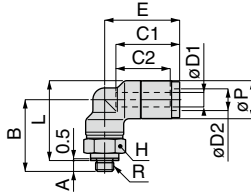

Metric thread

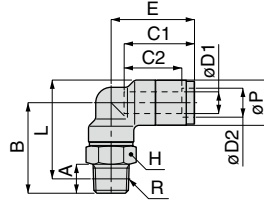

Taper pipe thread

Unit : mm

Model code	Tube O.D. øD1	Tube O.D. øD2	R	A	B	L	øP	Tube end C1	Tube end C2	E	Hex. H	Orifice dia.	Weight (g)	Effective area (mm ²)
KL4-M5-□	4	6	M5×0.8	3	19.8	22	10.5	17.6	15	20.7	10	1.8	18	1.5
KL4-01-□			R1/8	8	22.8	24.1					2.5	21	3.5	
KL4-02-□			R1/4	11	25.8	25					31			
KL6-M5-□	6	8	M5×0.8	3	22	25.3	12.5	19.4	16	23	12	1.8	26	1.9
KL6-01-□			R1/8	8	25	27.3					4	28	9	
KL6-02-□			R1/4	11	28	28.2						36		
KL6-03-□			R3/8	12	29.8	29.7						49		
KL8-01-□	8	10	R1/8	8	28	31.3	14.5	20.2	17	24.8	14	6	36	16
KL8-02-□			R1/4	11	31	32.2					41			
KL8-03-□			R3/8	12	32.8	33.7					55			
KL10-01-□	10	12	R1/8	8	32.5	37.8	18.6	23.2	19.5	29.3	17	6	67	22.5
KL10-02-□			R1/4	11	35.5	38.8					8	69	30	
KL10-03-□			R3/8	12	38.5	39.5						78		
KL10-04-□			R1/2	15	39.5	40.6						104		
KL12-02-□	12	14	R1/4	11	37.5	42.3	21.6	26.3	23	33.4	21	8	107	38
KL12-03-□			R3/8	12	38.5	43					9	113	39	
KL12-04-□			R1/2	15	41.5	44.1						129		

※ 1. "L" is a reference value for height dimension after tightening taper thread.

※ 2. □ in Model code / Replaced with "N"(NBR), or "F"(FKM) for Seal rubber material change

KL Elbow without cover

NO COVER

RoHS compliant

OP
P.754

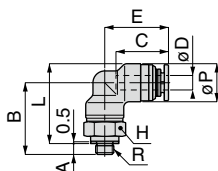

Metric thread

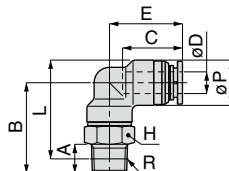

Taper pipe thread

Unit : mm

Model code	Tube O.D. øD	R	A	B	L	øP	Tube end C	E	Hex. H	Orifice dia.	Weight (g)	Effective area (mm ²)	
KL4-M5-1-□	4	M5×0.8	3	19.8	22	10.5	14.5	17.6	10	1.8	17	1.5	
KL4-01-1-□		R1/8	8	22.8	24.1					2.5	20	3.5	
KL4-02-1-□		R1/4	11	25.8	25					14	29		
KL6-M5-1-□	6	M5×0.8	3	22	25.3	12.5	16.5	20.1	12	1.8	24	1.9	
KL6-01-1-□		R1/8	8	25	27.3					4	27	9	
KL6-02-1-□		R1/4	11	28	28.2						35		
KL6-03-1-□		R3/8	12	29.8	29.7						17		47
KL8-01-1-□	8	R1/8	8	28	31.3	14.5	17.7	22.3	14	6	34	16	
KL8-02-1-□		R1/4	11	31	32.2						40		
KL8-03-1-□		R3/8	12	32.8	33.7						17		53
KL10-01-1-□	10	R1/8	8	32.5	37.8	18.5	20	26.1	17	6	62	22.5	
KL10-02-1-□		R1/4	11	35.5	38.7						8		64
KL10-03-1-□		R3/8	12	36.5	39.4								73
KL10-04-1-□		R1/2	15	39.5	40.6					22	99		
KL12-02-1-□	12	R1/4	11	37.5	42.2	21.5	22.6	29.7	21	8	100	38	
KL12-03-1-□		R3/8	12	38.5	42.9						9		106
KL12-04-1-□		R1/2	15	41.5	44.1					22	121	39	

※ 1. "L" is a reference value for height dimension after tightening taper thread.

※ 2. □ in Model code / Replaced with "N"(NBR), or "F"(FKM) for Seal rubber material change

FITTING
CONTROLLER
VALVE
TUBE
MAKE-TO-ORDER
PRODUCTS

222

Anti-siphon
& Press Series
Oil Temperature
Control
Minimal
Series
Stop Fitting
Series
Rotary
Series
Twist-Proof
Fitting
Block and
Connector
Coupling

Color
Cap

KB Branch Tee

RoHS compliant

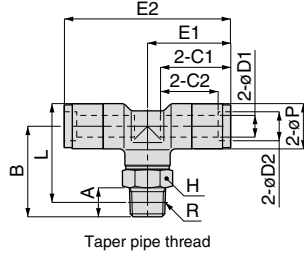
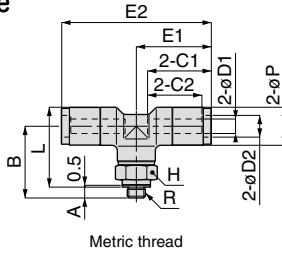

Unit : mm

Model code	Tube O.D. φD1	Tube O.D. φD2	R	A	B	L	E1	E2	φP	Tube end C1	Tube end C2	Hex. H	Orifice dia.	Weight (g)	Effective area (mm ²)
KB4-M5-□	4	6	M5×0.8	3	19.8	22	20.7	41.4	10.5	17.6	15	10	1.8	26	15
KB4-01-□			R1/8	8	22.8	24.1							2.5	29	
KB4-02-□			R1/4	11	25.8	25							14	38	
KB6-M5-□	6	8	M5×0.8	3	22	25.3	23	46.1	12.5	19.4	16	12	1.8	36	1.5
KB6-01-□			R1/8	8	25	27.3							4	38	
KB6-02-□			R1/4	11	28	28.2							14	46	
KB6-03-□			R3/8	12	29.8	29.7							17	59	
KB8-01-□	8	10	R1/8	8	28	31.3	24.8	49.6	14.5	20.2	17	14	6	48	19
KB8-02-□			R1/4	11	31	32.2							17	54	
KB8-03-□			R3/8	12	32.8	33.7							17	67	
KB10-01-□	10	12	R1/8	8	32.5	37.8	29.3	58.6	18.6	23.2	19.5	17	6	90	23
KB10-02-□			R1/4	11	35.5	36.8							8	93	
KB10-03-□			R3/8	12	36.5	39.5							8	101	
KB10-04-□			R1/2	15	39.5	40.6							22	128	
KB12-02-□	12	14	R1/4	11	37.5	42.3	33.4	66.8	21.6	26.3	23	21	8	147	40
KB12-03-□			R3/8	12	38.5	43							9	153	
KB12-04-□			R1/2	15	41.5	44.1							22	169	

※ 1. "L" is a reference value for height dimension after tightening taper thread.

※ 2. □ in Model code / Replaced with "N"(NBR), or "F"(FKM) for Seal rubber material change



Branch Tee without cover



RoHS compliant

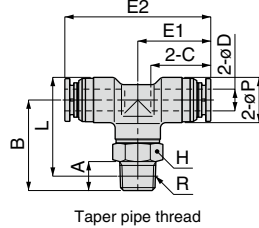
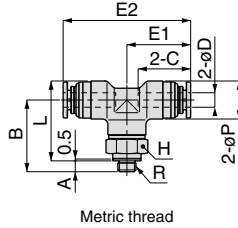

Unit : mm

Model code	Tube O.D. øD	R	A	B	L	E1	E2	øP	Tube end C	Hex. H	Orifice dia.	Weight (g)	Effective area (mm ²)	
KB4-M5-1-□	4	M5 × 0.8	3	19.8	22	17.6	35.2	10.5	14.5	10	1.8	23	1.5	
KB4-01-1-□		R1/8	8	22.8	24.1					14	2.5	26		4.1
KB4-02-1-□		R1/4	11	25.8	25					14	3.5	35		
KB6-M5-1-□	6	M5 × 0.8	3	22	25.3	20.1	40.3	12.5	16.5	12	1.8	33	1.5	
KB6-01-1-□		R1/8	8	25	27.3					12	3.5	10		
KB6-02-1-□		R1/4	11	28	28.2					14	4			43
KB6-03-1-□		R3/8	12	29.8	29.7					17	5.6			56
KB8-01-1-□	8	R1/8	8	28	31.3	22.3	44.6	14.5	17.7	14	6	44	19	
KB8-02-1-□		R1/4	11	31	32.2					14	6	50		
KB8-03-1-□		R3/8	12	32.8	33.7					17	6.3	63		
KB10-01-1-□	10	R1/8	8	32.5	37.8	26.1	52.2	18.5	20	17	6	80	23	
KB10-02-1-□		R1/4	11	35.5	38.7					17	8.3	35		
KB10-03-1-□		R3/8	12	36.5	39.4					8	9.1			
KB10-04-1-□		R1/2	15	39.5	40.8					22	11.8			
KB12-02-1-□	12	R1/4	11	37.5	42.2	29.7	59.4	21.5	22.6	21	8	132	40	
KB12-03-1-□		R3/8	12	38.5	42.9					21	9	138		
KB12-04-1-□		R1/2	15	41.5	44.1					22	15.4	154		

※ 1. "L" is a reference value for height dimension after tightening taper thread.

※ 2. □ in Model code / Replaced with "N"(NBR), or "F"(FKM) for Seal rubber material change

FITTING CONTROLLER VALVE TUBE MAKE-TO-ORDER PRODUCTS

224

Anti-siphon & Press Series
On Temperature Control
Minimal Series
Stop Fitting Series
Rotary Series
Twist-Proof Fitting
Block and Connector
Coupling

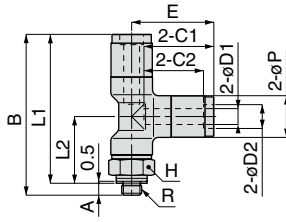

Metric thread

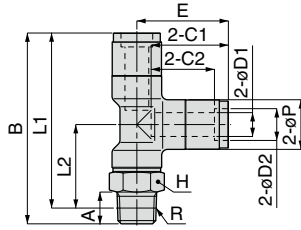

Taper pipe thread

Unit : mm

Model code	Tube O.D. øD1	Tube O.D. øD2	R	A	B	L1	L2	øP	Tube end C1	Tube end C2	E	Hex. H	Orifice dia.	Weight (g)	Effective area (mm ²)
KD4-M5-□	4	6	M5×0.8	3	40.5	37.5	16.8	10.5	17.6	15	20.7	10	1.8	26	1.9
KD4-01-□			R1/8	8	43.5	39.5	18.8					2.5	29	4.5	
KD4-02-□			R1/4	11	46.5	40.5	19.8					14	38		
KD6-M5-□	6	8	M5×0.8	3	45.1	42.1	19	12.5	19.4	16	23	12	1.8	36	1.9
KD6-01-□			R1/8	8	48	44.1	21					4	38		
KD6-02-□			R1/4	11	51	45	22					14	46	10	
KD6-03-□			R3/8	12	52.8	46.5	23.5					17	59		
KD8-01-□	8	10	R1/8	8	52.8	48.8	24	14.5	20.2	17	24.8	14	6	48	20
KD8-02-□			R1/4	11	55.8	49.8	25					17	54		
KD8-03-□			R3/8	12	57.6	51.3	26.5					17	67		
KD10-01-□	10	12	R1/8	8	61.8	57.8	28.5	18.6	23.2	19.5	29.3	17	6	90	23
KD10-02-□			R1/4	11	64.8	58.8	29.5						8	93	
KD10-03-□			R3/8	12	65.8	59.4	30.2					22	8	101	35
KD10-04-□			R1/2	15	68.8	60.6	31.3						128		
KD12-02-□	12	14	R1/4	11	70.9	64.9	31.5	21.6	26.3	23	33.4	21	8	147	40
KD12-03-□			R3/8	12	71.9	65.5	32.2					9	153		
KD12-04-□			R1/2	15	74.9	66.7	33.3					22	169	50	

※ 1. "L1" and "L2" are reference values for height dimensions after tightening taper thread.

※ 2. □ in Model code / Replaced with "N"(NBR), or "F"(FKM) for Seal rubber material change

KD Run Tee without cover

NO COVER

RoHS compliant

OP
P.754

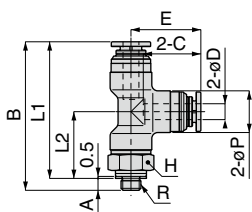

Metric thread

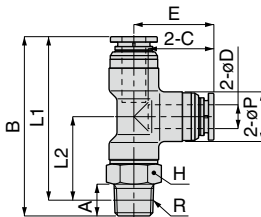

Taper pipe thread

Unit : mm

Model code	Tube O.D. φD	R	A	B	L1	L2	φP	Tube end C	E	Hex. H	Orifice dia.	Weight (g)	Effective area (mm ²)
KD4-M5-1-□	4	M5 × 0.8	3	37.4	34.4	16.8	10.5	14.5	17.6	10	1.8	23	1.9
KD4-01-1-□		R1/8	8	40.4	36.4	18.8				2.5	26	4.5	
KD4-02-1-□		R1/4	11	43.4	37.4	19.8				14	35		
KD6-M5-1-□	6	M5 × 0.8	3	42.2	39.2	19	12.5	16.5	20.1	12	1.8	33	1.9
KD6-01-1-□		R1/8	8	45.1	41.2	21				4	35	10	
KD6-02-1-□		R1/4	11	48.1	42.1	22				14	43		
KD6-03-1-□		R3/8	12	49.9	43.6	23.5				17	56		
KD8-01-1-□	8	R1/8	8	50.3	46.3	24	14.5	17.7	22.3	14	6	44	20
KD8-02-1-□		R1/4	11	53.3	47.3	25				17	50		
KD8-03-1-□		R3/8	12	55.1	48.8	26.5				6	63		
KD10-01-1-□	10	R1/8	8	58.6	54.6	28.5	18.5	20	26.1	17	8	80	23
KD10-02-1-□		R1/4	11	61.6	55.6	29.5				8	83		
KD10-03-1-□		R3/8	12	62.6	56.2	30.2				9	91		
KD10-04-1-□		R1/2	15	65.8	57.4	31.3				22	118		
KD12-02-1-□	12	R1/4	11	67.2	61.2	31.5	21.5	22.6	29.7	21	8	132	40
KD12-03-1-□		R3/8	12	68.2	61.8	32.2				9	138	50	
KD12-04-1-□		R1/2	15	71.2	63	33.3				22	154		

※ 1. "L1" and "L2" are reference values for height dimensions after tightening taper thread.

※ 2. □ in Model code / Replaced with "N"(NBR), or "F"(FKM) for Seal rubber material change

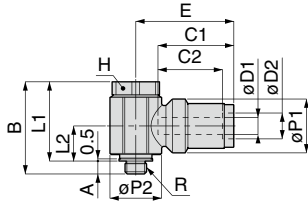

Metric thread

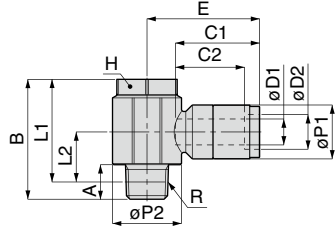

Taper pipe thread

Unit : mm

Model code	Tube O.D. øD1	Tube O.D. øD2	R	A	B	L1	L2	E	Tube end C1	Tube end C2	øP1	øP2	Hex. H	Weight (g)	Effective area (mm ²)
KH4-M5-□	4	6	M5×0.8	3	21.4	18.4	8.1	22.6	17.6	15	12.5	12	11	24.6	2
KH4-01-□			R1/8	8	27.8	23.8	11.6	24.8				16	14	38.4	4
KH6-M5-□	6	8	M5×0.8	3	21.4	18.4	8.1	24.1	19.5	16	12.5	12	11	25	2
KH6-01-□			R1/8	8	27.8	23.8	11.6	26.1				16	14	38.7	10
KH6-02-□			R1/4	11	34.3	28.3	14.9	27.6			14.5	19	17	58.6	12
KH6-03-□			R3/8	12	38.8	32.4	16.7	29.3				22.5	21	90.1	12
KH8-01-□			R1/8	8	27.8	23.8	11.6	26.9			20.2	17	14.5	16	14
KH8-02-□	R1/4	11	34.3	28.3	14.9	28.4	19	17	58.8	18					
KH8-03-□	R3/8	12	38.8	32.4	16.7	30.1	22.5	21	90.1	22					
KH10-02-□	10	12	R1/4	11	34.3	28.3	14.9	31.2	23.2	19.5	18.6	19	17	72.1	23
KH10-03-□			R3/8	12	38.8	32.4	16.7	33				22.5	21	111.3	28
KH10-04-□			R1/2	13.8	42.3	34.1	17.6	35.5			27.5	27	162.2	31	
KH12-03-□	12	14	R3/8	12	38.8	32.4	16.7	36.1	26.3	23	21.6	22.5	21	117.6	30
KH12-04-□			R1/2	13.8	42.3	34.1	17.6	38.8				27.5	27	168.9	41

※ 1. "L1" and "L2" are reference values for height dimensions after tightening taper thread.

※ 2. □ in Model code / Replaced with "N"(NBR), or "F"(FKM) for Seal rubber material change

KH
NO COVER

Single Banjo without cover

¥
P.709

OP.
P.754

RoHS compliant

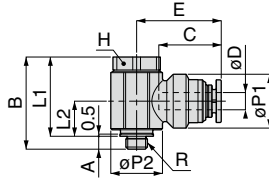

Metric thread

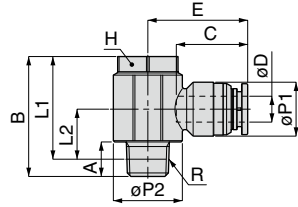

Taper pipe thread

Unit : mm

Model code	Tube O.D. øD	R	A	B	L1	L2	E	Tube end C	øP1	øP2	Hex. H	Weight (g)	Effective area (mm ²)
KH4-M5-1-□	4	M5 × 0.8	3	21.4	18.4	8.1	19.7	14.5	12.5	12	11	23	2
KH4-01-1-□		R1/8	8	27.8	23.8	11.6	21.7			16	14	36.7	4
KH6-M5-1-□	6	M5 × 0.8	3	21.4	18.4	8.1	21.2	16.6	12.5	12	11	23.3	2
KH6-01-1-□		R1/8	8	27.8	23.8	11.6	23.2			16	14	36.9	10
KH6-02-1-□		R1/4	11	34.3	28.3	14.9	24.7			19	17	56.9	12
KH6-03-1-□	8	R3/8	12	38.8	32.4	16.7	26.4	17.7	14.5	22.5	21	88.3	12
KH8-01-1-□		R1/8	8	27.8	23.8	11.6	24.4			16	14	39.1	14
KH8-02-1-□		R1/4	11	34.3	28.3	14.9	25.9			19	17	56.9	18
KH8-03-1-□	10	R3/8	12	38.8	32.4	16.7	27.6	20	18.5	19	17	67.2	23
KH10-02-1-□		R1/4	11	34.3	28.3	14.9	28			22.5	21	106.4	28
KH10-03-1-□		R3/8	12	38.8	32.4	16.7	29.8			27.5	27	157.3	31
KH10-04-1-□	12	R1/2	13.8	42.3	34.1	17.6	32.3	22.6	21.5	22.5	21	110.1	30
KH12-03-1-□		R3/8	12	38.8	32.4	16.7	32.4			27.5	27	161.4	41
KH12-04-1-□		R1/2	13.8	42.3	34.1	17.6	34.9						

※ 1. "L1" and "L2" are reference values for height dimensions after tightening taper thread.

※ 2. □ in Model code / Replaced with "N"(NBR), or "F"(FKM) for Seal rubber material change

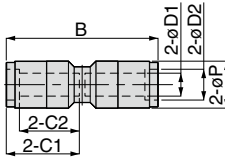

Unit : mm

Model code	Tube O.D. øD1	Tube O.D. øD2	øP	B	Tube end C1	Tube end C2	Orifice dia.	Effective area (mm ²)	Weight (g)
KU4-□	4	6	10.5	36.4	17.6	15	2.5	4.2	16
KU6-□	6	8	12.5	40.4	19.4	16	4	11	21
KU8-□	8	10	14.5	41.9	20.2	17	6	20	26
KU10-□	10	12	18.6	47.9	23.2	19.5	8	35	51
KU12-□	12	14	21.6	54.1	26.3	23	9	50	80

※ □ in Model code / Replaced with "N" (NBR), or "F" (FKM) for Seal rubber material change

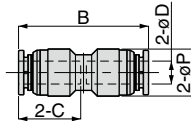

Unit : mm

Model code	Tube O.D. øD	øP	B	Tube end C	Orifice dia.	Effective area (mm ²)	Weight (g)
KU4-1-□	4	10.5	30.2	14.5	2.5	4.2	12
KU6-1-□	6	12.5	34.6	16.5	4	11	18
KU8-1-□	8	14.5	36.9	17.7	6	20	22
KU10-1-□	10	18.5	41.5	20	8	35	41
KU12-1-□	12	21.5	46.7	22.6	9	50	65

※ □ in Model code / Replaced with "N" (NBR), or "F" (FKM) for Seal rubber material change

KV Union Elbow

RoHS compliant

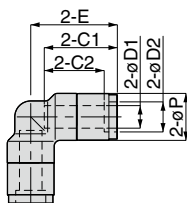

¥ P.710 OP P.754

Unit : mm

Model code	Tube O.D. øD1	Tube O.D. øD2	øP	Tube end C1	Tube end C2	E	Orifice dia.	Effective area (mm ²)	Weight (g)
KV4-□	4	6	10.5	17.6	15	20.7	2.5	3.5	17
KV6-□	6	8	12.5	19.4	16	23	4	9	23
KV8-□	8	10	14.5	20.2	17	24.8	6	16	29
KV10-□	10	12	18.6	23.2	19.5	29.3	8	30	58
KV12-□	12	14	21.6	26.3	23	33.4	9	39	94

※ . □ in Model code / Replaced with "N" (NBR), or "F" (FKM) for Seal rubber material change

FITTING

CONTROLLER

VALVE

TUBE

MAKE-TO-ORDER
PRODUCTS

230

KV Union Elbow without cover

NO COVER

RoHS compliant

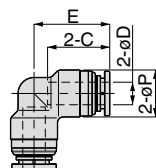

¥ P.710 OP P.754

Unit : mm

Model code	Tube O.D. øD	øP	Tube end C	E	Orifice dia.	Effective area (mm ²)	Weight (g)
KV4-1-□	4	10.5	14.5	17.6	2.5	3.5	13
KV6-1-□	6	12.5	16.5	20.2	4	9	19
KV8-1-□	8	14.5	17.7	22.3	6	16	25
KV10-1-□	10	18.5	20	26.1	8	30	48
KV12-1-□	12	21.5	22.6	29.7	9	39	79

※ . □ in Model code / Replaced with "N" (NBR), or "F" (FKM) for Seal rubber material change

Anti-siphon
& Press Series

Oil Temperature
Control

Minimal
Series

Stop Fitting
Series

Rotary
Series

Twist-Proof
Fitting

Block and
Connector

Coupling

Color
Cap



Union Tee

RoHS compliant

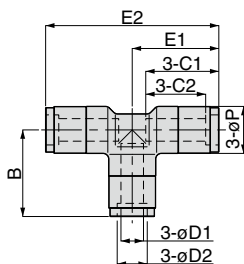

¥ P.710

OP. P.754

Unit : mm

Model code	Tube O.D. øD1	Tube O.D. øD2	øP	B	Tube end C1	Tube end C2	E1	E2	Orifice dia.	Effective area (mm ²)	Weight (g)
KE4-□	4	6	10.5	20.7	17.6	15	20.7	41.4	2.5	4.2	24
KE6-□	6	8	12.5	23.1	19.4	16	23.05	46.1	4	11	32
KE8-□	8	10	14.5	24.8	20.2	17	24.8	49.6	6	19	42
KE10-□	10	12	18.6	29.3	23.2	19.5	29.3	58.6	8	32	83
KE12-□	12	14	21.6	33.4	26.3	23	33.4	66.8	9	49	132

※ . □ in Model code / Replaced with "N" (NBR), or "F" (FKM) for Seal rubber material change



Union Tee without cover

RoHS compliant

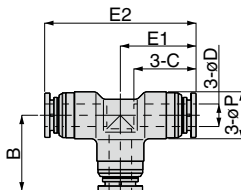

¥ P.710

OP. P.754

Unit : mm

Model code	Tube O.D. øD	øP	B	Tube end C	E1	E2	Orifice dia.	Effective area (mm ²)	Weight (g)
KE4-1-□	4	10.5	17.6	14.5	17.6	35.2	2.5	4.2	19
KE6-1-□	6	12.5	20.2	16.5	20.15	40.3	4	11	27
KE8-1-□	8	14.5	22.3	17.7	22.3	44.6	6	19	36
KE10-1-□	10	18.5	26.1	20	26.1	52.2	8	32	68
KE12-1-□	12	21.5	29.7	22.6	29.7	59.4	9	49	110

※ . □ in Model code / Replaced with "N" (NBR), or "F" (FKM) for Seal rubber material change

KM Bulkhead Union

RoHS compliant

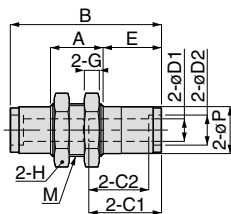

¥ P.710

OP P.754

Unit : mm

Model code	Tube O.D. φD1	Tube O.D. φD2	φP	M	B	Tube end C1	Tube end C2	A	E	Hex. H	G	Orifice dia.	Effective area (mm ²)	Weight (g)
KM4-□	4	6	10.5	M12×1	36.4	17.6	15	12	13.7	17	4	2.5	4.2	23
KM6-□	6	8	12.5	M14×1	40.4	19.4	16	14	15.6	17	4	4	11	33
KM8-□	8	10	14.5	M16×1	42.9	20.2	17	17	15.2	19	4	6	20	42
KM10-□	10	12	18.6	M20×1	49.9	23.2	19.5	22	16.3	24	5	8	35	83
KM12-□	12	14	21.7	M24×1	53.6	26.3	23	25.5	16.4	27	6	9	50	123

※ □ in Model code / Replaced with "N" (NBR), or "F" (FKM) for Seal rubber material change

FITTING

CONTROLLER

VALVE

TUBE

MAKE-TO-ORDER PRODUCTS

232

KM Bulkhead Union without cover

NO COVER

RoHS compliant

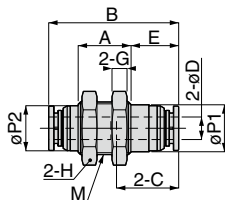

¥ P.710

OP P.754

Unit : mm

Model code	Tube O.D. φD	φP1	φP2	M	B	Tube end C	A	E	Hex. H	G	Orifice dia.	Effective area (mm ²)	Weight (g)
KM4-1-□	4	10.5	10	M12×1	30.2	14.5	12	10.6	17	4	2.5	4.2	19
KM6-1-□	6	12.5	12	M14×1	34.6	16.5	14	12.7	17	4	4	11	29
KM8-1-□	8	14.5	14	M16×1	37.9	17.7	17	12.7	19	4	6	20	38
KM10-1-□	10	18.5	18	M20×1	43.5	20	22	13.1	24	5	8	35	74
KM12-1-□	12	21.7	21	M24×1	46.2	22.6	25.5	12.7	27	6	9	50	108

※ □ in Model code / Replaced with "N" (NBR), or "F" (FKM) for Seal rubber material change

Anti-siphon & Press Series

Oil Temperature Control

Minimal Series

Stop Fitting Series

Rotary Series

Twist-Proof Fitting

Block and Connector

Coupling

Color Cap

KY Union Y

RoHS compliant

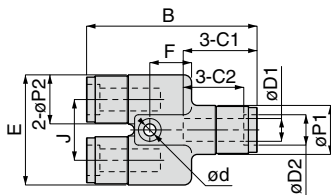

OP
P.754

Unit : mm

Model code	Tube O.D. øD1	Tube O.D. øD2	B	øP1	øP2	Tube end C1	Tube end C2	E	J	ød	F	Weight (g)	Effective area (mm ²)
KY4-□	4	6	42.2	10.9	11	17.6	15	25	14	3.2	10.8	37	3
KY6-□	6	8	44.9	12.9	12.9	19.5	16	29	16	3.2	11	48	7
KY8-□	8	10	49.4	14.9	14.9	20.2	17	33.5	18.5	3.2	14.4	69	16
KY10-□	10	12	57.5	18.9	19	23.2	19.5	42	23	4.2	18.7	135	29
KY12-□	12	14	63.9	21.9	22	26.3	23	48.5	26.5	4.2	20.4	204	36

※ 1. □ in Model code / Replaced with "N"(NBR), or "F"(FKM) for Seal rubber material change

KY Union Y without cover

RoHS compliant

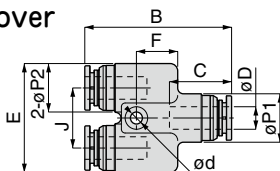

OP
P.754

Unit : mm

Model code	Tube O.D. øD	B	øP1	øP2	Tube end C	E	J	ød	F	Weight (g)	Effective area (mm ²)
KY4-1-□	4	36	10.9	11	14.5	25	14	3.2	10.8	32	3
KY6-1-□	6	39.1	12.9	12.9	16.6	29	16	3.2	11	43	7
KY8-1-□	8	44.4	14.9	14.9	17.7	33.5	18.5	3.2	14.4	64	16
KY10-1-□	10	51.1	18.9	19	20	42	23	4.2	18.7	120	29
KY12-1-□	12	56.5	21.9	22	22.6	48.5	26.5	4.2	20.4	181	36

※ 1. □ in Model code / Replaced with "N"(NBR), or "F"(FKM) for Seal rubber material change

CS Release-ring cover (Separately sold)

RoHS compliant

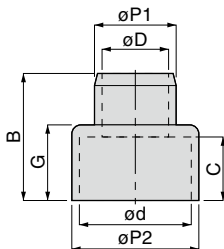

Unit : mm

Model code	Tube O.D. øD	B	øP1	øP2	Tube end C	G	ød	Weight (g)
CS 6	6	17	8	14	10	11.5	12	1
CS 8	8	19	10	16	11	12.5	14	1
CS 10	10	19.5	13	20	10.5	12	17	2
CS 12	12	23	15	23.5	11.5	13.5	20.5	3

※ . Reference size for Anti-splatter Tube "FB".

FB0425 : CS6, FB0640 : CS8, FB0860 : CS10, FB1075 : CS12, FB1290 : Not Available

※ . Release-ring cover is not available for tube dia. over ø 8 mm of Union Y "KY"



SAFETY Instructions

This safety instructions aim to prevent personal injury and damage to properties by requiring proper use of PISCO products.

Be certain to follow ISO 4414 and JIS B 8370

ISO 4414 : Pneumatic fluid power...Recommendations for the application of equipment to transmission and control systems.

JIS B 8370 : General rules and safety requirements for systems and their components.

This safety instructions is classified into "Danger", "Warning" and "Caution" depending on the degree of danger or damages caused by improper use of PISCO products.



Danger

Hazardous conditions. It can cause death or serious personal injury.



Warning

Hazardous conditions depending on usages. Improper use of PISCO products can cause death or serious personal injury.



Caution

Hazardous conditions depending on usages. Improper use of PISCO products can cause personal injury or damages to properties.



Warning

1. Selection of pneumatic products

- ① A user who is a pneumatic system designer or has sufficient experience and technical expertise should select PISCO products.
- ② Due to wide variety of operating conditions and applications for PISCO products, carry out the analysis and evaluation on PISCO products. The pneumatic system designer is solely responsible for assuring that the user's requirements are met and that the application presents no health or safety hazards. All designers are required to fully understand the specifications of PISCO products and constitute all systems based on the latest catalog or information, considering any malfunctions.

2. Handle the pneumatic equipment with enough knowledge and experience

- ① Improper use of compressed air is dangerous. Assembly, operation and maintenance of machines using pneumatic equipment should be conducted by a person with enough knowledge and experience.

3. Do not operate machine / equipment or remove pneumatic equipment until safety is confirmed.

- ① Make sure that preventive measures against falling work-pieces or sudden movements of machine are completed before inspection or maintenance of these machine.
- ② Make sure the above preventive measures are completed. A compressed air supply and the power supply to the machine must be off, and also the compressed air in the systems must be exhausted.
- ③ Restart the machines with care after ensuring to take all preventive measures against sudden movements.

Disclaimer

1. PISCO does not take any responsibility for any incidental or indirect loss, such as production line stop, interruption of business, loss of benefits, personal injury, etc., caused by any failure on use or application of PISCO products.
2. PISCO does not take any responsibility for any loss caused by natural disasters, fires not related to PISCO products, acts by third parties, and intentional or accidental damages of PISCO products due to incorrect usage.
3. PISCO does not take any responsibility for any loss caused by improper usage of PISCO products such as exceeding the specification limit or not following the usage the published instructions and catalog allow.
4. PISCO does not take any responsibility for any loss caused by remodeling of PISCO products, or by combinational use with non-PISCO products and other software systems.
5. The damages caused by the defect of Pisco products shall be covered but limited to the full amount of the PISCO products paid by the customer.



SAFETY INSTRUCTION MANUAL

PISCO products are designed and manufactured for use in general industrial machines. Be sure to read and follow the instructions below.

Danger

1. Do not use PISCO products for the following applications.
 - ① Equipment used for maintaining / handling human life and body.
 - ② Equipment used for moving / transporting human.
 - ③ Equipment specifically used for safety purposes.

Warning

1. Do not use PISCO products under the following conditions.
 - ① Beyond the specifications or conditions stated in the catalog, or the instructions.
 - ② Under the direct sunlight or outdoors.
 - ③ Excessive vibrations and impacts.
 - ④ Exposure / adhere to corrosive gas, inflammable gas, chemicals, seawater, water and vapor. *
* Some products can be used under the condition above(④), refer to the details of specification and condition of each product.
2. Do not disassemble or modify PISCO products, which affect the performance, function, and basic structure of the product.
3. Turn off the power supply, stop the air supply to PISCO products, and make sure there is no residual air pressure in the pipes before maintenance and inspection.
4. Do not touch the release-ring of push-in fitting when there is a working pressure. The lock may be released by the physical contact, and tube may fly out or slip out.
5. Frequent switchover of compressed air may generate heat, and there is a risk of causing burn injury.
6. Avoid any load on PISCO products, such as a tensile strength, twisting and bending. Otherwise, there is a risk of causing damage to the products.
7. As for applications where threads or tubes swing / rotate, use Rotary Joints, High Rotary Joints or Multi-Circuit Rotary Block only. The other PISCO products can be damaged in these applications.
8. Use only Die Temperature Control Fitting Series, Tube Fitting Stainless SUS316 Series, Tube Fitting Stainless SUS316 Compression Fitting Series or Tube Fitting Brass Series under the condition of over 60°C (140° F) water or thermal oil. Other PISCO products can be damaged by heat and hydrolysis under the condition above.
9. As for the condition required to dissipate static electricity or provide an antistatic performance, use EG series fitting and antistatic products only, and do not use other PISCO products. There is a risk that static electricity can cause system defects or failures.
10. Use only Fittings with a characteristic of spatter-proof such as Anti-spatter or Brass series in a place where flame and weld spatter is produced. There is a risk of causing fire by sparks.
11. Turn off the power supply to PISCO products, and make sure there is no residual air pressure in the pipes and equipment before maintenance. Follow the instructions below in order to ensure safety.
 - ① Make sure the safety of all systems related to PISCO products before maintenance.
 - ② Restart of operation after maintenance shall be proceeded with care after ensuring safety of the system by preventive measures against unexpected movements of machines and devices where pneumatic equipment is used.
 - ③ Keep enough space for maintenance when designing a circuit.
12. Take safety measures such as providing a protection cover if there is a risk of causing damages or fires on machine / facilities by a fluid leakage.

⚠ Caution

1. Remove dusts or drain before piping. They may get into the peripheral machine / facilities and cause malfunction.
2. When inserting an ultra-soft tube into push-in fitting, make sure to place an Insert Ring into the tube edge. There is a risk of causing the escape of tube and a fluid leakage without using an Insert Ring.
3. The product incorporating NBR as seal rubber material has a risk of malfunction caused by ozone crack. Ozone exists in high concentrations in static elimination air, clean-room, and near the high-voltage motors, etc. As a countermeasure, material change from NBR to HNBR or FKM is necessary. Consult with PISCO for more information.
4. Special option "Oil-free" products may cause a very small amount of a fluid leakage. When a fluid medium is liquid or the products are required to be used in harsh environments, contact us for further information.
5. In case of using non-PISCO brand tubes, make sure the tolerance of the outer tube diameter is within the limits of Table 1.

● Table 1. Tube O.D. Tolerance

mm size	Nylon tube	Polyurethane tube	inch size	Nylon tube	Polyurethane tube
ø1.8mm	—	± 0.05mm	ø1/8	± 0.1mm	± 0.15mm
ø3mm	—	± 0.15mm	ø5/32	± 0.1mm	± 0.15mm
ø4mm	± 0.1mm	± 0.15mm	ø3/16	± 0.1mm	± 0.15mm
ø6mm	± 0.1mm	± 0.15mm	ø1/4	± 0.1mm	± 0.15mm
ø8mm	± 0.1mm	± 0.15mm	ø5/16	± 0.1mm	± 0.15mm
ø10mm	± 0.1mm	± 0.15mm	ø3/8	± 0.1mm	± 0.15mm
ø12mm	± 0.1mm	± 0.15mm	ø1/2	± 0.1mm	± 0.15mm
ø16mm	± 0.1mm	± 0.15mm	ø5/8	± 0.1mm	± 0.15mm

6. Instructions for Tube Insertion

- ① Make sure that the cut end surface of the tube is at right angle without a scratch on the surface and deformations.
- ② When inserting a tube, the tube needs to be inserted fully into the push-in fitting until the tubing edge touches the tube end of the fitting as shown in the figure below. Otherwise, there is a risk of leakage.

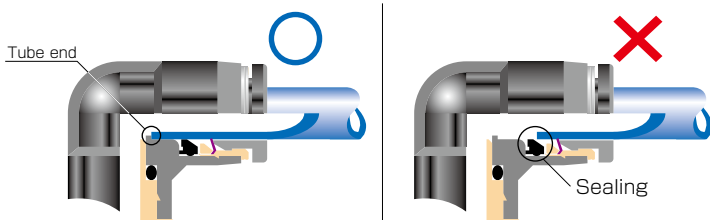

Tube is not fully inserted up to tube end.

- ③ After inserting the tube, make sure it is inserted properly and not to be disconnected by pulling it moderately.
- ※ When inserting tubes, Lock-claws may be hardly visible in the hole, observed from the front face of the release-ring. But it does not mean the tube will surely escape. Major causes of the tube escape are the followings;
- ① Shear drop of the lock-claws edge
 - ② The problem of tube diameter (usually small)
- Therefore, follow the above instructions from ① to ③, even lock-claws is hardly visible.

7. Instructions for Tube Disconnection

- ① Make sure there is no air pressure inside of the tube, before disconnecting it.
- ② Push the release-ring of the push-in fitting evenly and deeply enough to pull out the tube toward oneself. By insufficient pushing of the release-ring, the tube may not be pulled out or damaged by scratch, and tube shavings may remain inside of the fitting, which may cause the leakage later.

8. Instructions for Installing a fitting

- ① When installing a fitting, use proper tools to tighten a hexagonal-column or an inner hexagonal socket. When inserting a hex key into the inner hexagonal socket of the fitting, be careful so that the tool does not touch lock-claws. The deformation of lock-claws may result in a poor performance of systems or an escape of the tube.
- ② Refer to Table 2 which shows the recommended tightening torque. Do not exceed these limits to tighten a thread. Excessive tightening may break the thread part or deform the gasket and cause a fluid leakage. Tightening thread with tightening torque lower than these limits may cause a loosened thread or a fluid leakage.
- ③ Adjust the tube direction while tightening thread within these limits, since some PISCO products are not rotatable after the installation.

● Table 2: Recommended tightening torque / Sealock color / Gasket materials

Thread type	Thread size	Tightening torque	Sealock color	Gasket materials
Metric thread	M3 × 0.5	0.7N·m	—	SUS304 NBR
	M5 × 0.8	1.0 ~ 1.5N·m		
	M6 × 1	2 ~ 2.7N·m		
	M3 × 0.5	0.5 ~ 0.6N·m		POM
	M5 × 0.8	1 ~ 1.5N·m		
	M6 × 0.75	0.8 ~ 1N·m		
Taper pipe thread	M8 × 0.75	1 ~ 2N·m	White	—
	R1/8	7 ~ 9N·m		
	R1/4	12 ~ 14N·m		
	R3/8	22 ~ 24N·m		
Unified thread	R1/2	28 ~ 30N·m	—	SUS304, NBR
	No.10-32UNF	1.0 ~ 1.5N·m		
National pipe thread taper	1/16-27NPT	7 ~ 9N·m	White	—
	1/8-27NPT	7 ~ 9N·m		
	1/4-18NPT	12 ~ 14N·m		
	3/8-18NPT	22 ~ 24N·m		
	1/2-14NPT	28 ~ 30N·m		

※ These values may differ for some products. Refer to each specification as well.

9. Instructions for removing a fitting

- ① When removing a fitting, use proper tools to loosen a hexagonal-column or an inner hex bolt.
- ② Remove the sealant stuck on the mating equipment. The remained sealant may get into the peripheral equipment and cause malfunctions.

10. Arrange piping avoiding any load on fittings and tubes such as twist, tensile, moment load, shaking and physical impact. These may cause damages to fittings, tube deformations, bursting and the escape of tubes.

Common Safety Instructions for Fittings

Before selecting or using PISCO products, read the following instructions. Read the detailed instructions for individual series as well as the instructions below.

Warning

1. Do not use fittings with fluid medium other than air or water. (Water can be used with some series.) Contact us for using other kind of fluid medium except air and water.
2. Do not use fittings except Anti-spatter, Brass and Brass Compression Fitting series in a place where the flame and weld spatter is produced. There is a risk of causing fire by sparks.
3. As for applications where threads or tubes swing / rotate, use Rotary Joints, High Rotary Joints or Multi-Circuit Rotary Block only. The other PISCO products can be damaged in these applications.
4. Use only Die Temperature Control Fitting Series, Tube Fitting Stainless SUS316 Series, Tube Fitting Stainless SUS316 Compression Fitting Series or Tube Fitting Brass Series under the condition of over 60°C (140° F) water or thermal oil. Other PISCO products can be damaged by heat and hydrolysis under the condition above.
5. As for the condition required to dissipate static electricity or provide an antistatic performance, use EG Series fitting and antistatic products only, and do not use other PISCO products. There is a risk that static electricity can cause system defects or failures.
6. Avoid any load on PISCO products, such as a tensile strength, twisting and bending. Otherwise, there is a risk of causing damage to the products.

⚠ Caution

1. In case of using non-PISCO brand tubes, make sure the tolerance of the outer tube diameter is within the following limits of Table 1.

● Table 1. Tube O.D. Tolerance

mm size	Nylon tube	Urethane tube	inch size	Nylon tube	Urethane tube
ø1.8mm	—	± 0.05mm	ø1/8	± 0.1mm	± 0.15mm
ø3mm	—	± 0.15mm	ø5/32	± 0.1mm	± 0.15mm
ø4mm	± 0.1mm	± 0.15mm	ø3/16	± 0.1mm	± 0.15mm
ø6mm	± 0.1mm	± 0.15mm	ø1/4	± 0.1mm	± 0.15mm
ø8mm	± 0.1mm	± 0.15mm	ø5/16	± 0.1mm	± 0.15mm
ø10mm	± 0.1mm	± 0.15mm	ø3/8	± 0.1mm	± 0.15mm
ø12mm	± 0.1mm	± 0.15mm	ø1/2	± 0.1mm	± 0.15mm
ø16mm	± 0.1mm	± 0.15mm	ø5/8	± 0.1mm	± 0.15mm

2. Instructions for Tube Insertion

- ① Make sure that the cut end surface of the tube is at right angle without a scratch on the tube surface and deformations.
- ② When inserting a tube, the tube needs to be inserted fully into the push-in fitting until the tubing edge touches the tube end of the fitting as shown in the figure below. Otherwise, there is a risk of leakage.

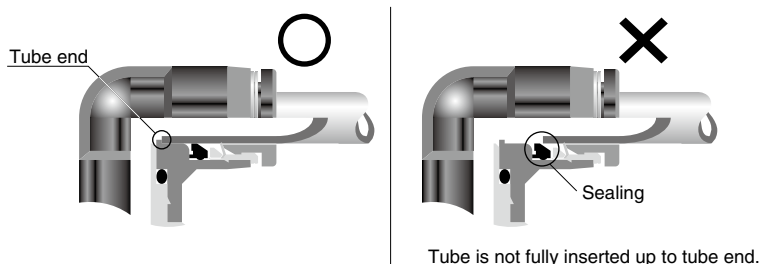

- ③ After inserting the tube, make sure it is inserted properly and not to be disconnected by pulling it moderately.

3. Instructions for Tube Disconnection

- ① Make sure there is no air pressure inside of the tube, before disconnecting it.
- ② Push the release-ring of the push-in fitting evenly and deeply enough to pull out the tube toward oneself. By insufficient pushing of the release-ring, the tube may not be pulled out or damaged by scratch, and tube shavings may remain inside of the fitting, which may cause the leakage later.

4. Instructions for Installing a fitting

- ① When installing a fitting, use proper tools to tighten a hexagonal-column or an inner hexagonal socket. When inserting a hex key into the inner hexagonal socket of the fitting, be careful so that the tool does not touch lock-claws. The deformation of lock-claws may result in a poor performance of systems or an escape of the tube.
- ② Refer to Table 2 which shows the recommended tightening torque. Do not exceed these limits to tighten a thread. Excessive tightening may break the thread part or deform the gasket and cause a fluid leakage. Tightening thread with tightening torque lower than these limits may cause a loosened thread or a fluid leakage.
- ③ Adjust the tube direction while tightening thread within these limits, since some PISCO products are not rotatable the installation.

● Table 2: Recommended tightening torque / Sealock color / Gasket materials

Thread type	Thread size	Tightening torque	Sealock color	Gasket materials
Metric thread	M3 × 0.5	0.7N·m	—	SUS304 NBR
	M5 × 0.8	1.0 ~ 1.5N·m		
	M6 × 1	2 ~ 2.7N·m		
	M3 × 0.5	0.5 ~ 0.6N·m		POM
	M5 × 0.8	1 ~ 1.5N·m		
	M6 × 0.75	0.8 ~ 1N·m		
	M8 × 0.75	1 ~ 2N·m		
Taper pipe thread	R1/8	7 ~ 9N·m	White	—
	R1/4	12 ~ 14N·m		
	R3/8	22 ~ 24N·m		
	R1/2	28 ~ 30N·m		
Unified thread	No.10-32UNF	1.0 ~ 1.5N·m	—	SUS304, NBR
National pipe thread taper	1/16-28NPT	7 ~ 9N·m	White	—
	1/8-27NPT	7 ~ 9N·m		
	1/4-18NPT	12 ~ 14N·m		
	3/8-18NPT	22 ~ 24N·m		
	1/2-14NPT	28 ~ 30N·m		

※. These values may differ for some products. Refer to each specification as well

5. Instructions for removing a fitting

- ① When removing a fitting, use proper tools to loosen a hexagonal-column or an inner hexagonal socket.
- ② Remove the sealant stuck on the mating equipment. The remained sealant may get into the peripheral equipment and cause malfunctions.

6. Arrange piping avoiding any load on fittings and tubes such as twist, tensile, moment load, shaking and physical impact. These may cause damages to fittings, tube deformations, bursting and the escape of tubes.