

DLP 3D PRINTER

CLASSIC

WANHAO DUPLICATOR 7

DESK TOP 3D PRINTER

NEW PRODUCT

2017



**PRINTING
MORE PRECISE,
BETTER VALUE
THE BEST ACCURACY**

USER MANUAL



WWW.WANHAO3DPRINTER.COM



SUPPORT@WANHAO3DPRINTER.COM

Important

Getting the most out of your 3D Printer:

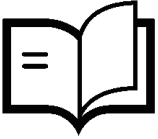

Read the manual carefully

It will help you get set up with ease



Visit www.wanhao3dprinter.com

We've got additional support videos and guides



Google Forum

Join Wanhao Technical Forum for online support

<https://groups.google.com/forum/#!forum/wanhao-printer-3d>



Email support@wanhao3dprinter.com

We're always happy to help

Warranty Note

If you experience any issues with this product, or it's performance is not what you had expected, please contact us at WANHAO before returning the item to the store.

It is likely that we can resolve any problems for you via phone or email.

We can be reached through your local distributor. Or on

Phone: +86-571-23290996(Mon-Sat; 8:30am-5:00pm)

Email: support@wanhao3dprinter.com

Web: www.wanhao3dprinter.com



3D Printer

Warranty Details

The product is guaranteed to be free from defects in workmanship and mother board for a period of 12 months from the date of purchase. The LCD display is consumable parts with Minimal working hours 1200 hours. You may need to purchase and replace it after 1200 hours. Printing with materials other than WANHAO resin which are different from those recommended on the website www.wanhao3dprinter.com may cause result in damage the printer or bad printing quality. Defects that occur within this warranty period, under normal use and care, will be repaired, replaced or refunded at our discretion. The benefits conferred by this warranty are in addition to all rights and remedies in respect of the product that the consumer has under the China laws. In case you purchase from WANHAO distributor, your warranty shall be covered by distributor's Warranty and honored by WANHAO distributor too. Our goods come with guarantees that cannot be excluded under the Chinese Consumer Law. You are entitled to a replacement or refund for a major failure and for compensation for any other reasonably foreseeable loss or damage. You are also entitled to have the goods repaired or replaced if the goods fail to be of acceptable quality and the failure does not amount to a major failure.

AFTER SALES SUPPORT

 86-571-23290996

 support@wanhao3dprinter.com

Model : Duplicator 7





Safety Instructions

Before you get started, please read these important safety instructions.

CAUTION: The WANHAO 3D Printer includes moving parts that can cause injury. Never reach inside of the WANHAO 3D Printer while it is in operation, and allow time for the printer to cool down after operation.

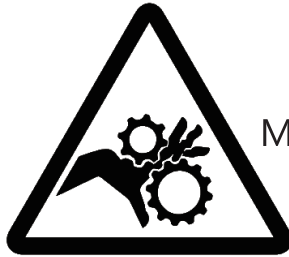

MOVING PARTS



Do not leave the WANHAO 3D Printer unattended during operation



Always wear the glove while handling resin or printing object.



Always take care when using the Scraper. Never direct the Scraper towards your fingers.

- The printer must not be exposed to water or rain, or damage will occur.
- The printer is designed to be used with ambient temperature ranging 15°C - 30°C, and humidity ranging 20% - 50%. Operating outside these limits may result in low quality models.
- In case of emergency, turn off the 3D printer at the power outlet.
- It is recommended that you use eye protection when cleaning/sanding printed models to avoid small particles contacting eyes.

AFTER SALES SUPPORT



86-571-23290996



support@wanhao3dprinter.com

Model : Duplicator 7



WANHAO

Contents

Warranty Details	2
A. Safety Instructions	3
B. Congratulations	5
The principle behind your printer	5
Safety Information	5
C. Electrical power	6
Disposal instructions	6
D. Useful advice	7
The box contains	7
Recommended items	7
Minimum computer requirements	7
E. Installation & assembly instructions	8
F. Prepare the Duplicator 7 for printing	15
G. Cleaning the machine and your printed objects	18
H. Detailed Creation workshop software instructions	19
System Compatibility	19
Main screen	19
1. Loading a Model	20
2. Scene View	21
3. Object Info	21
4. Move View	22
5. Mirroring Objects	22
6. Scaling Objects	22
7. Rotating Objects	23
8. View Options	23
9. Working with Model Support tools	24
10. Saving a Scene	24
11. Slice View	25
12. Control	26
13. Configure	27
13.1 Configure Machine	27
13.2 Configure Slicing Profile	29
14. Slicing a Model	31
15. Connecting Software to Duplicator 7	31
Repair and Refurbished Goods or Parts Notice	33

AFTER SALES SUPPORT



86-571-23290996



support@wanhao3dprinter.com

Model : Duplicator 7



Congratulations

You have just purchased a new type of 3D printer using Direct UV-light Printing (DUP) technology. This is a newly applied-for method of LCD image creation allow controlled UV light get through the LCD screen which hardens liquid with the light from an UV light source. This revolutionary system is a new way of printing that uses normal UV light as the energy providing source to initiate the free radical polymerisation necessary to change the liquid imagepac resin into your hardened object.

The principle behind your printer

There are two surprising advantages of this new DUP technology:

- i) We can use high resolution low cost LCD screens that are widely available as monitors, tablets, mobile phone and televisions providing phenomenal value for money, which we pass directly onto you.
- ii) The energy used by Duplicator 7 printers is again an order of magnitude lower than used in comparable systems. This is good for your energy bills and the ecology, but there is a huge performance advantage in that there is no unnecessary energy created. All of the available photons strike photoinitiators and hand over their energy. In comparable Digital Light Projector and laser systems there is a lot of excess energy which can lead to over-cure.

Safety Information

Read the instructions carefully. Keep this document for future reference. Follow all warnings and instructions marked on the product.

Observe the following guidelines when connecting and disconnecting power cord to the printer.

- Insert the Power cable cord into the socket at back of printer.
- Turn off the printer before Unplug the power cord.
- The printer cooling fan is suppose to run when you tun on the printer.
- Operate on a table or flat, stable surface, ensuring that the machine cannot fall and is level.
- Do not operate outdoors.
- Do not allow resin or any liquids to get inside the chassis, wipe up any liquid spills immediately.
- Store the printer in its original packaging when not in use.
- Plug off the cable cord when not used for a long period of time.



Electrical power

This 3D printer is connected to the electrical network with an INPUT of 110 or 240 VAC, 50/60 Hz, and has an operational voltage of 12 V.

- Do not allow anything to rest on the power cord. Do not locate this product where people will walk on the cord.
- If an extension cord is used with this product, make sure that the total ampere rating of the equipment plugged into the extension cord does not exceed the extension cord ampere rating. Also, make sure that the total rating of all products plugged into the wall outlet does not exceed the fuse rating.
- Do not overload a power outlet, strip or receptacle by plugging in too many devices.
- Use the product only with the supplied power supply cord set. If you need to replace the power cord set, make sure that the new power cord meets the following requirements: detachable type, UL listed/CSA certified, VDE approved or its equivalent, 4.5 meters (15 feet) maximum
- In case of malfunction disconnect the printer immediately from network.
- Do not attempt to fix this product by yourself, as opening or removing covers may expose you to dangerous voltage points or other risks. Refer all reparation to qualified service personnel. For contact the technical service please send an email to your national supplier or www.wanhao3dprinter.com

Unplug this product from the wall outlet and refer servicing to qualified service personnel when:

- The power cord or plug is damaged, cut or frayed.
- Liquid was spilled into the product.
- The product was exposed to rain or water.
- The product has been dropped or the case has been damaged.
- The product exhibits a distinct change in performance, indicating a malfunction.
- The product does not operate normally after following the operating instructions.
- Keep the printer out of the reach of small children.

Disposal instructions

Do not throw this electronic device into the waste when discarding. To minimize pollution and ensure utmost protection of the global environment, please recycle or return to WANHAO for recycling.



AFTER SALES SUPPORT

 86-571-23290996

 support@wanhao3dprinter.com

Model : Duplicator 7



Useful advice

Have supervision when used by a minor.

The resin is an irritant to skin and eyes. Always wear gloves when coming into contact with the liquid resin.

The printer should be operated on a stable and level surface, preferably away from direct ambient light and with sufficient space to be able to open doors

The box contains

- Wanhao Duplicator 7 LCD printer with black hood and platform
- Power cable cord
- VAT with film
- HDMI cable to connect the 3D printer to the secondary video output of your computer (2).
- USB cable to connect your computer to the printer.
- 1 replacement films for the VAT
- plastic spatula
- 250ml UV resin

Recommended items

- Gloves
- Paper towels
- industrial alcohol
- Soft brush or sponge to clean the object
- Plastic container to rinse the resin

Minimum computer requirements

- Dual Core processor or above.
- Windows or Linux OS
- Software NOT compatible with MAC
- 4 GB RAM memory or above.
- Double video output graphics card (one for your monitor, one for the Printer HDMI, with 500MB memory or above. A laptop with dual video output(HDMI) is also possible.





Installation & assembly instructions

- 1.0 To set the printer display
- 1.1 Right click the mouse and click the display setting.
- 1.2 Turn on the printer, connect the HDMI cable and USB cable to the computer.
The computer would install the Arduino Mega 2560 driver automatically.



- 1.3 Right Click the mouse and click the display setting



- 1.4 Click the display No.2, then the No.2 display would be highlighted in green color.
- 1.5 If your display is not lateral. Change it to lateral by click direction and choose lateral.
- 1.6 Commit the change.

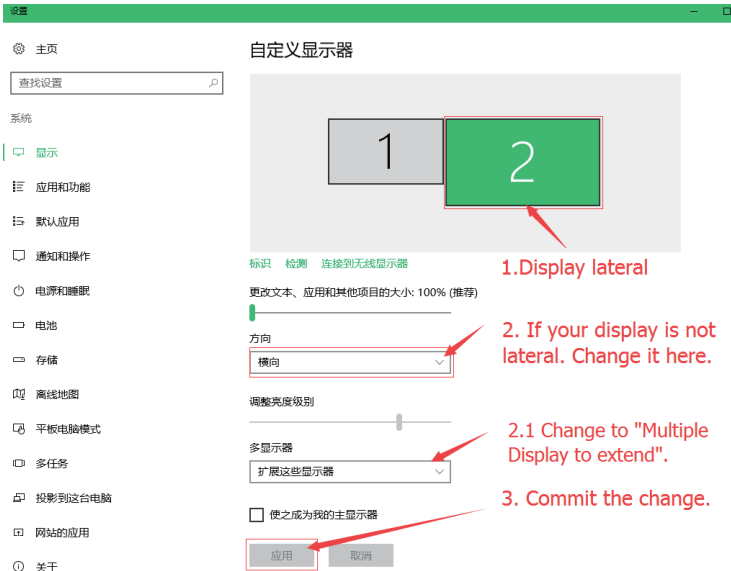

2.0 To set the software: Creation Workshop.

2.1 Decompress the Creation workshop. Click the Creation Workshop logo to run software.



2.2 Click the Configure

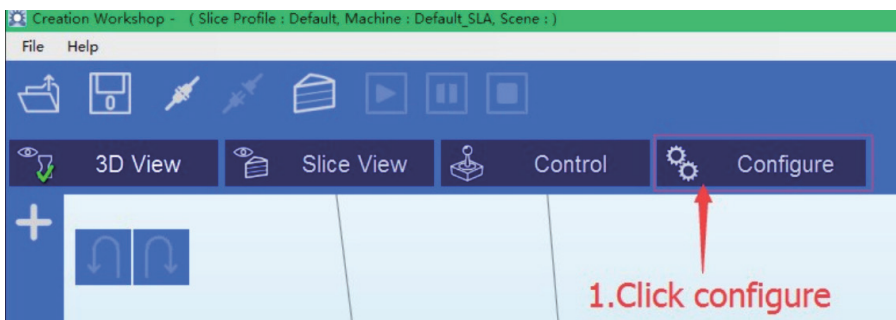

2.3 Configure the machine

Click configure

Choose the current connection port. (could be Com5, Com6... depending on your computer)

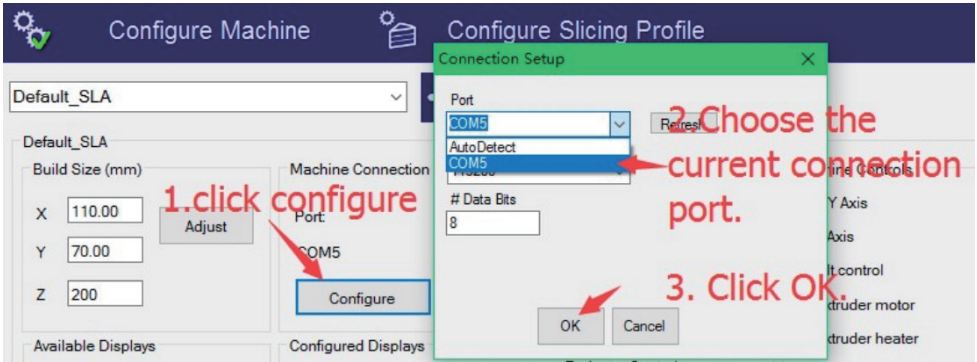

2.4 Choose screen size: 1560*1440 from Available Display Click + to add the secondary screen Apply the change.

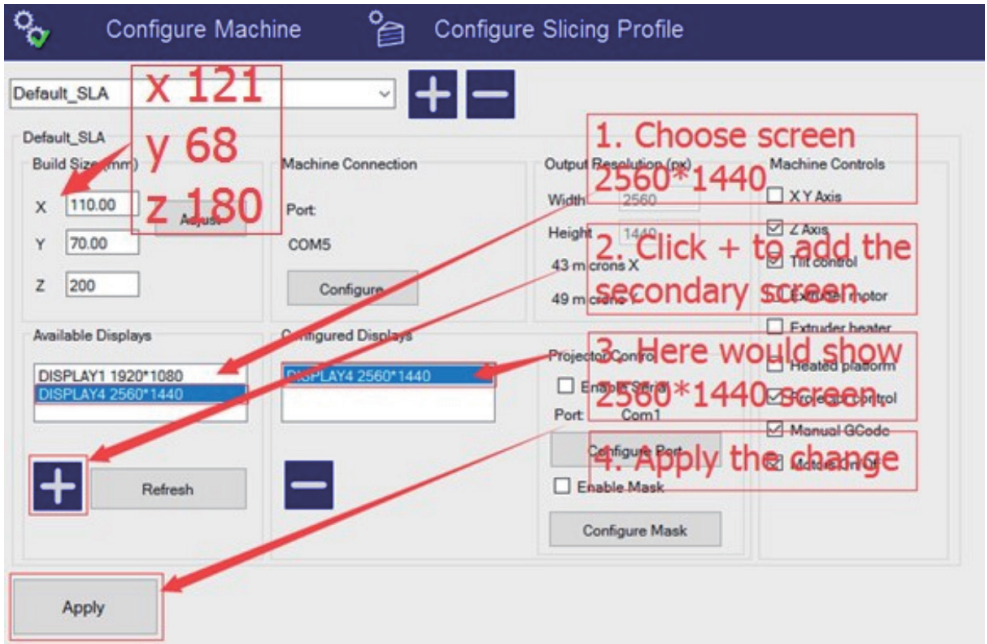

2.5 Click the connection button to link the printer and computer.



Then the disconnection button would be highlighted.



3.0 Testing the Z axis movement and raise the Z axis by 50mm minimal. So we can check if the first layer printing work or not .

Click the Control, Then click the "+Z" to raise the building plate by 50mm/click.

P.S: Z button= Z axis home.

10= raise Z by 10mm/click

1= raise Z by 1mm/click

-z= lower Z by 50mm/click

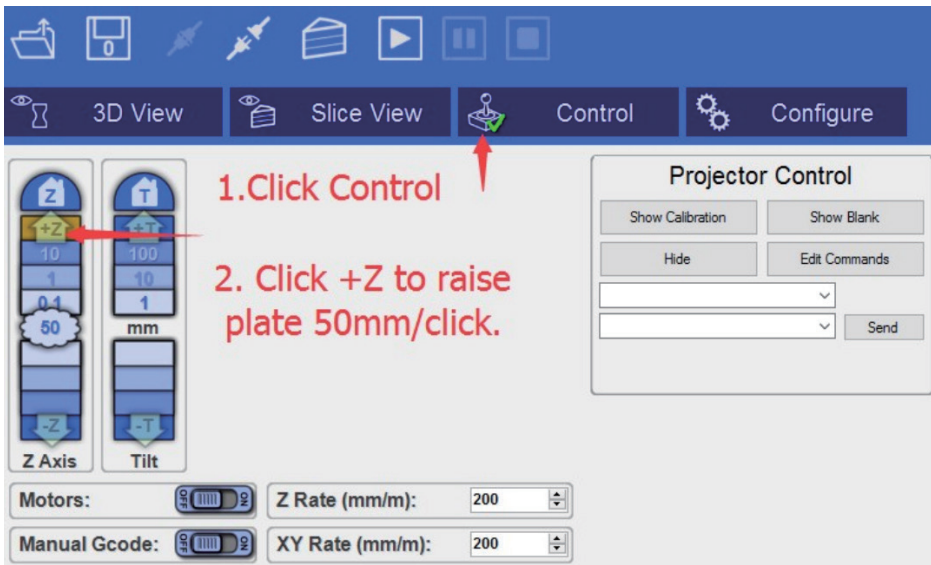

4.0 Open the printing file and Check the first layer work or not.

4.1 Click the open file button .



4.2 Choose and open any 3D model in STL or OBJ

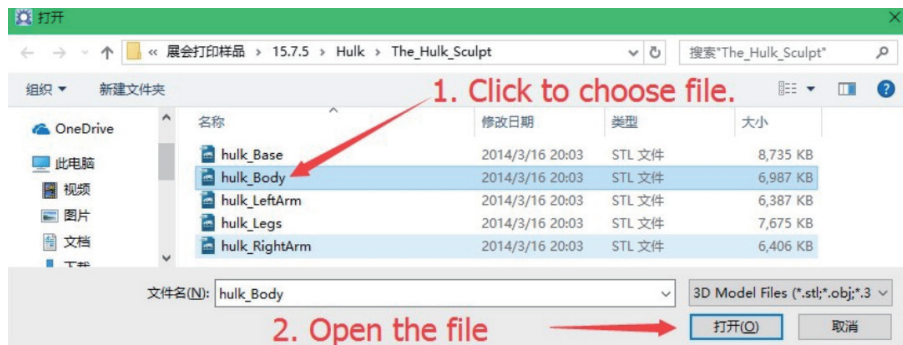

4.3 To do 3D view and adjust the object. Then click "+" to add RAFT and SUPPORT.

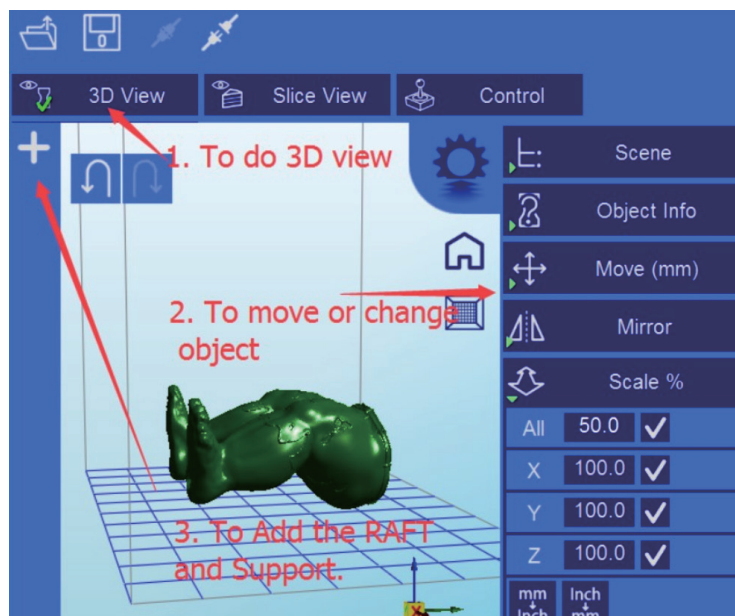

AFTER SALES SUPPORT

4.4 To click the +_ to add the RAFT, so the first layer would be the RAFT.

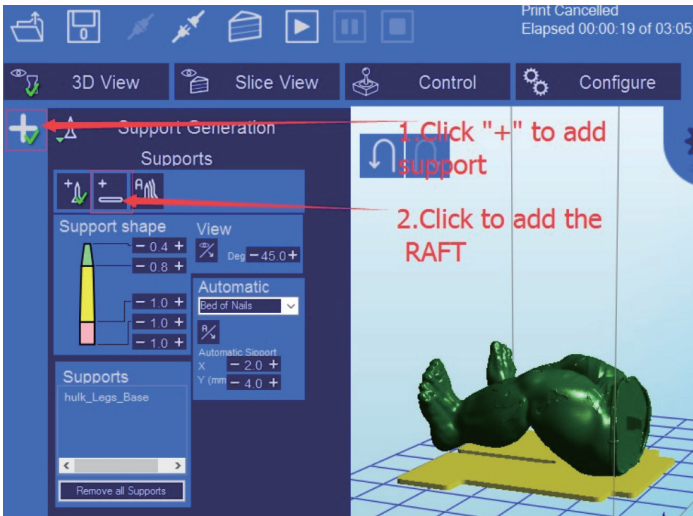

4.5 Right click the screen and move the print object, so you would see the image of Raft like below.

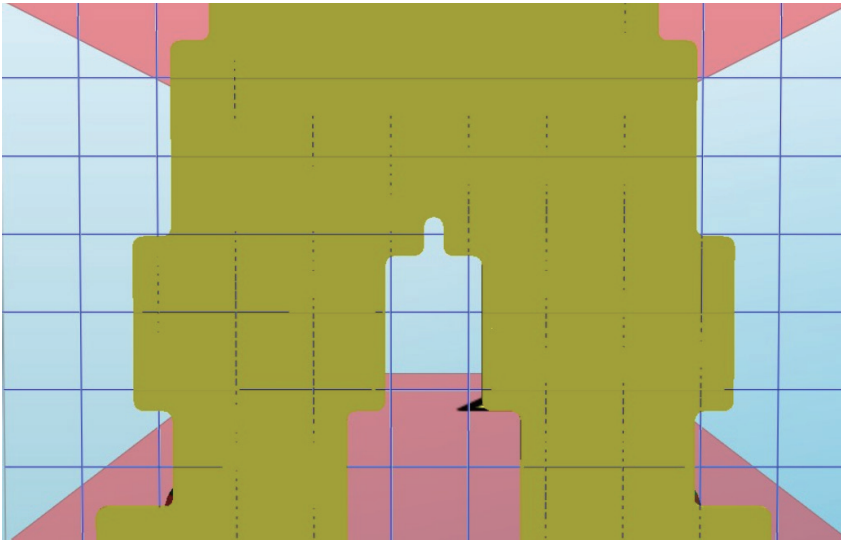



4.6 Click the slicing and confirm slice. The print object would be sliced.

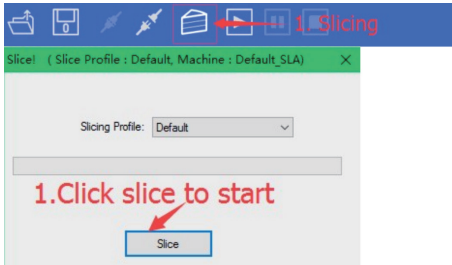

4.7 Click Print button. So you would see the image to be projected on the LCD screen which is exactly the same like your computer screen first layer.

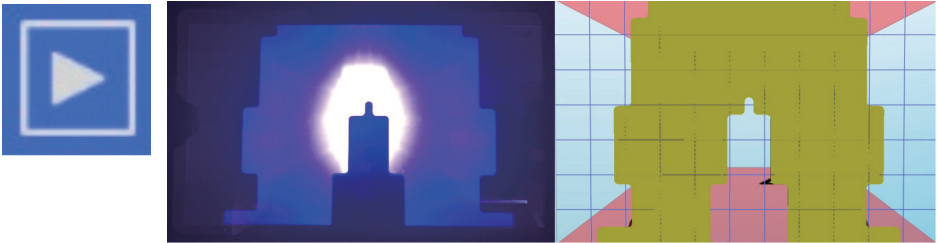

Congratulations! You have successfully installed the machine. Now you can start your first print.

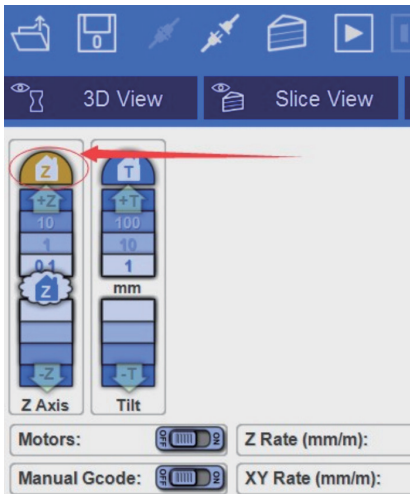

5.0 First Print

5.1 To click home Z axis. So building plate would start from home position.

5.2 Repeat the 7.0 to print the first object.

AFTER SALES SUPPORT

86-571-2329096

support@wanhao3dprinter.com

Model : Duplicator 7

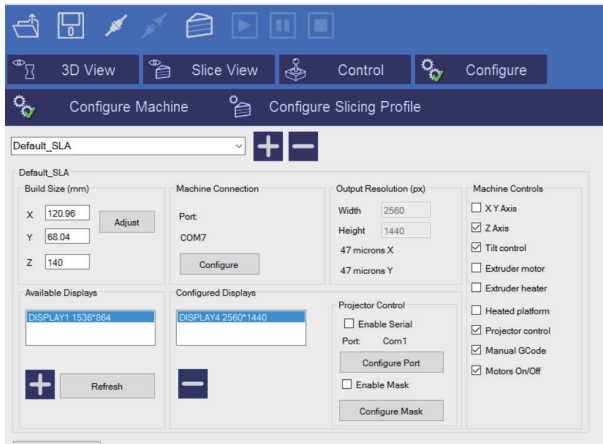

Prepare the Duplicator 7 for printing

Now you have your printer installed and configured. Please read these software instructions to understand the different settings before starting.

Let's start by printing the first object using the stock WANHAO resin and do the printout at the lowest resolution so that the test doesn't take too long. You will find some test objects (STL file) in the folders supplied with the software.

1. Switch on your computer and the switch on the Duplicator 7. Open the software and load an object (STL, OBJ or AMF).
2. With the object loaded and located in the build area check the settings of the printing profile.
3. Set the values in the "setting" fields to:
 - layer thickness = 0.100 mm,
 - exposure time = between 6.000-12.000
 - for other resins and resolutions check the exposure times stated
 - exposure time for bottom layers = between 100.000 and 120.000 ms
 - number of such bottom layers = between 3 and 5

These settings can be adjusted depending upon the complexity of the desired object. Finally click "Apply Changes" to save if you had to change any values, if you don't click this your data will not be re-set.



The screen should look as follow:

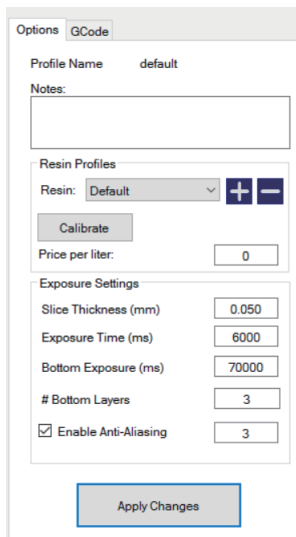
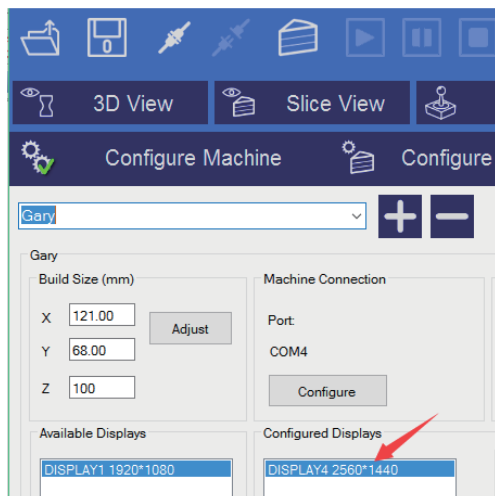

4. Now click “3D View” and check that the object is correctly placed inside the printing area. Press the  slice button to start the slicing operation. A confirmation window will show:

You can check again that the correct profile is being used and if not, you can select the correct one. Always click on the “Slice” button if you adjust the layout in any way.

5. Now check the “Slice View” screen to check that the first layer of every object is in contact with the build base. If it is above the build platform it will not adhere. If you click on the view box located in the bottom left corner you can scroll forward through the slicing views using the slider bar and check that the object is always inside the build area. Make sure that objects are 2 squares inside the edge of the build area shown.



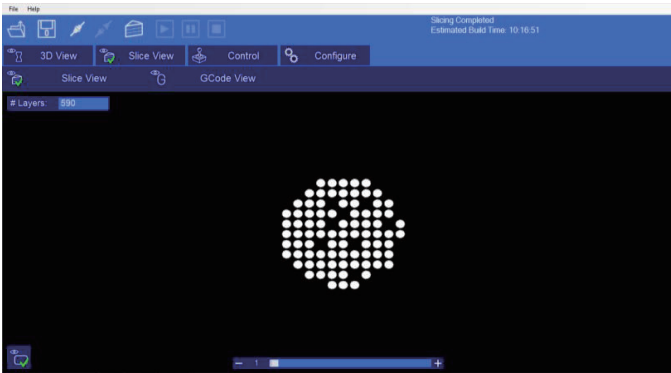

6. Place the vat on top of the LCD screen and tighten the retaining Z brackets down to secure it. If you tighten it too much the LCD screen will go white at the edges. The tray should not be able to be lifted up.
7. Slide the platform onto the platform arm and firmly tighten the central knob. Loosen the 4 screws at the sides so there is free movement of the platform up and down (IMPORTANT if these knobs are not completely loose you could crush the bottom screen when lowering it with the home function).
8. Press the "Home" button to lower the platform onto the screen. The platform will move down to be resting on the screen (level 0 in Z axis.) and stop. Remove the hood. With one hand press down on the middle of the glass platform and with the other tighten a side bolt, then repeat with the other bolt. Now the 3 knobs should be tight. You can check that the platform is making contact with the screen by pressing lightly when it is on and it will appear white in the corners. You can check the screen is working by pressing the "show calibration" button located in the "Control" tab and a grid will appear. It is now locked in the home position.
9. Press the +10 steps button in "Control" and the platform will rise enough to pour resin in under it. Remove the hood and fill the vat with resin. Prints don't consume a lot of resin, a quarter full vat will be enough for a medium sized print. Note, once started, the print can't be paused and refilled so it's safer to over-fill and re-use the resin. Place the hood back on the printer and move the platform back to home by hitting the -1 step button 10 times, leave a few seconds between click to enable the resin to move out. It is essential it is grounded before starting printing, if you miss-count it is safer to press an additional step, the platform will not move further when correctly located.
10. Now you are ready to print, press "play". Once the print has finished, the Computer will show "print 100% complete" and will stop. Don't remove the hood during the print or the print will stop.



Cleaning the machine and your printed objects

These steps will reduce any resin spillage and keep your machine clean.

1. Go to “control” and move the platform up enough so the base of your object is clear of the vat. Remove the hood on the print platform. Tilt the platform backwards in order for the excess resin to drip back into the vat.
2. With absorbent paper under it, remove the platform completely and set it down on a surface that will not be affected by resin. Place the hood back on immediately to protect the resin in the vat from light.
3. Remove any excess polymer with paper first. Place the platform to a washing-up bowl and remove the objects by sliding the scraper in at their base. Wash off any liquid polymer by alcohol. You can gently clean it with a soft brush or sponge, taking care not to damage it, it will not achieve full hardness until after post exposing in light. If you have an ultrasonic cleaner this will clean it without the possibility of damaging it.
4. Check it is thoroughly clean then place it in a container for 10-20 minutes in an area with bright sunlight. You can use light from a UV lamp. When it has been completely post exposed, it will be stronger and have a dry surface. You will notice that it darkens in colour as it is exposed to light. Dry it and check that it is dry, if not repeat.
5. Clean the build platform with industrial alcohol , chip off any cured resin and dry it before inserting it back into the printer.
6. You should empty the vat and clean it every time in case you have any solid pieces on the bottom, as these would prevent the platform from homing correctly. Loosen the Z brackets and remove the vat from the printer, pour the resin back into the bottle through a strainer. Place the vat on a flat surface and wipe the base of the vat with absorbent paper. Make sure it is clean and not damaged. If it is not flat, clean and tight like a drum, remove the film and replace it with a new piece.
7. If you have a leak on the screen it is easy to remove the hardened resin without damaging the screen by shipping it off with a blunt non-serrated knife.

AFTER SALES SUPPORT



86-571-23290996



support@wanhao3dprinter.com

Model : Duplicator 7



Detailed Creation workshop software instructions

System Compatibility

Creation Workshop is a .NET 3.5 application written in C#. This is native to the Windows Operating System, but it also runs on many versions of Linux/Posix using the Mono Framework http://www.mono-project.com/Main_Page . You will need to download and install Mono when using Creation Workshop on a Linux-based system. Windows users may need to run the application as Administrator.

Main screen

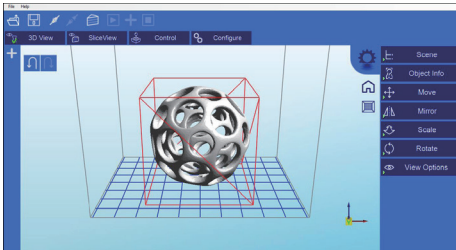

Click to open files in one of the following formats: .STL, .OBJ, .3DS or .AMF. You can also open scene files with the .CWS extension.



Click to save the current object as a .STL or .CWS file. The .CWS format allows you to prepare a scene to be printed repeatedly in the future, together with supports and positioning.



Click to start the connection between your computer and your Duplicator 7 3d printer. Once the button is grayed out, this means that the printer is connected.



Click this button to disconnect your printer from the computer. If the button is grayed out, it means that the machine is currently disconnected.





These three buttons start, pause and stop a print. These buttons only become active once you have sliced your object.



Clicking this button allows you to view the 3D objects within their boundary box. You can add supports in this function.



Clicking this button accesses the "Slicing" screen. You can see the individual slices that have been generated as well as the G-code.



This allows you to control the z axis motor, home it and lift it after a print has finished.



This is the setup screen that allows you to configure the slicing and printing profiles.

1. Loading a Model

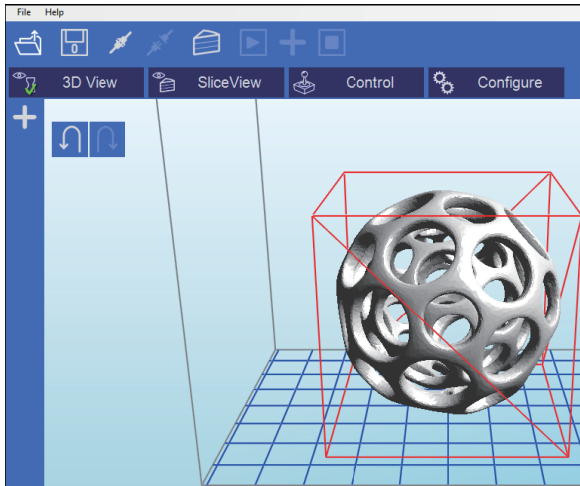

Click here to 'Load' your file. Multiple objects can be loaded and manipulated independently. You can also open scene files with the .CWS extension.

AFTER SALES SUPPORT

 86-571-23290996

 support@wanhao3dprinter.com

Model : Duplicator 7

2. Scene View

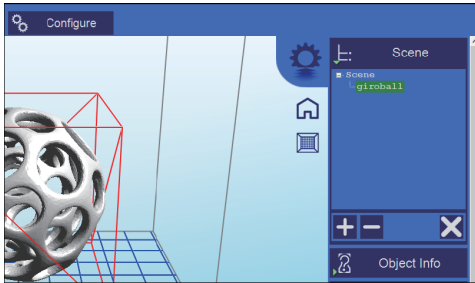

The Scene View allows you to manipulate various aspects of the scene.

Selecting

You can select a model by double clicking on the model, or selecting it with the scene view

Removing a Model

You can remove a model by right-clicking on the name in the scene graph and selecting "Remove".

The Minus sign "-" will also remove the current model.

You can also delete a model by selecting it and then pressing the "delete" key on your keyboard.

Cloning a model

You can select a model in the scene and click the "+" sign to clone it. The cloned object will appear in the scene view.

3. Object Info

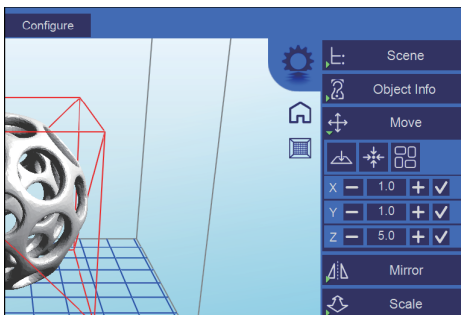

AFTER SALES SUPPORT

4. Move View

The Move function allows you to move objects on the build platform along the x:y:z axis by the distance entered.

From left to right, the other tools are:

The 'Place on Platform' button will position the bottom of the model to rest on the bottom of the build platform.

The 'Center' button will center the model at (0,0,0).

- Auto-Arrange will automatically lay out all models to fit on the build platform. Any model that does not fit within the build platform will be moved outside the build area.

5. Mirroring Objects

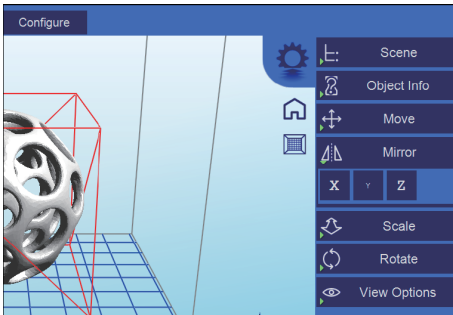

The Mirror view allows you to mirror the selected object on the specified axis.

6. Scaling objects

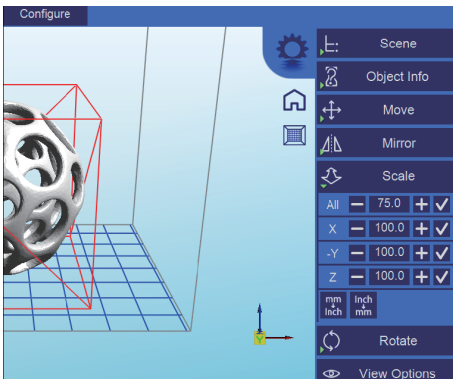

A model can be scaled (reduced or increased) by selecting it, and using the 'Scale' view to enter in a new scaler value. Press the tick button to re-scale your object.



7. Rotating Objects

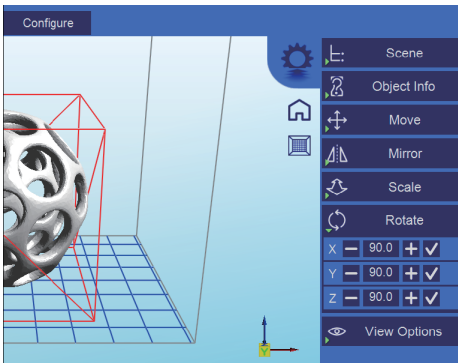

Rotating a model works in a similar way to moving a model. Simply select the model you want to work with, and use the X/Y/Z +/- buttons to rotate the model by your specified degrees.

8. View Options

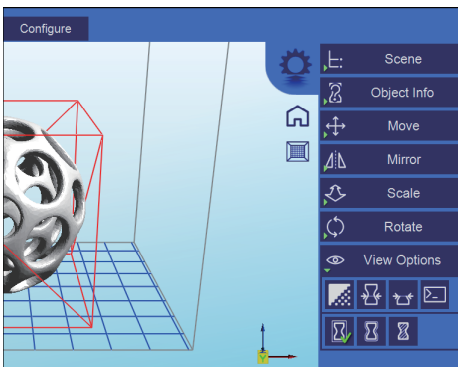

The view option allows you to manipulate various views and models.

On the top row from left to right:

- 50% Alpha-Blending toggle. This will allow you to see through the objects in the scene to see the geometry
- Show Slice Preview on Scene. After slicing this toggles on/off the view of the 3D view of the current slice layer as selected

by the horizontal scrollbar.

- Show Console. This toggle button shows or hides the debug window. This window is used for debugging purposes.

On the bottom row from left to right are tools to change the way the objects appear on the screen:

- Show objects with a bounding box.
- Show objects with an outline
- Show selected objects in a different color

9. Working with Model Support tools

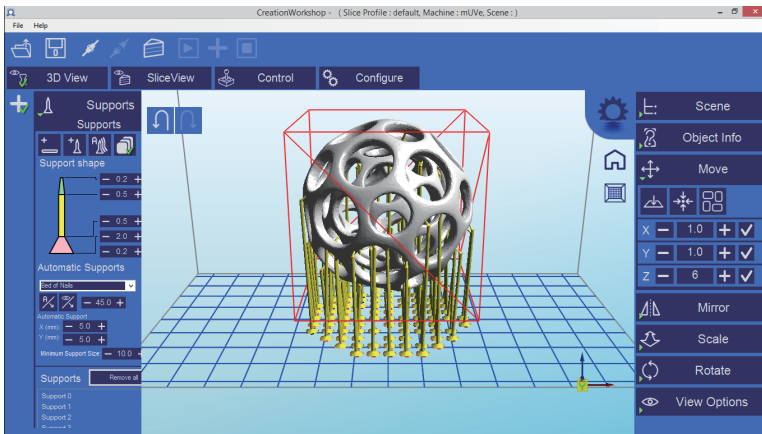
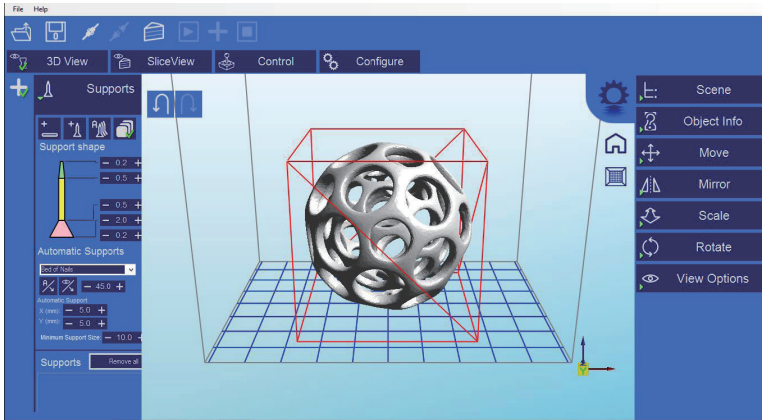

Using Supports

Supports are sometime required to properly attach a model to the build space. Because of the nature of DPP the lower layers must be supported by the supports unless it has a wide surface in the first layers.

Adding a single Support

A single support can be generated by clicking the manual support button.

Moving Supports

After a manual or automatic support has been generated, individual supports can be moved around the x:y plane the same way models can be moved. Select the support by double clicking on it to select it, and hold down the 'Shift' key on your keyboard and move the mouse. Supports will automatically scale vertically under the model they support.

Angled Supports

Supports can be angled inwards towards the objects they support. This can often resolve clearance issues with vertical supports. You can turn a vertical support into an angled support by selecting it, and holding the 'Ctrl' key and clicking on the model you want to support.

Manual Configuration

Under the Support Generation view, you can click 'show downward facing polys'. This will highlight all polygons in the model that are pointed downward by the specified degree. This helps you manually place supports under un-supported downward facing areas of a model.

Auto Support on Grid

After a model is loaded into the scene and selected, you can automatically generate a 'bed of nails' support for the model by selecting . You can specify the grid spacing and the size of the generated supports. If you wish to only generate supports on downward facing polygons, check the boxes under 'support general' and 'generate only on downward'

Adaptive supports

You can add supports to areas in the model that are unsupported. There are 2 algorithms to help you accomplish this.

10. Saving a Scene



Click to save the current object as a .STL or .CWS file. The .CWS format allows you to prepare a scene to be printed repeatedly in the future, together with supports and positioning.

After one or more models have been loaded and manipulated on the build platform, the entire scene can be saved as an STL model for later use. Simply click on the 'File->Save Scene STL' menu item to save the scene model. This will flatten all models in a scene into a single STL file. Scenes can also be saved to CWS files.. These scene files can be used to create a scene with supports, slice the scene, and later load to print your scene without the need for re-slicing.

11. Slice View

In the Slice View screen we get the following information:



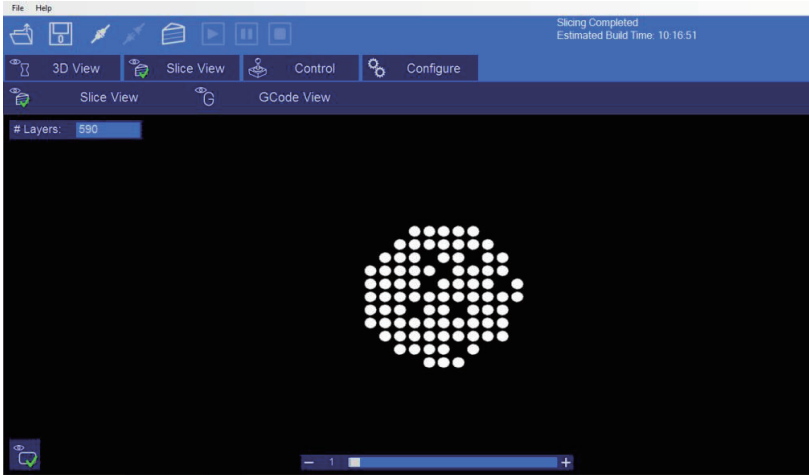

There are two buttons for each of the available options.

- The first option has the same name as the screen itself (Slice View). In this setting we can see (as shown in the image) each successive layer of the generated "Slicing". With the lower bar we can scroll through the entire slicing result to check each of the layers. In the upper left corner we can see the total number of layers that have been generated. In the lower left corner we have a () button to turn the projector on and expose the selected layer. This can be useful to check the positioning of the vat.
- G-Code View: On this screen you can see the G-code generated during the "Slicing" operation. This option is intended for advanced users. We recommend to leave this screen untouched.

12. Control

Opening the Control screen shows you the following dialogues

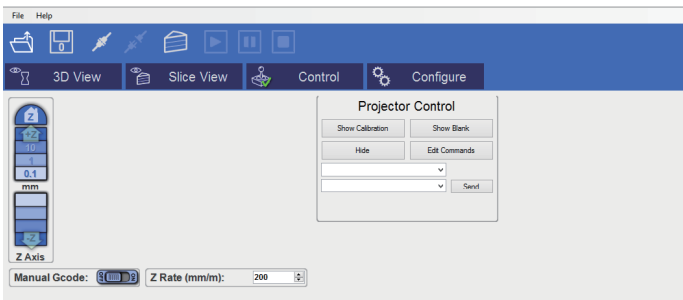

From this screen we will be able to control the motors of the printer , which means displacing the build base over the Z axis, as well as controlling the LCD.

In this section of the Control screen we have the buttons that will allow us to move the Z position of the build base. As you can see, we have 4 buttons for each direction, 50, 10, 1 and 0.1 mm. Using the value indicated as z Rate (at the bottom) you can change the speed of progress measured in millimeters / minute. We also find the home button. This is similar in function to the button that we have described above in the 3D View screen, that is, if you click it, the whole build base will rise to the detector limit, where it will seek the zeros of each axis, then descend to a lower position. The descent is done first fast then slow. This home also includes a stage where the build base raises to a higher position so as to be able to prepare the machine to pour the resin in and eave it ready to lower the base and start printing.



With this box you can control the image exposed by the LCD with the following options:

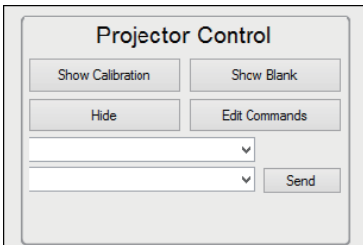

- Show Calibration: A red grid is projected. This will allow you to check if your projector is well focused -on the vat bottom.
- Show Blank: A black screen is shown, meaning a screen that won't cure the resin instantly.
- Hide: This option hides the slice projection screen, allowing the projector to display the main desktop background (the extended part).
- Edit Commands: This option allows you to edit commands to control the projector. Fields beneath this are not of recommended use.

13. Configure

13.1 Configure Machine

Machine Connection COM Port

Once a Machine profile has been selected, the 'Configure' button on the 'Machine Connection' box can be selected to show the Connection setup screen. This screen allows you to choose the correct COM port and speed to communicate with the printers' controller card via serial connection.

***NOTE** – The current version of the application will allow connections up to **115200 bps**. Please ensure your controller firmware is configured for the speed chosen.



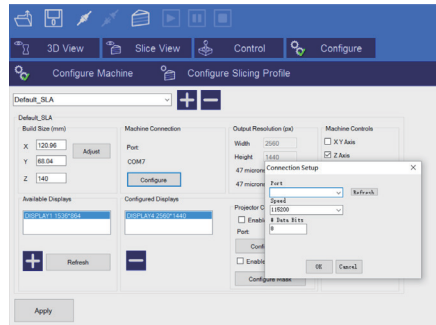
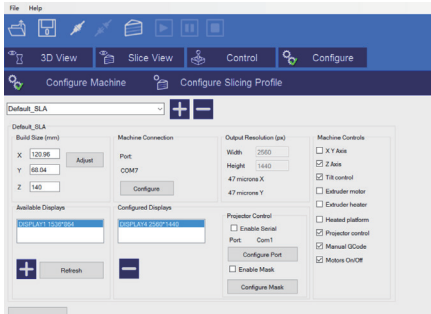

Setting up display devices

Available Displays

This shows you the available configured and connected displays on the system. You can click the Refresh button to refresh the list of displays. The '+' button will add a display to the Configured display box.

Configured Displays.

This area shows the displays that will be used for projection on the system. Once a display is added to this area, it can be selected to configure the LCD controls. Typically, only one display is used. Creation Workshop can support 2 projectors – each with the same resolution and projection size either in a horizontal or vertical format.

Machine Controls:

There is a column of check boxes on the right hand side of the machine configuration screen. Enabling these allows you to customize the controls that appear on the 'Manual Control' screen. Select the controls that are appropriate for your machine.

- Machine Controls

 - X Y Axis
 - Z Axis
 - Tilt control
 - Extruder motor
 - Extruder heater
 - Heated platform
 - Projector control
 - Manual GCode
 - Motors On/Off
 - Shutter

The ones shown in the screen show are the ones suggested to start working with the LCD printer.

Saving your changes

After you have configured your machine profile, be sure to click the “Save Changes” button to save and apply the changes.

13.2 Configure Slicing Profile

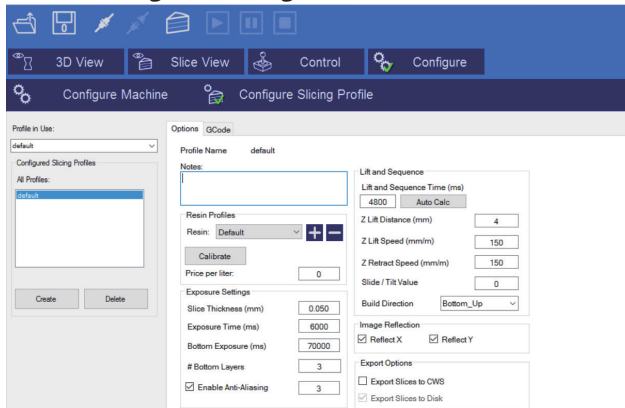

In order to slice a model into images, you must first set up a slicing profile. A default profile has been created the first time the application was started. You can create new slicing profiles and manage them in much the same way you can manage machine profiles. The ‘Slice Profiles Config’ tab item will allow you to create, delete, or edit a slicing and building profile.

On the left side of the screen we can see the following:

- o Profile in Use: In this drop down box we can select the profile we are currently using, within a list of previously available profiles. The software come preloaded with a number of preset profiles based on our resins. We recommend using the XY resolution of 100 μ m. With this profile you can perform your first printouts with the test figures provided.
- o Configured Slicing Profiles: In this dialogue we can see the list of all profiles that are available. The program comes preloaded with several profiles created at different types of resolution (100 and 50 μ m) and for different resins. We will keep updating the profiles and sharing the files online at “support”. We expect these profiles to be enough as there may be prints that vary in complexity and layer thickness. You can also create a new profile using the button or delete one by pushing the button. If



WANHAO

you want to create a new profile, carefully read the section "Creation of new printing profiles".

Slice Thickness: This field is to set the thickness of each slice in mm. The default is .05mm (20 slices per mm)

Exposure Time per Layer: This time value specifies how long the projector will display an image slice on a per-layer basis.

Bottom Layer exposure time: In order to ensure the model is properly adhered to the bottom of a vat, a longer exposure time can be used for a specified number of bottom layers.

Bottom Layers: This specifies the number of 'bottom layers' that receive the longer exposure time.

Blanking time between layers: This is a time delay that allows the machine to perform a 'Lift/tilt/slide'. You may have to experiment with this value to determine a proper timing for your machine.

Resin Price per liter

You can specify the cost of the resin used here. This is used to calculate printing costs under the 'File->Calculate Volume & Costs' menu item.

Lift and Sequence Time:

This time specifies in milliseconds how long the lift and retract sequence takes. You can use the "Auto Calc" button to generate a time estimate for the lift and retract. This value may need to be modified based on the speed of your machine.

Lift Distance: This is the distance that the printer will raise and lower the Z axis after the exposure has taken place.

Z Lift Speed:

When a layer is printed on a bottom up machine, a large amount of force may be required to separate the slide from the vat. This speed indicates how fast to perform the lift, a slower speed may be required to help vat separation.

Z Lift Retract speed:

After the lift occurs, this speed indicates how fast the z axis should travel back to the initial start position.

Slide/Tilt Value: for machine with a slide or tilt mechanism connected to the X axis, this value specifies how much to move in conjunction with the Lift.

X/Y Pixel Offset: This X/Y value allows you to offset the rendered image by a pixel amount.

AFTER SALES SUPPORT



86-571-23290996



support@wanhao3dprinter.com

Model : Duplicator 7

Build Direction: Top down or Bottom up. This value determines which direction the Lift occurs. For a bottom up machine, this is used to peel the model from the bottom of the build vat, sometimes in conjunction with a tilt/slide. For a Top-down machine, this makes the lift operation dip into the resin.

Image Slice Export Options

This allows you to control how the generated image slices and gcode files are saved. You have the option of exporting to Zip file or to a subdirectory when the 'Export Images and GCode' button is checked. If this is left unchecked, slices and gcode will still be generated, but not saved to disk.

14. Slicing a Model

Once you have loaded one or more models, configured your machine profile, and configured your build & slicing profile, you can slice a model. Choose the Slice Icon from the toolbar to bring up the Slicing Screen.



You can change the currently selected slicing profile to use.

Click the 'Slice' button to begin slicing. You can stop slicing by pressing the 'Cancel' button. If your slicing profile is configured to export images, a progress bar will appear here. Otherwise, just the gcode for the scene will be generated and the images will be rendered during build-time.

15. Connecting Software to Duplicator 7

You can connect to your 3d printer with the 'Connect' toolbar item. Please ensure that you're properly configured your machine profile as well as setting up the correct COM port before connecting.





3D Printer

Repair and Refurbished Goods or Parts Notice

Unfortunately, from time to time, faulty products are manufactured which need to change components or return to the Supplier for repair

Please be aware that if your product is capable of retaining user-generated data (such as files stored on a computer hard drive, telephone numbers stored on a mobile telephone, songs stored on a portable media player, games saved on a games console or files stored on a USB memory stick) during the process of repair, some or all of your stored data may be lost.

We recommend you save this data elsewhere prior to sending the product for repair.

You should also be aware that rather than repairing goods, we may replace them with refurbished goods of the same type or use refurbished parts in the repair process.

Please be assured though, refurbished parts or replacements are only used where they meet WANHAO's stringent quality specifications.

If at any time you feel your repair is being handled unsatisfactorily, you may escalate your complaint. Please telephone us on 86-571-23290996 or write to us at:

WANHAO Precision Casting Co.,Ltd
77, RENMING ROAD, JINHUA, CHINA
WANHAO Help Desk 86-571-23290996
(Operating Hours: Mon - Sat; 8:00am - 5:00pm)
support@wanhao3dprinter.com
www.wanhao3dprinter.com

AFTER SALES SUPPORT

 86-571-23290996

 support@wanhao3dprinter.com

Model : Duplicator 7



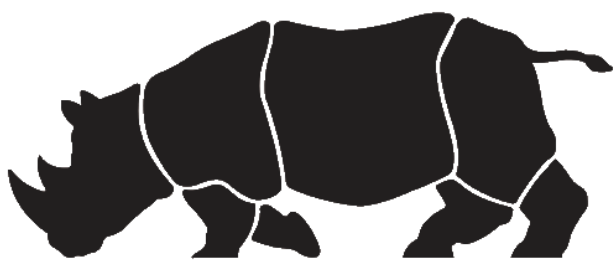

WANHAO