

New Model!



A Green Power® Juice Extractor
COMPLETE GUIDE TO

GREEN STAR JUICE EXTRACTOR



TECHNOLOGY

TWIN GEAR

WITH EXCLUSIVE
HEAVY DUTY



OPERATION MANUAL

- INSTRUCTIONS
- WARRANTY
- OWNERSHIP REGISTRATION
- IMPORTANT SAFETY INSTRUCTIONS
- DO'S AND DON'TS
- WHEN YOU NEED SERVICE
- RECIPES

SAVE THIS MANUAL-KEEP IT HANDY FOR QUICK REFERENCE

Congratulations! You are now the proud owner of a Green Star® Juice Extractor – the ORIGINAL Twin Gear Juice Extractor. With Green Star, you can juice a wide variety of fruits and vegetables – from carrots and apples, to wheatgrass and pine needles, all without having to stop and change any parts! You can also use your Green Star Juice Extractor to make other delicious foods such as pastas, baby foods, breadsticks, nut butters, pâtés, frozen fruit sorbets, and much more!

The revolutionary Heavy Duty Twin Gear design incorporates an impeller press system that rotates at a low 110 rpm and generates little heat while juicing. The patented twin gears also have magnetic and bioceramic technology that produces fresher juice that can be stored longer, with minimal loss of the precious enzyme and vitamin content in the juice.

After unpacking your Green Star and checking that all of the specified parts are there, take some time to become familiar with your new juicer before you start juicing. It is a good idea to disassemble and reassemble your machine a few times to become familiar with how all of the parts fit together properly. Many parts have been included as standard parts to make your juicing experience easier and to enhance the versatility of the food preparation capabilities.

We recommend that you rinse all of the parts in lukewarm water before you first use your Green Star Juice Extractor. Now you are ready to begin juicing with your Green Star Juicer. We hope you enjoy your Green Star experience, as it helps you embark on your journey to better nutrition and better health.

TABLE OF CONTENTS

Warranty	4
Warranty Registration Card	Insert
When You Need Service	5
Important Safety Instructions	6
Do's and Don't's	7
Green Star Juice Extractor Features	
Standard Parts	8
Parts Order Form	10
Assembly and Disassembly	11
Setting Up Your Green Star	
Screens and Plastic Plunger	15
To juice Wheatgrass	15
To make Pasta, Rice Cake (mochi), Bread Sticks, Bagels, etc.	16
Cleaning and Maintenance	17
Troubleshooting	18
Helpful Hints	19
Recipe Index	22
Juices and Drinks	23
Bread Sticks and Mochi (Rice Cakes).....	27
Pasta and Noodles	28
Pâté and Croquettes	29
Soups	30
Desserts	31

WARRANTY (Please read carefully)

We warrant to you, the end-user customer who has properly registered after purchasing the Green Star Juice Extractor (hereinafter referred to as "GS") for a valuable consideration, that the plastic parts, motor and the Twin Gears of this GS will be free from defects in materials and workmanship for a period of five (5) years from the date of purchase. All other parts, including, but not limited to, the Juice Pitcher, Cleaning Brush, Wooden or Plastic Plunger, and the Strainer are not subject to any warranty.

In order for you to receive the benefits of this warranty, you are required to register for warranty service by (a) completing and mailing the warranty registration card (next 2 pages) to us within ten (10) days following the purchase of your GS, or (b) registering online at www.greenstar.com.

1. No warranty will be provided until after we have actually received the proper registration, with all of the requested information, within ten (10) days of the date of the original purchase. The warranty is only good for the original purchaser for value. This warranty is non-transferable.
2. If the GS exhibits defects while in normal household use, we will, upon our actual receipt of a written notice of such defects from you during the warranty period, either repair or replace, at our option, the GS that has verifiable manufacturing defects. However, we have no such obligation to repair or replace the machine until after you have, by insured mail and in properly protective packaging*, delivered the GS to the location of your service center as set forth on page 5. Replacement GS may be either new or like new. Repaired GS may contain re-manufactured or re-conditioned parts, which are equivalent to new in performance or may have been subject to incidental use.
3. We do not warrant that the operation of the GS will be uninterrupted or error-free. In no event shall our liability exceed the retail value of the GS.
4. All warranty and repair services must be performed at a warranty service center, which is located within the country where the GS was originally purchased. However, in the event that: [I] the machine must be serviced at a service center, which is not located within the country where the machine was purchased; or [II] there is no service center within the country where the machine is located and must be shipped to a service center in another country, then those service centers are responsible for the parts and service only, and any and all costs relating to the shipping, delivery and handling of the machine to and from those service centers shall be the sole responsibility of the owner.

This Warranty does not cover damage resulting from: [a] failure to operate the GS in accordance with the instructions; [b] the use of parts or supplies not provided or authorized by the manufacturer; [c] negligent, improper or inadequate maintenance; [d] service performed or attempted by unauthorized service person; [e] damages, accidental or otherwise to the GS, which are not directly caused by us or the manufacturer; or [f] damages resulting from abuse, tampering, misuse, commercial use, or unauthorized modification of the GS.

WE MAKE NO OTHER EXPRESS OR IMPLIED WARRANTY OR CONDITION WHETHER WRITTEN OR ORAL. TO THE EXTENT ALLOWED BY LOCAL LAW, ANY IMPLIED WARRANTY OF FITNESS FOR A PARTICULAR PURPOSE OR IMPLIED WARRANTY OR CONDITION OF MERCHANTABILITY IS LIMITED TO FIVE (5) YEARS. In the event that such limitation or exclusion on the duration of an implied warranty is not allowed in the state or county wherein you reside, the above limitation or exclusion may not apply. This warranty gives you specific legal rights and protection, and you may also have other rights that vary from state to state, or county to county.

TO THE EXTENT ALLOWED BY LOCAL LAW, THE REMEDIES IN THIS WARRANTY STATEMENT ARE YOUR SOLE AND EXCLUSIVE REMEDIES. EXCEPT AS INDICATED ABOVE, IN NO EVENT WILL WE BE LIABLE FOR DIRECT, SPECIAL, INCIDENTAL, CONSEQUENTIAL (INCLUDING LOST PROFIT), OR OTHER DAMAGE, WHETHER BASED IN CONTRACT, TORT, OR OTHERWISE. Some states or counties may not allow the exclusion or limitation of incidental or consequential damages. If you reside in such a state or county, the above limitation or exclusion may not be applicable.

Do not send your GS back to the service center without return authorization.

*** Save Original Shipping Box**

Place
Stamp
Here

Green Star Juicer Registration:

TRIBEST CORP.

P.O. Box 4089

Cerritos, CA 90703

USA

- Do you have Internet Service?
 Yes No

- Have you ever purchased any products through Internet Stores?
 Yes No

- Do you use e-mail at work?
 Yes No E-mail Address _____

- Do you use e-mail at home?
 Yes No E-mail Address _____

- Please check all that apply to your household
 - Regularly Purchase Items Though the Mail
 - Military Veteran in Household
 - Member of Frequent Flyer Program
 - Support Health Charities
 - Subscribe to Cable or Satellite TV
 - Have a Microwave Oven
 - Have a CD Player
 - Have a VCR
 - Have a DVD Player
 - Have a DVR
 - Use a Personal Computer

Thank you for taking the time to fill out this questionnaire. Your answers will be used to help us better serve you in the future. Periodically, we would like to send you important product information and special offers. Be assured, your privacy is important to us and your information is never shared or sold to third parties unless it is required for us to conduct regular business with you, or unless it is required by law.

Please initial here if you would not like us to send you important product updates and announcements: _____

If you have comments or suggestions
about our product, please write to:

Green Star Customer Relations, P.O. Box 4089, Cerritos, CA 90703

WHEN YOU NEED SERVICE

In the unlikely event that you need service on your GREEN STAR JUICE EXTRACTOR, or if it fails to function properly while within the warranty period during normal household operation, contact the Green Star Warranty Service Center.

SERVICE CENTERS

****For all service inquiries, please first contact the Main Service Center for a return merchandise authorization (RMA) number and proper routing instructions****

Main Service Center

Tribest Corporation
1143 North Patt Street
Anaheim, CA 92801
TEL : 888-254-7336
FAX : 714-879-7140

Regional Service Centers

West

3800 Happy Lane, Suite A
Sacramento, CA 95827-9721

East

47 Miry Brook Road
Danbury, CT 06810

Midwest

21355 Highway 179
Jamestown, MO 65046

If you need service:

- 1 Call the Main Service Center (888-254-7336) to get a return merchandise authorization (RMA) number to send your unit to the service center. Returns will NOT be accepted without an RMA number clearly written on the box.
- 1 Pack your Green Star securely in the original shipping box. Make sure all affected parts are enclosed.
- 1 Fill out the service request form below, detach it and enclose it in the shipping box.
- 1 Seal the shipping box securely with packing tape.
- 1 Address the box to the service center. Be sure to put your return address on the outside of the package.
- 1 It is always wise to insure the package against possible damages or loss in transit. Ship prepaid.

----- *Detach Form on dotted Line* -----

SERVICE REQUEST FORM

First Name _____ Initial _____ Last Name _____

Address: Street _____ Apt # _____

City _____ State _____ Zip _____

Phone (____) _____ - _____

Serial# _____ Model # _____

Date of Purchase _____ Place of Purchase _____

Name of parcel/post carrier (In case of damage during delivery) _____

Reason for service request (use additional paper if more space is needed) _____

IMPORTANT SAFEGUARDS

When using electrical appliances, basic safety precautions should always be followed including the following:

1. Please read all instructions carefully.
2. To protect against risk of electric shock, do not put the motor base in water or any other liquid.
3. Close supervision is necessary when any appliance is used by or near children.
4. Unplug the appliance from the electrical outlet when not in use, before assembling or disassembling and before cleaning.
5. While the machine is in operation, avoid touching its moving parts.
6. Do not operate any appliance with a damaged cord or plug; or after the appliance malfunctions, is dropped or is damaged in any manner. Return the appliance to the nearest authorized service center for examination and possible repair to prevent electrical shock or injury.
7. The use of attachments not recommended or sold by the manufacturer may cause fire, electrical shock or injury.
8. Do not use outdoors.
9. Do not let the cord hang over the edge of a table or counter.
10. Do not let the cord come in contact with any hot surfaces such as the stove.
11. Always make sure the two latching arm knobs are fastened securely in place before the motor is turned on. Do not unfasten the knobs while the juicer is in operation.
12. Be sure to turn the switch to the "OFF" position after each use. Make sure the motor stops completely before disassembling.
13. Do not put your fingers or other objects into any juicer openings while it is in operation. If food becomes lodged in the feeding chute, use the wooden plunger or another piece of fruit or vegetable to push it down. When this method is not possible, turn the motor off and disassemble the juicer to remove the remaining food.
14. For household use only.
15. Please refer to INSTRUCTIONS before operating.
16. Please refer to "When You Need Service" in case your juicer is functioning abnormally.
17. Do not disassemble any parts other than those necessary for normal operation or cleaning of your juice extractor (such as housing, twin gears, screen).
18. Your Green Star Juice Extractor must be grounded electrically for proper, safe operation. Use only the 3-prong plug provided. Or use a proper plug or adapter according to the electrical safety code in your country.
19. Do not use the appliance for other than its intended use.
20. Always make sure that all juicing parts are fastened in place by the latching arms and that the latching arm knobs are tightened securely before the motor is turned on. Do not loosen latching arms while the machine is in use.

SAVE THESE INSTRUCTIONS

DO'S AND DON'TS

DO :

- Very important! When combining the Twin Gears for assembly make sure to align the locating dots marked on the surface of the gears.

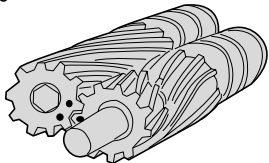

- Soak grains in water for 6 hours or more. Drain the grain and put into the machine a little at a time, together with a small amount of water.

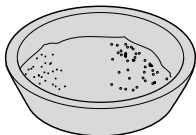

- When you operate your Green Star Juice Extractor continuously, stop operation for 10 minutes after each 30 minutes of use, and then resume operation.

10 minutes of rest after
30 minutes of operation

- Always put the Feeding Chute into the Twin Gear Housing before using. Directions for assembling the Feeding Chute can be found on page 11.

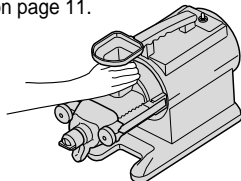

DON'T :

- Do not lift your Green Star Juice Extractor with wet hands because it is heavy and it may accidentally slip from your grip.

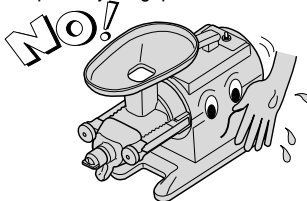

- Do not keep the juice extractor where children can reach it.

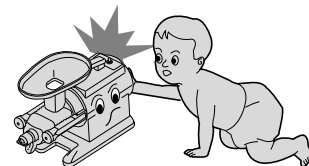

- Do not assemble or disassemble while the power cord is plugged in.

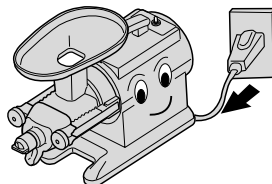

- Do not put any articles such as knives, spoons, or forks into the Feeding Chute.



- Do not put fingers or hands into the Feeding Chute. Always use the Plunger.

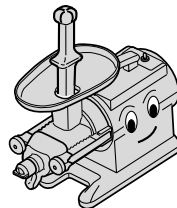

- Do not operate Green Star Juice Extractor on an unstable surface.

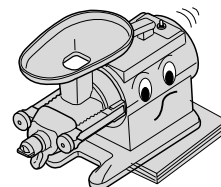

- Do not disconnect the power plug from the electrical outlet with wet hands.

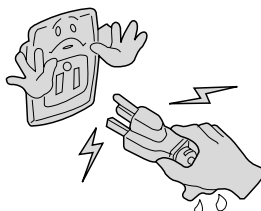

- Do not forcibly operate the juice extractor or overload the Feeding Chute.

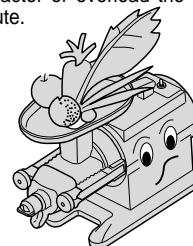





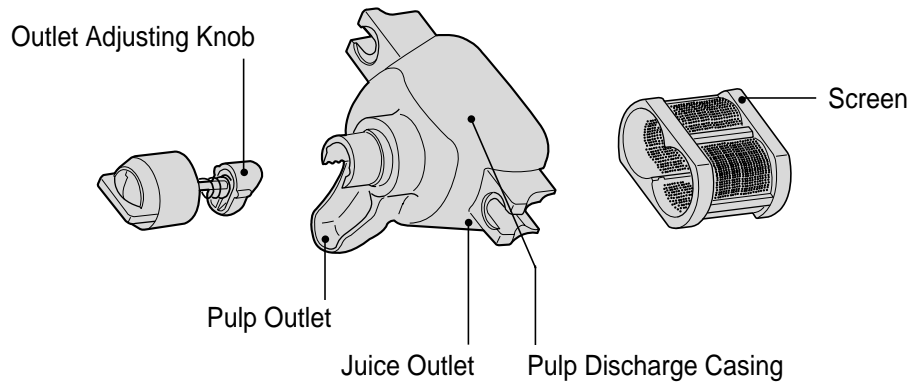



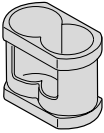
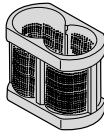



WARNING : NEVER REMOVE THE TOP SECTION OF THE FEEDING CHUTE WHILE THE JUICER IS IN USE

GREEN STAR JUICE EXTRACTOR

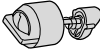

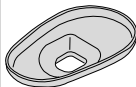

Standard Parts for GS-1000:

Homogenizing Blank (Open Blank) CJST1-032A 	Fine Screen CJST1-034A 	Juice Pitcher CJST1-040A 	Cleaning Brush CJST1-039A 	Plastic Plunger CJGP5-036A 	Wooden Plunger CJST1-038A 	Drive Gear CJST1-044A 	Free Wheel Gear CJST1-045A 
Twin Gear Housing CJGS5-024A 	Pulp Discharge Casing CJGS5-028A 	Outlet Adjusting Knob CJGS5-026A 	Latching Arm Knob CJGP5-006A 	Safety Tray CJGP5-037A 	Feeding Chute CJGP5-027A 	Feeding Chute Cover CJGP5-025A 	

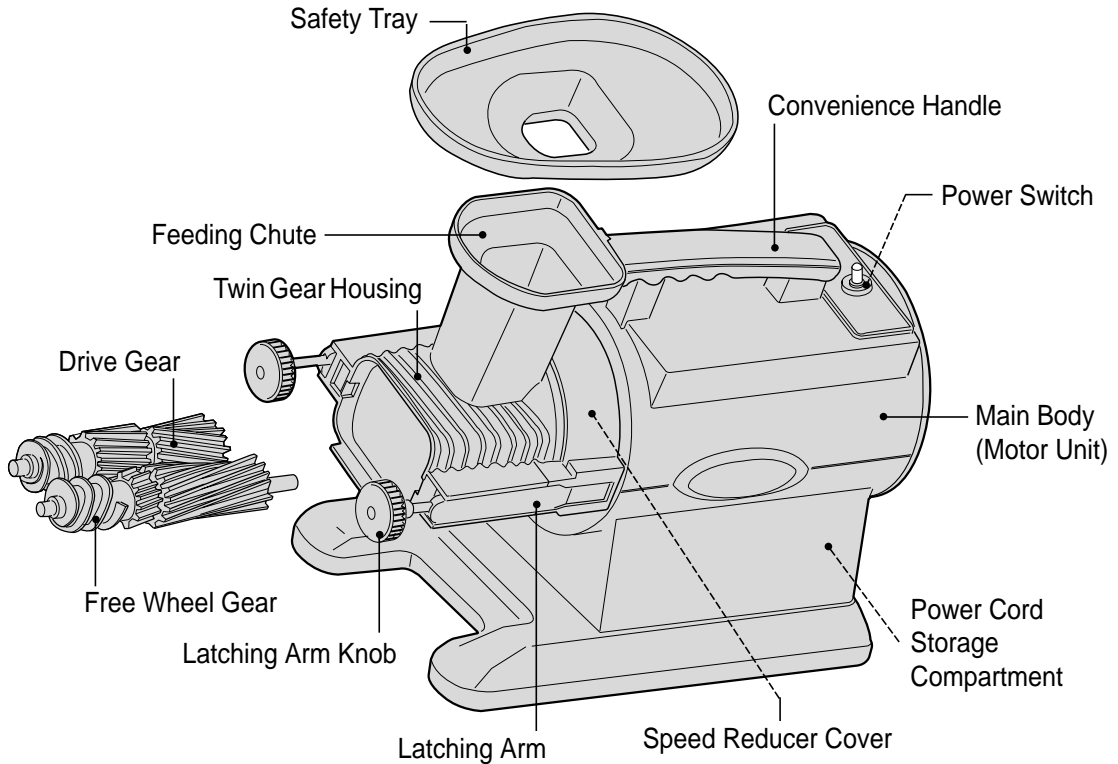

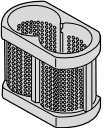

FEATURES AND PARTS

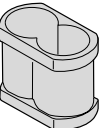

GS-2000 includes GS-1000 parts, plus:

Coarse Screen	S/S Strainer	Drip Tray
CJST1-035A	CJST1-042A	CJGP5-038A
		

GS-3000 includes GS-2000 parts, plus:

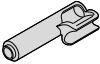
Bread Stick Blank (Closed Blank) CJST1-033A	Bread Stick Guide CJGS5-042A	Pasta Screen CJGS1-041A	Pasta Screw CJST1-030A	Pasta Guide CJST1-031A
				

Optional:

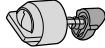
Outlet Adjusting Knob – Soft Fruit CJGS5-027A

GREEN STAR PARTS:

GREEN STAR PARTS & Order Form (please call your service center for parts prices)

NO. Ordered	Part Number	Standard with GS-	Unit Price	Quantity	Total
	Main Body With Motor	CJGS1-037A	1000/2000/3000		
	Twin Gear Housing	CJGS5-024A	1000/2000/3000		
	Pulp Discharge Casing	CJGS5-028A	1000/2000/3000		
	Outlet Adjusting Knob-Regular	CJGS5-026A	1000/2000/3000		
	Drive Gear	CJST1-044A	1000/2000/3000		
	Free Wheel Gear	CJST1-045A	1000/2000/3000		
	Fine Screen	CJST1-034A	1000/2000/3000		
	Homogenizing Blank	CJST1-032A	1000/2000/3000		
	Juice Pitcher	CJST1-040A	1000/2000/3000		
	Wooden Plunger	CJST1-038A	1000/2000/3000		
	Plastic Plunger	CJGP5-036A	1000/2000/3000		
	Cleaning Brush	CJST1-039A	1000/2000/3000		
	Safety Tray	CJGP5-037A	1000/2000/3000		
	Coarse Screen	CJST1-035A	2000/3000		
	Stainless Steel Strainer	CJST1-042A	2000/3000		
	Drip Tray	CJGP5-038A	2000/3000		
	Bread Stick Blank	CJST1-033A	3000		
	Bread Stick Guide	CJGS5-042A	3000		
	Pasta Screen	CJGS1-041A	3000		
	Pasta Screw	CJST1-030A	3000		
	Pasta Guide	CJST1-031A	3000		
	Outlet Adjusting Knob-Soft Fruit	CJGS5-027A	Optional		
Assorted Sets					
	Twin Gear Set	Includes 1 Free Wheel Gear & 1 Drive Gear			
	Pasta Set	Includes 1 Pasta Screen, 1 Pasta Screw & 1 Pasta Guide			
	Bread Stick Maker Set	Includes 1 Bread Stick Blank & Bread Stick Guide			
			Subtotal		
			TAX (CA residents, add 7.75%)		
			Shipping/Handling		
			Total Enclosed		

Payment Method

_____ Check/Money order payable to **Tribest** enclosed.

_____ Visa / MasterCard / Discover / Amex

Card Number

□□□□ □□□□ □□□□ □□□□

Expiration

□□ / □□

Card Holder's Name _____

Authorized Signature _____

Date _____

Business Name :

Billing Address :

Shipping Address (if different from billing) :

Phone Number :

Call (714) 879-7150 for pricing information and send this order form along with your method of payment in a stamped envelope to the nearest Green Star Service Center or to: Tribest Corp., P.O. Box 4089, Cerritos, CA 90703.
DO NOT SEND CASH!

GREEN STAR ASSEMBLY

Safety Reminder: Make sure to unplug the machine before assembling.

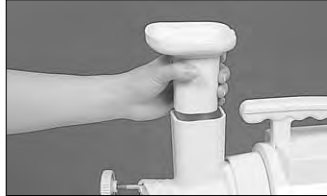

1. Slide the **Twin Gear Housing** onto the main body with the Latching Arm Knobs loosened and the Latching Arms open.

Insert the Feeding Chute into the Twin Gear Housing “neck”, with the small rectangular tab toward the rear of the machine.

Note : Before putting your machine away for future use, cover the Feeding Chute with its protective lid once it has been cleaned and dried. Simply place the Feeding Chute Lid on top of the Feeding Chute, with the two “ears” pointing to the sides of the juicer and the oval end of the lid toward the front of the machine. Gently push it down into position. Remove lid before using the juicer.



Drive Gear Free Gear



Position the 1 dot between the 2 dots and insert them into the twin gear housing.



2. Very Important!

Assemble the **Twin Gears** as follows:
Find the ‘**Locating Dots**’ marked on the end surface of each gear. Position the single dot on one gear between the two dots on the other gear. Holding the Twin Gears in this position, and with the **Free Wheel Gear** on the right, slide them into the **Twin Gear Housing**. Once the gears come to a stop, slowly turn the gears and continue to push in until the gears lock into position.

Hint : To check whether the Twin Gears are seated properly, try to turn the gears with your hands. If you can turn the gears, they are not seated properly. Also, look down the feeding chute – if any part of the drive shaft in front of the drive gear is visible, the gears are not seated properly. Rotate the gears while pushing them in until they lock into position.

WARNING! Failure to properly seat the Twin Gears could result in damage to the Gears and the Drive Shaft, which may not be covered under the warranty.

GREEN STAR ASSEMBLY (Cont'd)



3. Slide the desired **Screen** or **Blank** over the **Twin Gears** and into the **Twin Gear Housing**.



4. Slide the **Pulp Discharge Casing** over the **Twin Gear Housing**.



5. Close each **Latching Arm** and tighten by turning both **Latching Arm Knobs** clockwise.



6. Attach the **Outlet Adjusting Knob** by inserting it into the **Pulp Discharge Casing** and turning it clockwise until it is snug. Do not over tighten.



7. Attach the **Safety Tray** to the **Feeding Chute**.

GREEN STAR DISASSEMBLY

Safety Reminder: Make sure to unplug from the outlet before disassembly



1. Remove the **Safety Tray** by lifting it vertically from the **Feeding Chute**.



2. Turn the **Outlet Adjusting Knob** counter-clockwise until it separates from its threads; then pull it out from its grooves.



3. Turn the **Latching Arm Knobs** counter-clockwise to loosen. Open the **Latching Arms** horizontally outward on their hinges.



4. Remove the **Pulp Discharge Casing**.

GREEN STAR DISASSEMBLY (Cont'd)



5. Remove the **Screen**. The Twin Gears may come out with it. Be careful not to drop the **Twin Gears**.



6. Slide the **Twin Gears** out.

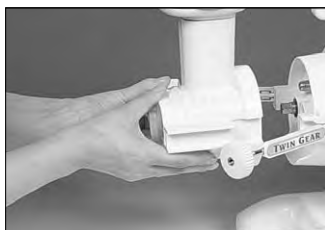

7. Remove the **Twin Gear Housing** by gently pulling it away from the body of the machine.

Note : The **Twin Gears** on your juicer never need sharpening. They are not blades that cut, chip or tear the produce – which can lead to heat that may destroy enzyme activity. Instead, the Twin Gears work by “biting” off small bits of produce at a time – much like your teeth – and does not heat up your juice.

MACHINE SETUP

Screens ----- Which Screen Do You Use?



1. **Fine Screen** - makes the clearest juice by separating the most pulp from your juice. The pressure built up inside the machine may push a minimal amount of pulp into the juice. Use to juice most types of produce, including: carrot, parsley, kale, wheatgrass, other green leafy vegetables and herbs, apples, and all other types of produce.



2. **Coarse Screen** - allows some pulp to mix with the juice. Use it any time you want more pulp to mix into your juice. (optional for GS-1000)

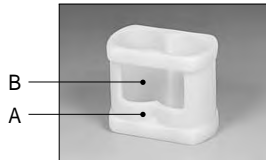

3. **Homogenizing Blank (Open Blank)** - to puree, make frozen desserts, baby foods, nut butters, apple sauce, pâté, relish, etc. Use with: grains, garlic, banana, strawberry, nuts, etc. To use the Homogenizing Blank, insert side "A" first with hole "B" facing downwards, over the Twin Gears and into the Twin Gear Housing.

Using the Plastic Plunger

The **Plastic Plunger** is specially designed to push food down the **Feeding Chute** without the plunger touching the gears. To use the plastic plunger, make sure that the safety tray is attached and press down with the plunger.

NEVER USE THE PLASTIC PLUNGER WITHOUT THE SAFETY TRAY ATTACHED.

Using the Wooden Plunger

Don't be afraid of the **wooden plunger** touching the **twin gears** while juicing. Touching the plunger to the twin gears will not harm the gears or the plunger. The plunger is made from the same high quality wood as many fine chopping blocks, so any accidental particles of cellulose scraped off by the **Twin Gears** are non-toxic and will pass harmlessly with the pulp.

Using the Drip Tray

Position the drip tray with the narrow end underneath the **pulp discharge outlet**. Rest the front two legs of the juicer on top of the corners of the wide end of the drip tray. Place the juice pitcher on top of the drip tray to collect juice.

Juicing Wheatgrass (Also Barley Grass, Alfalfa & Others)

1. Assemble Green Star with the **Fine Screen** for maximum juice extraction and pulp separation.
2. Tighten the **Outlet Adjusting Knob** completely.
3. With the power switch in the "on" position; place a handful of wheatgrass (approx. 3/4 inch in diameter) tip down, into the **Feeding Chute**.

MACHINE SETUP (Cont'd)

4. After a few drops of juice come out from the **Pulp Discharge Outlet**, loosen the **Outlet Adjusting Knob** about halfway.
5. Carrots, apples and other fruits and vegetables can be added to create a milder tasting combination for those who have not yet acquired a taste for pure wheatgrass juice.
6. If you notice excess foam, try refrigerating your gears before juicing wheatgrass, and spraying the wheatgrass with cold water before juicing.

Note: Please refer to "Wheatgrass Delight" on page 22.

Making Pasta

1. Attach the **Twin Gear Housing** to the juicer body.
2. Insert the **Pasta Screw** onto the motor drive shaft (left side as you are looking at the front of the body).
3. Put the **Pasta Guide** over the **Pasta Screw**, making sure the long side of the **Pasta Guide** faces to the left side.
4. Select the pasta type that is desired from the two shapes provided on the **Pasta Screen** and fit it onto the **Pasta Guide**.
5. Tighten the **Latching Arm Knobs**.
6. The machine is now ready to make pasta.
7. Be sure the dough is not too moist.

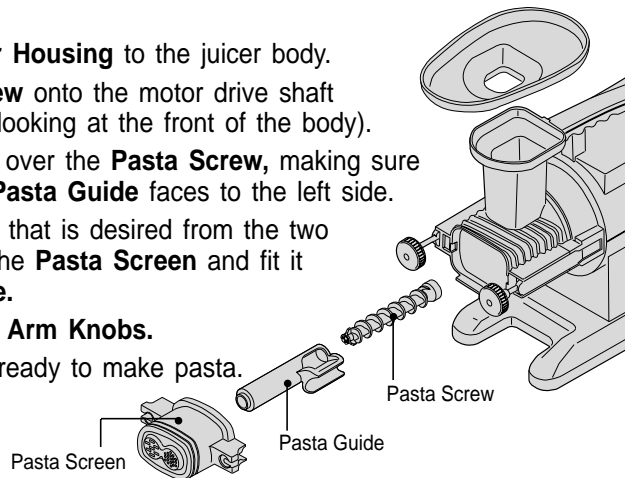

Making Breadsticks, Bagels, Rice Cakes (Mochi), etc.

1. Assemble Green Star with the **Bread Stick Blank** instead of the fine screen.
2. Attach the **Pulp Discharge Casing** to the **Twin Gear Housing**, thus locking the **Bread Stick Blank** into position.
3. Unscrew the **Outlet Adjusting Knob** (not shown here) from the **Pulp Discharge Casing** and replace it with the **Bread Stick Guide**.
4. Place the **Safety Tray** into position.
5. Add ingredients to be used into the **Feeding Chute**. Soaked grains are great for making raw 'dough'. Use cooked sticky white rice to make rice cakes.

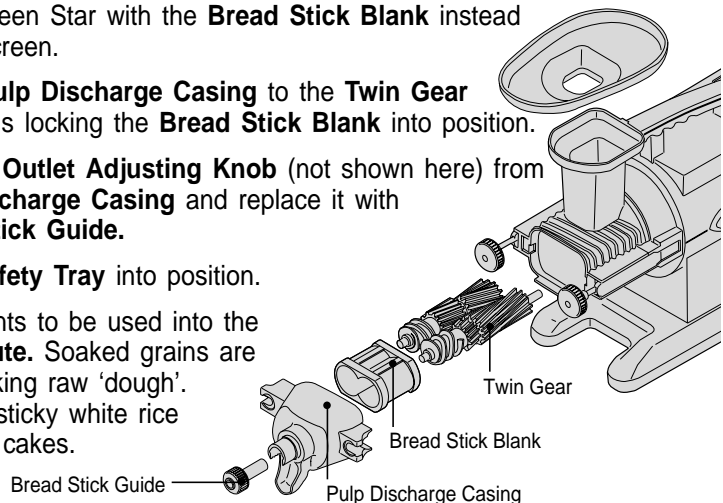

CLEANING AND MAINTENANCE

Proper Cleaning Lengthens the Lifespan of the Juice Extractor

- Since the GS extracts minerals, such as calcium, from the produce so well, we recommend cleaning all of the juicer parts immediately after use to prevent mineral build-up, which can cause problems.
- Completely disassemble the **Pulp Discharge Casing** and **Twin Gear Housing** sections. Immerse them in water and clean them with the **Cleaning Brush**, which is provided for your convenience.
- After cleaning the juice extractor, let it air-dry thoroughly.

To Remove Calcium and Mineral Deposits from the Twin Gears

- After using the machine for some time, you may notice a calcium or mineral deposit on the surfaces of the **Twin Gear** unit. To remove calcium or mineral deposits from your Twin Gears: After juicing carrots, feed some of the carrot pulp back through the machine and then add some granulated sugar (Ratio: one tablespoon of carrot pulp to one or two teaspoons of granulated sugar). Alternate pulp and sugar several times and then run the machine. Make sure to disassemble and thoroughly clean all of the juicing parts.

Cleaning Green Star

- Make sure the machine is switched off and unplugged from the wall. Store the cord in the **Cord Storage Compartment**.
- Because your **Green Star Juicer** extracts calcium and other minerals from the fruits and vegetables, it is essential to wash your juicer parts immediately after use; otherwise, mineral deposits may form and cause problems.
- Rinse and scrub your parts under warm running water and use a mild detergent to clean the parts.
- Disassemble the juicer as shown on page 13-14 and immerse each component in lukewarm water. Clean out all the pulp with the multipurpose **Cleaning Brush** provided, using the thinner end to force out the pulp, which normally collects in the **Pulp Discharge Outlet**.
- When using the **Fine Screen**, brush away from the corners, avoiding a build-up of pulp, which will be difficult to remove later.
- Under no circumstances should you allow water to enter the main body of the machine. Please refer to HELPFUL HINTS (page 20).
- Rinse all soapy water from the components; dry them thoroughly before they are reassembled.
- You will notice that some of the inside surfaces may get stained during operation by natural pigments found in your vegetables. This is considered normal, and may not be able to be removed.
- NEVER use harsh chemicals, such as bleach, to remove food stains from the juicer.
- NEVER drop any of the components, particularly the **Twin Gears**. Our warranty does not cover accidental damage.
- Do not put any parts into the dishwasher.

TROUBLESHOOTING

Symptom	Solution
Machine doesn't turn on	<ul style="list-style-type: none"> - Make sure the power supply is active, the plug is correctly positioned in the electrical outlet and the machine is switched on. - Check the fuse, and replace if necessary.
Machine stops while running	<ul style="list-style-type: none"> - Make sure the machine is correctly assembled. - If the machine is overloaded, use the reverse switch to dislodge some of the ingredients. - If the material you are trying to process is cut too large or is too hard, try using the reverse switch to clear the machine. - Check the fuse, and replace if necessary.
Noisy gears	<ul style="list-style-type: none"> - Make sure the Twin Gears are correctly aligned. - Check to see if there is any hard material lodged in the gears. If so, disassemble the machine, rinse and try again.
Pulp discharge casing doesn't fit properly	<ul style="list-style-type: none"> - Check to see if the Twin Gears are seated properly. Give them a twist while pushing in until they lock into place.
Pulp discharge casing begins shaking	<ul style="list-style-type: none"> - Tighten the Latching Arm Knobs
Pulp is not being ejected; Ingredients are coming back up the feeding chute	<ul style="list-style-type: none"> - Loosen the Outlet Adjusting Knob
Pulp is too wet	<ul style="list-style-type: none"> - Tighten the Outlet Adjusting Knob
Pulp comes out with juice	<ul style="list-style-type: none"> - Make sure the screen is in position
Low amount of juice	<ul style="list-style-type: none"> - Tighten the Outlet Adjusting Knob
Material jammed	<ul style="list-style-type: none"> - Flip the switch to the reverse position once or twice. - If it doesn't clear, disassemble the machine to clear any blockage.

Changing the Fuse

1. Unplug the juicer and store the cord in the Cord Storage Compartment.
2. Locate the square plate on the bottom of the GS Juice Extractor. Using a small Phillips Head screwdriver, remove the two screws that hold the plate in position. Remove the square plate.
3. Find the round, capsule-shaped, milky-colored fuse casing. There is a white wire extending from each end of the capsule.
4. Grasp one end of the fuse casing between your thumb and forefinger of one hand; and the other end of the fuse casing in the other hand. Push both ends toward the center and twist to open the fuse holder. Release both ends.
5. Remove the old fuse from the casing and discard properly. Place a new fuse into the casing. Close the fuse casing by reversing the procedure in Step 4, above.
6. Replace the square bottom plate and the two screws to secure to plate. If your Green Star Juice Extractor still experiences problems after troubleshooting, please contact your nearest authorized service center.



Green Star requires special repair procedures. Repairs beyond the scope of the Troubleshooting Chart should never be attempted by anyone other than an authorized service center. Repairs made other than by an authorized service center will void your warranty.

If the machine has stopped running, please wait 10 minutes and try turning it on again.

In the unlikely event that the Feeding Chute becomes jammed while juicing or processing any food items:

- A. Put the "ON/OFF" switch in the "REVERSE" position to dislodge the food.
- B. If this does not work, TURN THE MACHINE OFF AND DISCONNECT IT FROM THE ELECTRICAL OUTLET (FOR SAFETY). Use a blunt tool to loosen whatever food is lodged in the Feeding Chute.

WARNING: Never stick a knife, spoon, or other foreign object down the feeding chute while the machine is in operation!

HELPFUL HINTS

NOISES

Even though the Green Star juicer is very quiet, some noises are normal during operation. If you are unsure whether the noises you are hearing are normal:

1. Completely disassemble your Green Star and turn on the motor. You will hear a normal humming motor sound. If you hear squeaking, your juicer may need lubrication between the Drive Shaft and the rubber seals. Do not be intimidated by this noise. It does not affect the juicer's performance and will not damage any other parts on your juicer. Please call your service center for instructions on how to lubricate your juicer.
2. Fully assemble your juicer and turn it on without adding any produce. You will hear the Twin Gear sound. You may hear a repetitive thumping sound, which is normal. The Twin Gears may have minor variations and the thumping sound is considered normal. This minor variation will not affect the function and will not damage any parts.
3. While you are juicing you may hear a squeaking or chirping sound that is also considered to be normal.

MOVEMENTS

A great deal of pressure is built up in the juicing chamber while in operation. In order to alleviate some of this pressure, Green Star was designed to wiggle and flex while juicing to prevent damage to other parts of the machine. The flexing is normal and will not cause damage.

JUICING

Remember that your juicer needs time - it is revolving at only 110 rpm. The most nutritious juice is made slowly, allowing the produce to come into contact with the magnetic field (focused only in the tiny space between the gears) for a maximum length of time. Also, slow juicing is gentler, creating less heat build up.

1. Carrot

The Twin Gears are not blades - you will need to firmly push carrots into the slowly rotating gears. Cut thicker carrots into lengthwise halves for easier juicing. The Plastic Plunger does not reach all the way to the gears – try using the Wooden Plunger to push that last bit of carrot for complete juicing.

2. Wheatgrass

To minimize the amount of foam produced, refrigerate the gears and wheatgrass for about 2 hours or overnight before juicing. As you are juicing, spray some cold water on the wheatgrass. If you do not mind wheat grass juice mixed with carrot juice, you will get maximum yield on the wheat grass juice with minimum foam by alternating wheat grass and carrot while juicing.

Note: Certain batches of wheatgrass may cause more foam than others! If you notice that your wheatgrass is generating excess foam, try finding a new source for your wheatgrass.

3. Leafy Vegetables

To juice leafy vegetables easily, simply roll the leaf into a cylindrical shape and insert into the Feeding Chute.

4. Apples

Always use crisp varieties of apples for juicing such as Fuji Apples or Granny Smith. Avoid softer varieties of apples like Red Delicious, or any other apple that has a powdery consistency when biting into it.

HELPFUL HINTS

CLEAN UP

Keeping your juicer clean is extremely important for both your health and the peak performance of the machine. We recommend cleaning the juicer immediately after each use, before food particles have a chance to dry out. However, if you want to juice throughout the day in multiple sessions without disassembling the machine, completely remove the Outlet Adjusting Knob, place a large bowl under both the Juice Outlet and the Pulp Discharge Outlet, and pour about 16 ounces of water through the feeding chute while the machine is running, before and after each juicing session. Make sure to thoroughly clean the juicer after the last juicing session of the day.

1. Stains and Mineral Deposits

Colored stains and mineral deposits on parts are normal usage signs of a product. But, to remove color stains and mineral deposits:

1) Stains

- NEVER use harsh chemicals such as bleach to remove food stains from the juicer.
- Use a 25%-50% white vinegar/water solution and soak the parts overnight. This may be repeated if necessary.
- Juicing green honeydew or cantaloupe melons may also lighten stains.

2) Mineral Deposits

- Soak in a Baking soda solution
 1. Mix 4 tablespoons of baking Soda with 2 cups (16 oz) of lukewarm water
 2. Soak the parts in the solution of water and baking soda overnight to loosen the mineral deposits and to remove stains. Wash with soap and water and use a hard bristled brush to remove mineral deposit. Wipe with cloth to dry.
- Mineral Deposits may be removed from the tips of the Twin Gears by running soaked almonds through the machine.
- Another excellent way to remove mineral scales is to soak the affected parts in a pure vinegar bath overnight. This loosens the scaling and much of it can be brushed off. Repeat as necessary.

2. The Screen

- Hold the screen under running water while brushing the pulp residue from inside the screen first, and then the outside of the screen.
- For pulp that has been imbedded firmly in the holes of the screen, try soaking the screen for a couple of hours in water after brushing away as much pulp as possible.
- You may also try using the DULL side of a table knife to rub along the inner surface of the screen and then brushing from the outside with the Cleaning Brush.

3. The Main Body (Motor Unit)

To clean the motor unit of your juicer, position the front two legs over the edge of the sink. With either the sink top sprayer, a spray bottle filled with water, or an empty detergent bottle filled with water and equipped with its squirt-top, spray water directly onto the front plate of the juicer where the drive shaft, mounting peg and free wheel gear seats to remove pulp residue. Wipe any other exterior surfaces with a damp cloth. DO NOT SUBMERGE THE MOTOR UNIT INTO WATER AT ANY TIME.

4. Other Helpful Hints

- Use the narrow, pointed end of the cleaning brush to push food through out through the pulp discharge outlet.
- Dried fruits and nuts can be very sticky on the inside surfaces of the juicer. To remove the residue more easily run a couple of stalks of celery through before disassembling the machine.
- To help the Twin Gears retain their shine, alternate between running one tablespoon of carrot pulp and one teaspoon of granulated white sugar through the machine several times.

RECIPE INDEX

JUICE AND DRINKS

Citrus Blend -----	23
Apple Lemonade -----	23
Wheatgrass Delight -----	23
Ambrosia Nectar -----	24
Watermelon Quench -----	24
Mellow Melon Punch -----	25
Snappy Apple -----	25
Dr. Wallker's Choice(#61) -----	25
Green Tang -----	26
Oriental Express -----	26

RYE BREAD STICKS AND MOCHI(RICE CAKE) -----	27
--	-----------

PASTA AND NOODLES -----	28
--------------------------------	-----------

PÂTÉ AND CROQUETTE

Cashew, Curry Croquettes -----	29
Pecan Pleasers -----	29

SOUP

Beef Borscht -----	30
--------------------	----

DESSERTS

Cashew Poppy -----	31
Banana-Blueberry Ice Cream Pie (uncooked) -----	31

JUICES AND DRINKS

MACHINE SETUP FOR ALL JUICES AND DRINK RECIPES:

1. Place the **Twin Gears** in position
2. Use the **Fine Screen**
3. Tighten the **Latching Arm Knobs** snugly.
4. Tighten the **Outlet Adjusting Knob** completely.
5. Put glass Juice Pitcher under the **Juice Outlet**.
6. Put container under the **Pulp Outlet** to catch pulp.

Notice: When juicing a combination of hard, fibrous vegetables such as carrots or beets, with leafy greens, such as herbs or grasses, be sure to push any remaining bits of the hard vegetables completely through the Feeding Chute before introducing any of the leafy greens.

Citrus Blend

- 2 SMALL GRAPEFRUIT (peeled and cut into 4 to 6 pieces)
- 3 MEDIUM SIZE ORANGES (peeled and cut into 4 pieces)
- ½ SMALL LEMON (peeled and cut into 2 pieces)
- ½ SMALL LIME (peeled and cut into 2 pieces)

Note : for sweeter taste - use less lemon and lime

Apple Lemonade

- 3 FIRM APPLES (FUJI, PIPPIN, OR GRANNY SMITH, cut into 6 pieces)
- 3 MEDIUM SIZE ORANGES (peeled and cut into 4 pieces)
- ½ LEMON (peel is optional for sweeter flavor)

Wheatgrass Delight

- 4 HANDFULS WHEAT GRASS
- 4 CARROTS (cut in 2 to 4 pieces)
- 1 FIRM APPLE (cut into 6 pieces)
- 1 THIN SLICE GINGER

Ambrosia Nectar

2	BUNCHES	GRAPES
3		APPLES (FUJI, GRANNY SMITH, OR PIPPIN - cut into 6 pieces)
1		KIWI (peeled and cut into 2 pieces)
1	SLICE	HONEYDEW (cut into cubes)
1	SLICE	PINEAPPLE (cut into cubes)
1	WHOLE	LEMON (peeled and cut into 4 pieces)
½	CUP	CRANBERRIES

1. Alternate juicing grapes, kiwi pieces, melon cubes, pineapple cubes, apple pieces and cranberries
2. Juice lemon separately and add to taste

Note: Quantities of ingredients may be varied with good results. Do not be afraid to experiment according to your own taste.

Watermelon Quench

Watermelon with seeds - If organically grown, add rind also

Mellow Melon Punch

¼		CANTALOUPE (cut into cubes)
¼		HONEY DEW (cut into cubes)
2	SLICES	WATERMELON (cut into cubes)

Juice all together and enjoy

Snappy Apple

7	APPLES (FUJI, GRANNY SMITH, YELLOW DELICIOUS - cut into 4 to 6 pieces)
½	JALAPEÑO
¼	LIME
1	KIWI (peeled and cut into 2 pieces)

1. Juice Kiwi and Lime first
2. Next juice Jalapeño
3. Finish by juicing the Apples

Dr. Walker's Choice (#61)

10 oz.	CARROTS (cut into 4 pieces)
6 oz.	FRESH SPINACH

1. Juice Spinach
2. Juice Carrots

Green Tang

2		PINEAPPLE WEDGES (cut into smaller pieces)
1	SPRIG	MINT
3	HANDFULS	WHEATGRASS
¼		LEMON
1	SLICE	GINGER FOR FLAVOR

1. Juice wheatgrass
2. Juice mint
3. Juice lemon
4. Juice pineapple cubes

Note: A Pineapple wedge is a 1" round slice of whole pineapple cut into quarters (4 pieces). If pineapple is not organically grown, remove the outer skin before juicing.

Oriental Express

3	LEAVES	NAPA CABBAGE (cut lengthwise)
4	STALKS	BOK CHOY WITH LEAVES (cut lengthwise)
2	STALKS	ANISE (FENNEL) with GREEN STEM and LEAVES
6		MEDIUM CARROTS (cut into 4 pieces)
2		APPLES (YELLOW DELICIOUS, FUJI, OR GRANNY SMITH - cut into 4 to 6 pieces)

1. Juice Napa, Bok Choy and fennel first
2. Juice Apples second
3. Juice Carrots into the rest of the juice

BREADSTICKS AND MOCHI (RICE CAKE)

MACHINE SETUP:

1. Place the **Twin Gears** in position
2. Use the **Rice Cake Blank** (Closed Blank) instead of Screens
3. Put the **Pulp Discharge Casing** into position
4. Tighten the **Latching Arm Knobs** snugly
5. Remove the **Outlet Adjusting Knob** from the **Pulp Discharge Outlet** and replace it with the **Rice Cake Guide**
6. Put a plate under the **Rice Cake Guide**

Rye Breadsticks

2	CUPS	RYE (soaked overnight)
½	CUP	SUNFLOWER SEEDS (soaked overnight)
2	TBSP	CARAWAY SEED
½	TSP	SEA SALT

1. Mix all ingredients together in a bowl
2. Feed into machine a little at a time
3. Collect bread sticks as they emerge from the **Pulp Outlet** formed into bread sticks by **Rice Cake Guide**
4. Before drying, these sticks can be shaped into pretzels, braided together, etc. for a variety of shapes
5. Dry in the dehydrator until crisp. Can be served with dips, soups, etc.

Mochi (Japanese Rice Cake)

2	CUPS	STEAMED RICE (medium-grain rice recommended)
1	TSP	EXTRA VIRGIN OLIVE OIL

1. Prepare steamed rice
2. Add olive oil into the **Feeding Chute** while running the machine
3. Slowly feed steamed rice into **Feeding Chute**
4. The rice cake will come out of the **Rice Cake Guide**

Note: Before processing, mix spices such as minced garlic or onion with the rice to flavor your rice cake. Slice the rice cake into diagonal slices. Dehydrate them and add to your soup.

PASTA AND NOODLES

MACHINE SETUP:

1. Attach the **Twin Gear Housing** to the main body
2. Insert the **Pasta Screw** onto the motor drive shaft (left side as you are looking into the body)
3. Place the **Pasta Guide** over the **Pasta Screw**, making sure the long side of the **Pasta Guide** is on the left
4. Select the pasta shape desired from the two shapes available on the **Pasta Screen** and fit it onto the **Twin Gear Housing**. (See diagram on page 16)
5. Tighten the **Latching Arm Knobs** snugly
6. Place a plate under **Pasta Screen**

Pasta

1	PACKAGE	READY MIX PASTA DOUGH
1	TSP	EXTRA VIRGIN OLIVE OIL

1. Prepare pasta dough according to the instructions on the package of the pasta dough mix
2. Put a few drops of olive oil into the Feeding Chute while running the machine
3. Feed your pasta dough into Feeding Chute
4. Collect your pasta onto a plate

Variations:

If you use carrot juice when preparing the dough you will get red pasta. Use kale juice for green pasta and water for plain pasta.

Note: A whistling sound may occur initially, but will disappear after some dough has been fed through the machine.

PATÉ AND CROQUETTES

MACHINE SETUP:

1. Place the **Twin Gears** in position
2. Instead of the Juicing Screen, use the **Homogenizing Blank**
3. Tighten the **Latching Arm Knobs** snugly
4. Tighten the **Outlet Adjusting Knob**
5. Place a bowl under the **Juice Outlet**

Cashew-Curry Croquettes

2	CUPS	CASHEWS
1	CUP	SPROUTED WHEAT (soak for 12 hours and let small tips emerge by sprouting)
3	TBSP	CURRY PASTE (available from gourmet food stores)
1	TSP	VEGE-SALT TO TASTE

1. Put the cashews and sprouted wheat berries into the **Feeding Chute**.
2. Add curry paste and vege-salt a little at a time while texturizing
3. Collect the texturized mixtures from the **Juice Outlet**
4. Mix together by hand or with a wooden spoon
5. Form into croquettes and garnish with tomatoes, radish and cucumber

HINT: For a smoother consistency, use the Bread Stick Blank instead of the Homogenizing Blank, and remove the outlet adjusting knob. Collect the mixture from the pulp discharge outlet.

Pecan Pleasers

2	CUPS	PECANS
1	CUP	SPROUTED WHEAT BERRIES (soak 24 hours)
¼	CUP	SPANISH ONION
1	TSP	POULTRY SEASONING
½	TSP	VEGE-SALT

1. Put pecans, wheat berries, and onion into the Feeding Chute
2. Collect mixture in a bowl
3. Add the poultry seasoning and vege-salt
4. Mix thoroughly by hand or with a wooden spoon
5. Shape into small wafers and serve on cucumber slices with tomato or avocado on top

MACHINE SETUP:

A. To Juice Carrots, Lemon, And Apple

1. Place the **Twin Gears** into position
2. Use the **Fine Screen**
3. Tighten the **Latching Arm Knobs** snugly

B. To Grind Beets And Scallions

1. Place the **Twin Gears** into position
2. Use the **Homogenizing Blank**
3. Tighten the **Latching Arm Knobs** snugly

Beet Borscht

JUICE- A	1	APPLE (cut into 4 to 6 pieces)
	8	CARROTS (cut into 4 lengthwise pieces if the carrot is thick)
	½	LEMON (cut into 2 pieces)
GRIND - B	2	BEETS
	2	GREEN SCALLIONS
	1 CUP	FINELY SHREDDED CABBAGE
	1 DOLLOP	AVOCADO-YOGURT

1. Juice carrots, lemon, and apple. Keep juice in a glass or the **Juice Pitcher**
2. Remove the **Fine Screen** and replace with the **Homogenizing Blank** to grind beets and scallions into a separate bowl
3. Add ground beets and scallions to the carrot, lemon and apple juice and mix
4. Fold in the finely grated cabbage
5. In a blender- blend avocado and yogurt together

To serve: Place borscht in a bowl. Top with a dollop of avocado-yogurt.

MACHINE SETUP:

1. Place the **Twin Gears** in position
2. Use the **Homogenizing Blank**
3. Put the **Pulp Discharge Casing** into position
4. Tighten the **Latching Arm Knobs** snugly
5. Tighten the **Outlet Adjusting Knob**
6. Place a bowl under the **Juice Outlet**

Cashew Poppy

1	CUP	SPROUTED WHEAT BERRIES (soak for 12 hours until small sprout tips emerge)
1/4	CUP	POPPY SEEDS
1/4	CUP	SOAKED SUNFLOWER SEEDS
1	CUP	CASHEWS
1/2	TSP	VANILLA
4	TBSP	HONEY

1. Mix wheat berries (soaked), sunflower seeds (soaked), cashew and poppy seeds together then grind through the machine
2. Collect the ground mixture from the **Juice Outlet** into a bowl
3. Add vanilla and honey and mix
4. Roll into balls and place on a plate

Uncooked Banana- Blueberry Ice Cream Pie

1	CUP	SOAKED ALMONDS
1/2	CUP	SESAME SEEDS
1	CUP	CASHEWS
1/2	CUP	RAISINS
1/2	CUP	PITTED DATES
1/2	CUP	PECANS
1	TSP	VANILLA
2	TBSP	HONEY
7		FROZEN BANANAS (peeled)
1 1/2	CUPS	FROZEN BLUE BERRIES
1		KIWI (sliced)
2		LARGE STRAWBERRIES (sliced)

1. Grind almonds, cashews, sesame, pecans, dates and raisins together.
2. Mix in the vanilla and honey; knead to form dough: then press into a 9" pie dish to form a crust. Let crust sit for 3 to 4 hours or place in a food dehydrator for about 3/4 hour.
3. Grind frozen bananas and frozen blueberries together to make ice cream.
4. Put ice cream into the crust, top with slices of strawberries and kiwi. Slice and serve.

PRODUCT STANDARD

ITEM	VEGETABLE JUICER
MODEL	GREEN STAR®
ELECTRICITY RATING	USA Models : 120Vac, 60Hz, 180W
	EUROPE/ASIA : 220~240Vac, 50/60Hz, 120~140W
SIZE	476mm x 165mm x 306mm
WEIGHT	8.7kg

V0711GS

Updated in July 2011..

This version supersedes all former manuals issued before this date.