

WOSPORTS

G500 PRO WIFI Trail Camera

- Thanks for purchasing this trail camera
Please read before using this equipment
- If you have any questions or problems.
Please contact us by email: support@wosports.com

CONTENTS

PART LIST	4
PRODUCT STRUCTURE	
Front View	5
Operation Interface	6
Bottom View	7
Back View	7
CAMERA OPERATIONS	8
How to use?	8
LOADING BATTERIES	9
INSERTING SD CARD	10
HOW TU INSTALL APP	11
STEPS/INSTRUCTIONS FOR CONNECTING TO WIFI	12-16
USING THE CAMERA	17
Operating Buttons	17
ITEM SETTINGS	18
Settings Menu	18
Quick Setting	18-22
MOUNTING	23
TECHNICAL SPECIFICATION	24-25
FAQ	26-31

PARTS LIST

- 1.Trail Camerax1
- 2.User's Manualx1
- 3.Nylon Strap with Bucklex1

- 4.Wall Mountx1
- 5.Screwsx3

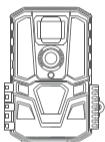

①



②



③

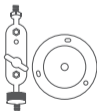

④



⑤

PRODUCT STRUCTURE

FRONT VIEW

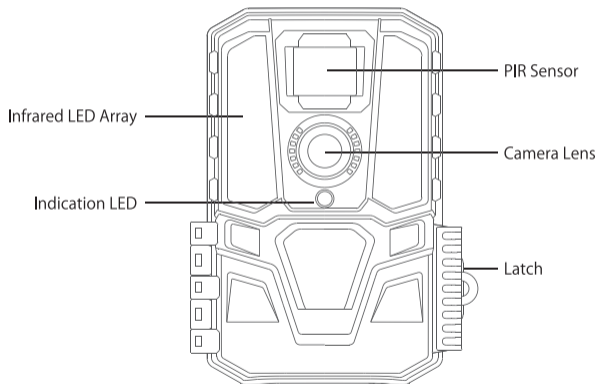

PRODUCT STRUCTURE

OPERATION INTERFACE

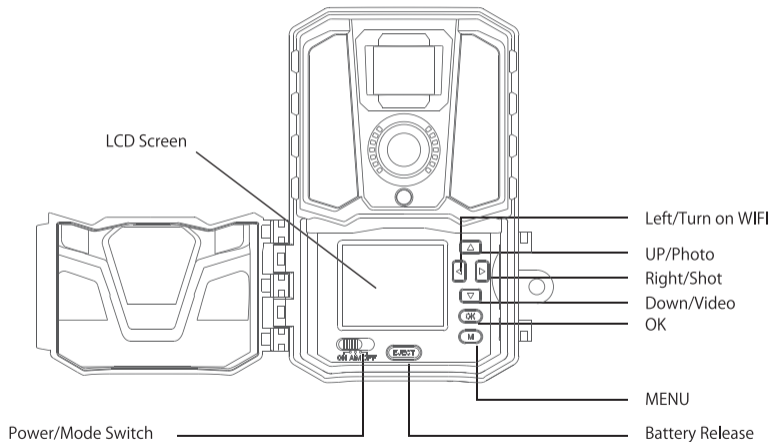

PRODUCT STRUCTURE

BOTTOM VIEW

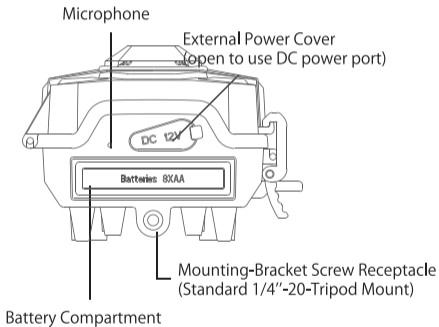

BACK VIEW

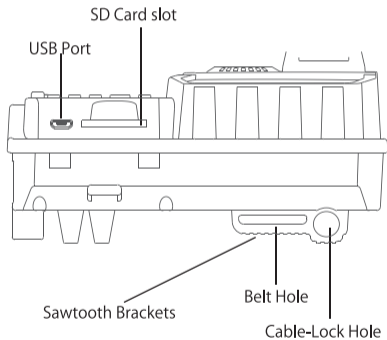

CAMERA OPERATIONS

HOW TO USE?

1. Install 8pcs AA batteries (NOT INCLUDED).
2. Install SD card (CLASS 6 or higher class Up to 32GB max, NOT INCLUDED).
3. Put the switch to "AIM", then you can setting (Date/Time, Image resolution, video resolution, and the Interval time etc)
4. Put the switch to the "ON" position, it will enter the PIR detection state. Then the trail camera starts working.

Note:

1. Be sure to switch the camera's power OFF before inserting /exiting the SD card and loading/unloading the batteries.
2. Formatting the SD card before using it for the first time is recommended. (Put the switch to "AIM " .Press " Menu " - "Settings" - "Format" - Press OK to format the SD card .)
3. A full set of 8AA Alkaline or Lithium batteries is recommended

LOADING BATTERIES

1. Press the Battery Tray EJECT button to release the battery tray and pull it out for loading. Switch the camera's power OFF when loading/unloading batteries.
2. Be sure to inset each battery so its polarity(+/- direction) matches the polarity indications at the bottom of the battery tray. A full set of 8AA Alkaline or Lithium batteries should be used .
3. Pull the battery tray into the host, you will hear a slight "click" sound, which means the battery compartment is locked.

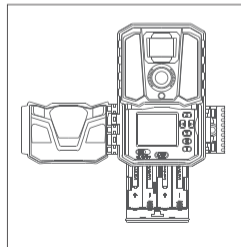
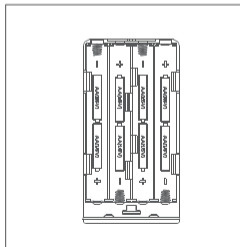
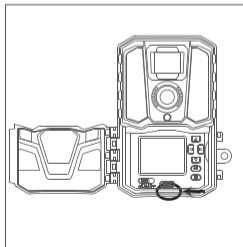

INSERTING SD CARD

Make sure that the SD card is insert correctly .If you hear“click” sounds that means it has be inserted correctly .The camera uses a standard SD memory card to save your photos or videos.SD and SDHC (high capacity)class 4 or higher seed cards up to a maximum 32GB are supported. A class 10 memory card is recommended when the camera works at burst mode.

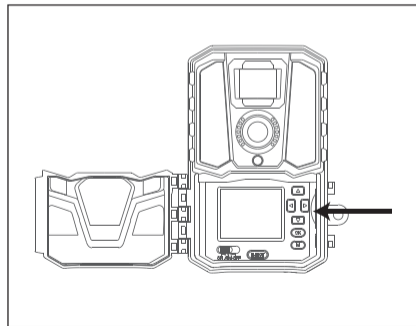
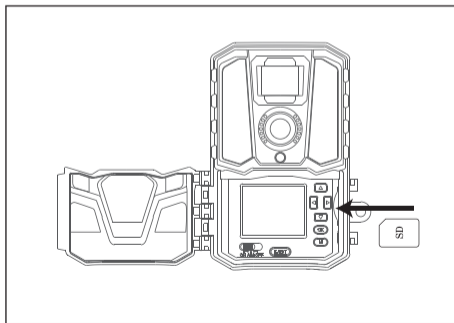

HOW TO INSTALL APP

Please install the APP on your smart phone before using. Search the keyword "Remote Trail CAM" to download and install at Apple Store and Google Store, or scan the QR code as below:



IOS



Android

STEPS/INSTRUCTIONS FOR CONNECTING TO WIFI:

1. Turn on Wifi

In AIM mode, you can press left button to open wifi and press OK button to exit wifi;





In ON mode, turn on WIFI via Bluetooth, open APP, click "connect camera", and the Bluetooth list appears to find the corresponding device (device...), click on open WiFi;

2. Connect WiFi

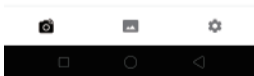
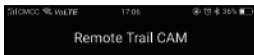
Turn on WIFI via bluetooth, then switches to the WiFi hotspot list automatically, connect the device of "G500-WIFI-...", the default password is "12345678". If WiFi is enabled via the left button, click the "Connect camera" button and click the second step to connect WiFi directly.

3. Main Interface









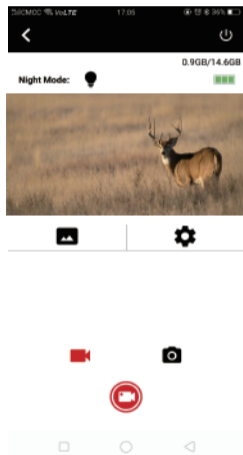

 Connect Camera	Turn on wifi or goes into the preview mode.
	connect to the camera interface
	View pictures or videos that have been downloaded to your phone
	APP version

4. Goes into the preview mode

Connect the WIFI hotspot, then click on "connect camera", can goes into the preview mode, the interface as below:



	Turn off Wifi
	The camera's battery indicator
0.3GB/14.6GB	The camera's capacity indicator
	Turn on or turn off the IR LED
	The camera playback
	Camera Setting
	Turn on video mode
	Turn on photo mode
	Video recording or photo taking

5. Click the playback icon to download photos/videos, interface as below :

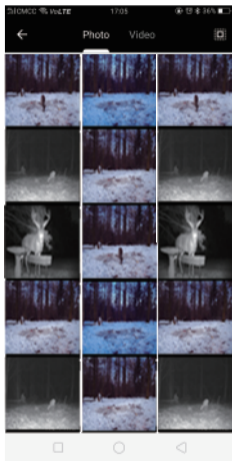





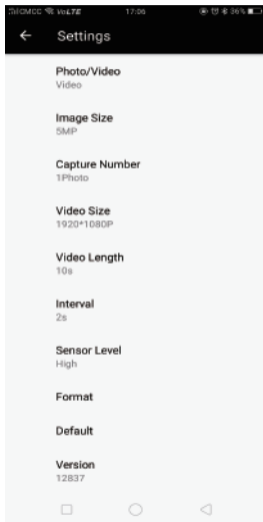



Click "  ", then select pictures to download or delete.

6. Click the camera Settings icon to turn on the camera Settings, interface as below:



USING THE CAMERA

Operating Buttons

1.  :Page up.
2.  :Page down.
3.  :Page left.
4.  :Page right/ Shot key
5.  : Save settings.
 : Review photos and videos in the AIM mode.
Press OK again to exit the preview interface.
6.  : Enter the setup menu in preview mode.
 :Exchange between main screen and setup.
- 7.AIM mode: To program camera.
- 8.OFF mode: To turn off the camera.
- 9.ON mode: When movement occurs in the monitoring region, the camera will take pictures or videos automatically according to the previous programmed setting. After switching the camera to ON position, the motion-indication LED (red) will blink for about 10 seconds. This interval allows time for you to close the Cam's front cover, lock it, and leave the monitored area.

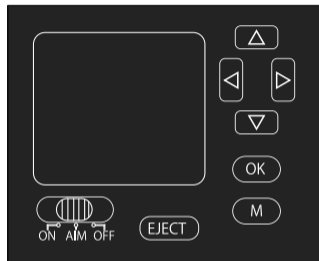

ITEM SETTINGS

Settings Menu

To view the camera settings menu, press(M) in the AIM mode.

Use ▲ or ▼ to select the sub-menu, use ◀ or ▶ to select the different options, then press (OK) to save the setting and the option. Press(M)to return.

Quick Setting

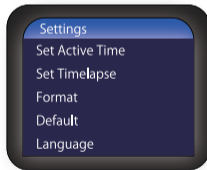
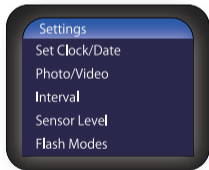

Setting Items	Sub menu	Description
Set Clock/ Date	00:00 00-00-0000	-Hour: Minute -Month-Date-Year

Setting Items	Sub menu	Description
Photo/Video		There are 3 modes to choose from Photo Video, Photo& video
Photo	Image Size Capture Number	-5MP, 16MP , 30MP Image size can be selected. -Number of photos per PIR capture. Can select 1-6 images.
Video	Video Size Video Length	-Quality: HD:1280 x720P video ,FHD:1920x1080P,QHD: 2560x1440P,and VGA :640x480P video -Video Length: Select between 5,10,20, or 30 seconds. We recommends setting the video length for more shorter to maximize battery life.
Photo &Video	Image Size Capture Number Video Size Video Length	-If you choose this mode, the camera will take a photo first ,then start to record video.

Setting Items	Sub menu	Description
Interval	2second -60second 5minute-60minute	This interval means how long the PIR will be disabled after each triggering in the ON mode. During this time, the PIR will not react motion. The minimum interval is 2 seconds and the maximum is 60 minutes.
Sensor Level	LOW Middle High	-Set the sensitivity of the sensor. -Low sensitivity, Middle sensitivity, High sensitivity can be set .The higher degree indicates that the camera is more easily triggered by motion.It is recommended to use lower sensitivity for environments with lots of interference like wind, tall grass, or intense shadows.
Flash Modes	Power Save Long Range Fast Motion	-Set the distance of infrared induction. There are three options can be selected. - Power Save- Medium LED output Medium Shutter Speed. - Long Rang-High LED output Low Shutter Speed. - Fast Motion- High LED output Fast Shutter Speed.

Setting Items	Sub menu	Description
Set Active Time	Off ON Start 00:00 Stop 00:00	- Off means you shut down the function. - ON — The camera would always worked within the active time you set up.
Set Time lapse	Off ON TL Freq TL period	- Off — Close the time lapse function -Time lapse delay: Can select 5, 10 ,15, 30, 60 minutes. For example, set the interval to 5 minutes, the camera will take a photo each 5 minutes. The camera will take photos automatically during the 2 blocks of time you set up at "A" and "B". Note: If the time of period A and period B you set are not within "Active Time" you set, the time lapse function will not react during this time quantum.
Format	Yes/No	- If you choose format SD card, the system will delete all images and video stored on the SD card. Make sure that you have a backup of important data. (Highly recommended to format with new SD cards.)

Setting Items	Sub menu	Description
Default	Yes/No	-Returns to default settings. Default settings are as follows:English, Photo,5MP,1Pict, Serial number and so on.
Language	English 日本語 Deutsche	-English , Japanese, Deutsche can be selected as camera language.
Camera Name	<input type="checkbox"/> <input type="checkbox"/> <input type="checkbox"/> <input type="checkbox"/> <input type="checkbox"/> <input type="checkbox"/> <input type="checkbox"/> <input type="checkbox"/> <input type="checkbox"/> <input type="checkbox"/> <input type="checkbox"/> <input type="checkbox"/> <input type="checkbox"/> <input type="checkbox"/> <input type="checkbox"/> <input type="checkbox"/>	-Set this serial number to identify different shooting locations by numbering when multiple machines are in use at the same time. After setting, the serial number you set for the camera will stamp on the photos or videos.
Camera Name	G500-wifi-	Set wifi ID
Wifi Password	12345678	Set wifi password
Software Update	Update	-Press OK when Update is shown and the camera will read the software update files placed on the SD card if the Firmware version number needs to be updated to a more current version.
Version	BT1.0	Camera Version

MOUNTING

After the setting the camera's time/date and other options to your preference , you're ready to take it outside and begin capturing images of animals in the area you want to monitor.

When mounting the camera to a tree, use the adjustable web belt provided. Please be sure to mount it in place correctly and securely. To get the optimal picture quality, the tree should be about 10-30ft. away from the place to be monitored, with the camera placed at a height of 3.6-4.5ft..

Tips: Try not to mount the camera facing the rising or setting sun. If mounting to a feeder or in a dusty environment , be sure to clean the camera lens and the PIR sensor regularly.

Periodically check the mounting of the camera to make sure it hasn't come loose. Check the batteries frequently to ensure they are still providing power to the camera.

TECHNICAL SPECIFICATION

Resolution	5MP Native Sensor/Up to 30MP Interpolated
Trigger Speed	0.3s
Camera Lens(FOV)	120 degree
IR Illumination	40pcs 850 LEDs
IR Flash Distance	90' Flash
Video Resolution	2560x1440P 1920x1080P 1280 x720P 640x480P
Detection Distance	Up To 80 ft
Recovery Rate	1s
Time Lapse Mode	Yes
Multi Shot Mode	Up to 6 Per Trigger

WIFI	IEEE802.11b/g/n
Bluetooth	5.0 BLE
Battery Life	Up to 18 month
LCD Screen	2.0" LCD Screen
Button Interface	Backlit 6 Button
Attachment Interface	1/4"-20 Brass Insert Bottom w/Dead Stop
Case Color	Camo Dipped Front Case
Power Source	8AA 12V
DC IN	12V DC In
Cable Lock Compatible	Yes, Closed Dual Slot Above Dual Strap Slot
Accessories	Nylon Strap with Buckle
Weight (Product without packaging)	Less Than 273.5 Grams (Without Batteries)
Dimensions (Product without packaging)	147mm x90mm x55mm

FAQ

CAMERA WON'T POWER UP

1. Make sure that you have installed all batteries in the battery compartment, filling all battery spaces with no "gaps".
2. We recommend using a full set of 8 Energizer® Lithium AA batteries.
3. Make sure that the batteries are installed correctly, observing proper polarity.
4. Please be sure to switch the power "OFF" and remove the batteries if necessary. Trying to reopen the camera after 1 min.

FAQ

CAMERA STOPS TAKING IMAGES OR WON'T TAKE IMAGES

1. Please make sure that the SD card is not full. If the card is full (display indicates "FULL", the camera will stop taking images.)
2. Make sure that the power/mode switch is in the ON position and not set to OFF or AIM.
3. Make sure that you are using a good quality SD card in your camera. We recommend SanDisk® SD cards up to 32GB.
4. If the SD card has its write protect switch in the lock position, the camera will not take images.
5. Formatting the SD card before using it for the first time is recommended. It can be completed using the "format" function. Make sure you have backed up (saved to your computer) any files you want to keep on a previously used card, as formatting erases all files.
6. Please make sure that the battery has enough power to support to work.

FAQ

BATTERY LIFE IS SHORTER THAN EXPECTED

1. Check to make sure you have used new alkaline or lithium batteries. We recommend using a full set of 8 Energize® Lithium AA batteries to obtain maximum battery life.
2. These are several variables that will determine the battery life including type of batteries, temperature outside, recording settings, frequency of camera activity, etc. Colder temperatures, night photos and photo frequency (low camera delay) will result in shorter battery life. Note: capturing video clips and time lapse uses more power and will result in shorter battery life than capture motion detected photos. 2S Interval mode will use more power as more photos and videos will be taken. We recommend setting the Interval time for more longer time to maximize battery life.
3. Make sure that you are using a good quality SD card in your camera. We recommend SanDisk® SD cards up to 32GB. Our experience indicates that poor quality SD cards can sometimes reduce your camera battery life.

FAQ

CAMERA PIR WON'T WORK

1. Check the Interval time you settings. It won't take images for a long time if you setting the Interval time is too longer .You can figure out that by restore the camera to factory settings.
2. Check if something stuff on the PIR sensor, please be sure the PIR sensor is clean.
3. Higher temperature will make the PIR detection distance become shorter. So that sometimes the animal will not be monitored even it is through by the PIR sensor's detection of activity in the area it covers.

Please be sure to mount the camera in place correctly and securely. The height is need to keep the same between the animal and camera.

CAMERA TAKES CONTINUOUS IMAGES OF NO SUBJECT

A camera has what is know as a "false trigger" if the PIR sensor thinks that there is motion and heat in front of the camera lens when there is no subject in the images. These "false triggers" are the result of placing the camera in an environment where there is motion associated with tree branches creating motion in front of the camera or an area where

FAQ

there is high heat in the foreground and any motion from wind cloud set off the camera.

Setting a camera up over water is also a potential cause for this issue. To remedy this situation.

1. Try moving the camera to an area that does not have any of these issues or remove potential obstacles near the lens if possible.

2. If the camera continues to take images when there is no subject in them, test the camera by placing it in an indoor environment and aiming at a location where there is no motion.

If the camera continues to show issues, then there is probably an electronic component issue. If this is the case, please contact service team.

PHOTO AND VIDEO QUALITY PROBLEMS

1. The image is blurred or out of focus

Check if something is on the lens, please be sure the lens is clean.

2. Daytime photos or videos appear too bright/dark

Make sure that the camera is not aimed at the sun or other light sources during the day.

FAQ

3.Night photos or video appear too bright

You will get the best results when the subject is within the ideal flash range, no closer than 3m from the camera. Subjects may appear too light at closer distances.



We will offer prompt and authoritative reply within 24 hours, and try our best to resolve your problem ASAP.

