

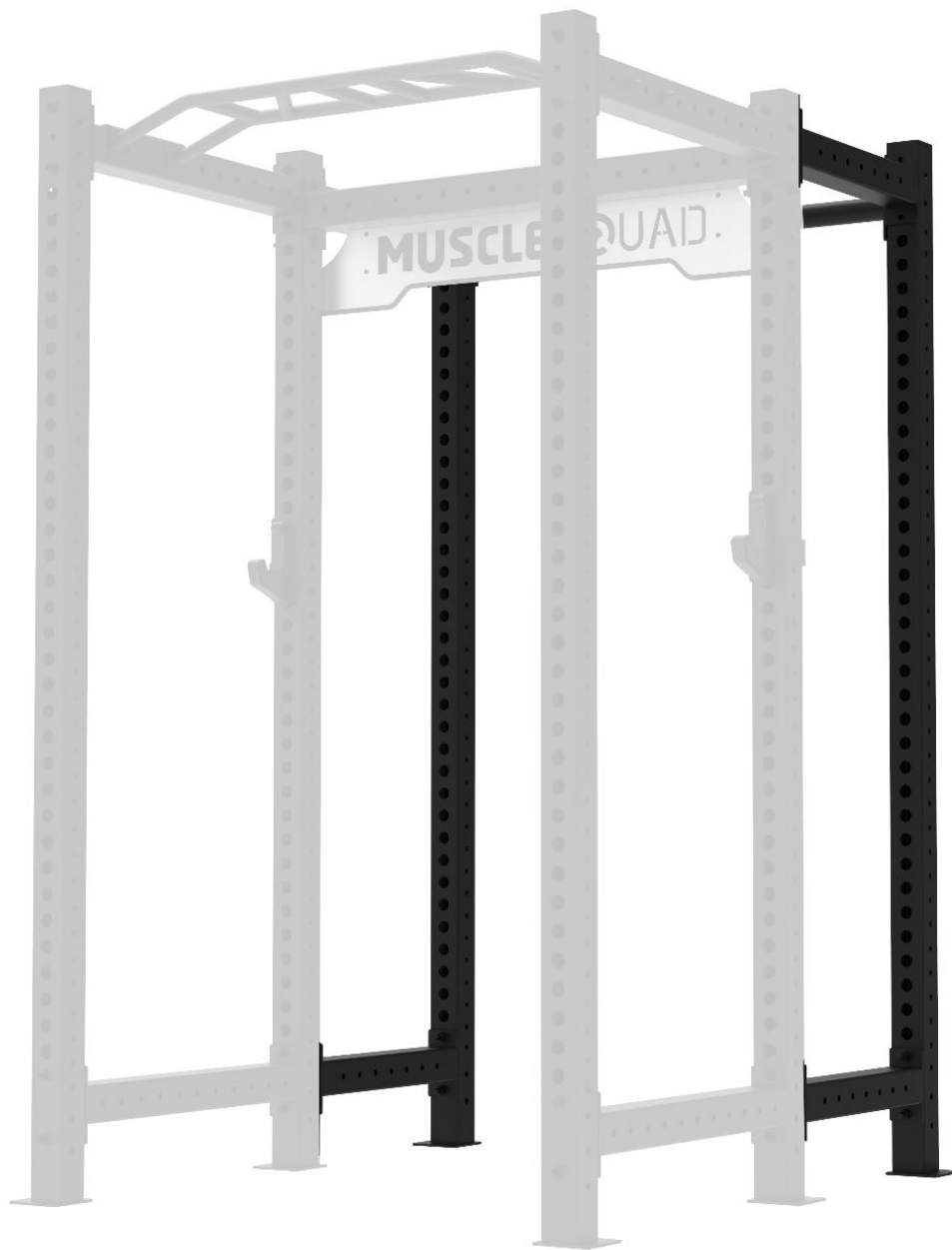

## MuscleSquad Phase 3 Power Rack to Full Power Rack Extension

### Assembly & User Manual



**Important** – Please read these instructions fully before assembly and use.

# Contents

**Safety Information**

**Opening the Carton**

**Hardware Pack**

**Assembly Instructions**

**Exploded Parts Diagram**

**Exploded Parts List**

**Exercise Information**

**Care & Maintenance**

**Guarantee**

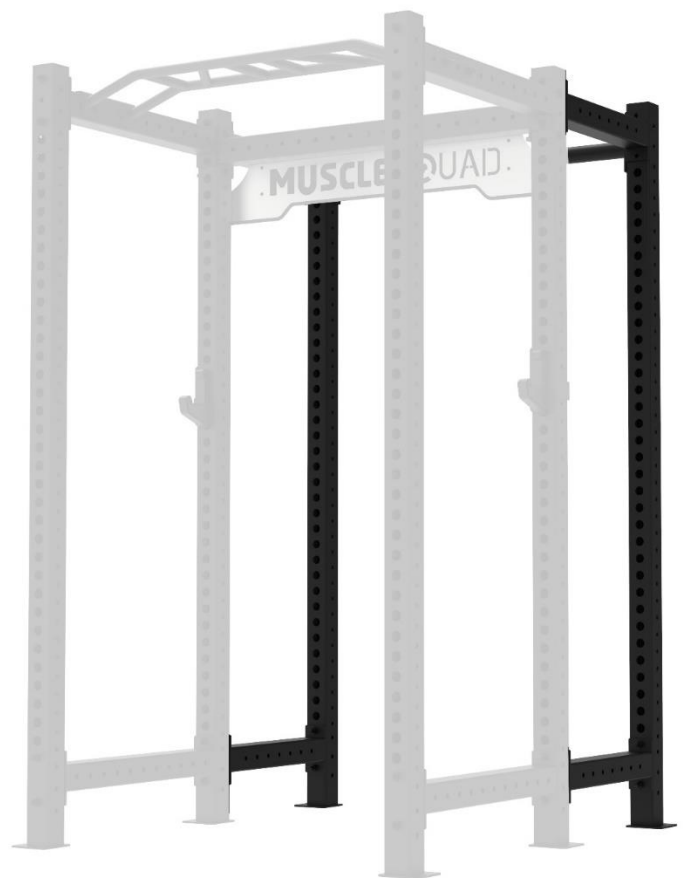

# Safety Information

## **Important – Please read fully before assembly or use**

This exercise equipment is built for optimum safety. However, certain precautions apply whenever you operate a piece of exercise equipment. Be sure to read the entire manual before you assemble, operate or use this equipment. Note the following safety precautions.

### **Assembly**

- Check you have all the components and tools
- Remove all fittings from the plastic bags and separate them into their groups.
- Keep children and animals away from the work area, small parts can cause choking if swallowed.
- Make sure you have enough space to layout the parts before starting.
- The assembly of this equipment is best carried out by 2 people.
- Assemble the item as close to its final position (in the same room) as possible.
- Position the equipment on a clear, level surface.
- Dispose of all packaging carefully and responsibly.

### **Using**

- Do not use the equipment near water or outdoors.
- Keep children and pets away from the equipment at all times. Do not leave children unattended in the same room with the equipment.
- Before using the equipment to exercise, always warm up with stretching exercise.
- This product is intended for domestic use only.
- If the user experiences dizziness, nausea, chest pain or any other abnormal symptoms STOP the workout at once.

### **CONSULT A DOCTOR IMMEDIATELY**

- Only one person at a time should use the equipment.
- Keep hands away from all moving parts.
- Always wear appropriate workout clothing when exercising. Do not wear loose flowing clothing that could become caught in the equipment. Running or aerobic shoes are also required when using the equipment.
- Use the equipment only for intended use, as described in this manual. Do not use attachments not recommended by the manufacturer.
- **Do not** place any sharp objects on or near the equipment.
- Disabled persons should not use the equipment without a qualified person or doctor in attendance.

- Never operate or use the equipment if it is damaged or not functioning properly.
- Examine the equipment frequently especially the easily damaged parts. The safety level of the equipment can only remain if it is examined regularly. Replace any defective components immediately. **Do not** use the equipment until it has been repaired.
- Parents and others responsible for children must be aware that playing on the equipment could be dangerous and lead to possible injury. Children must not be left unattended with the equipment.

### **Combined weight capacity of 316kg**

- Your product is intended for use in clean dry conditions. You should avoid storage in excessively cold or damp places as this may lead to corrosion and other related problems that are outside our control.
- This product conforms to:  
(BS EN ISO 20957) PARTS 1.2.4 class (H) - Home Use - Class (C).  
**This product is not suitable for therapeutic purposes.**
- This exercise product has been designed and manufactured to comply with the latest (BS EN ISO 20957) British and European Safety Standard

# Safety Information

The free area must be at least 0.6m greater than the training area. This is a space where you can safely dismount, without obstruction, in case of an emergency. Where two pieces of equipment are positioned adjacent to each other the free area may be shared.

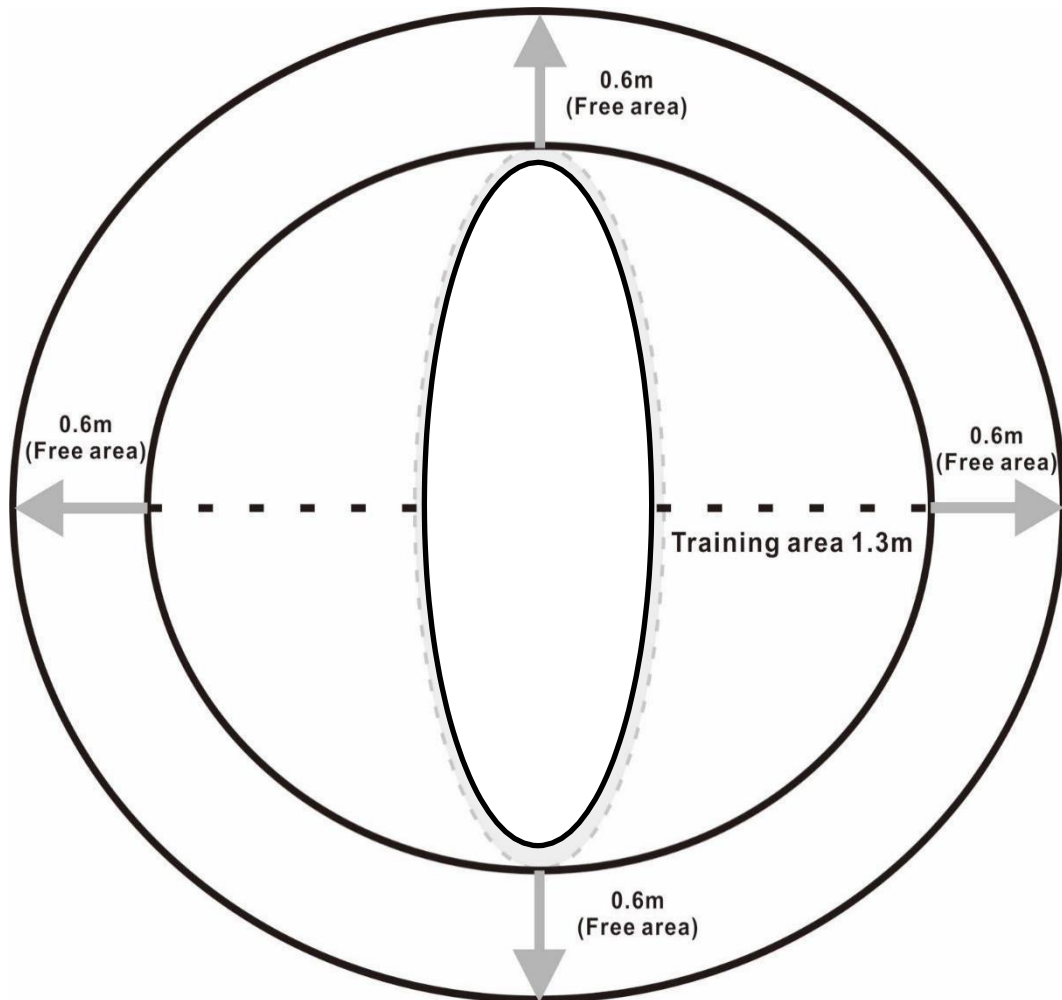

**Only one person should be within the training area when the equipment is in use.**

# Opening the Carton

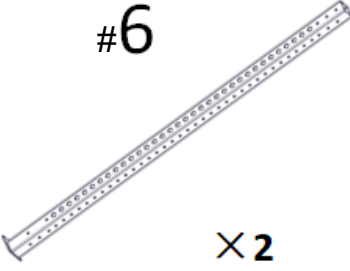
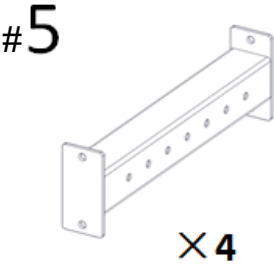
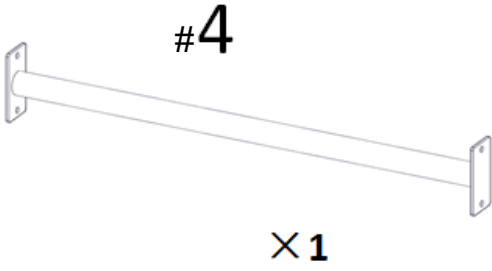

**HARDWARE PACK**  
× 1

# Hardware Pack



#1 M12 × 100mm Hex Bolt × 12



#3 M12 Aircraft Nut × 12



#2 Ø12mm Washer × 24



Wrench × 2

# Assembly Instructions

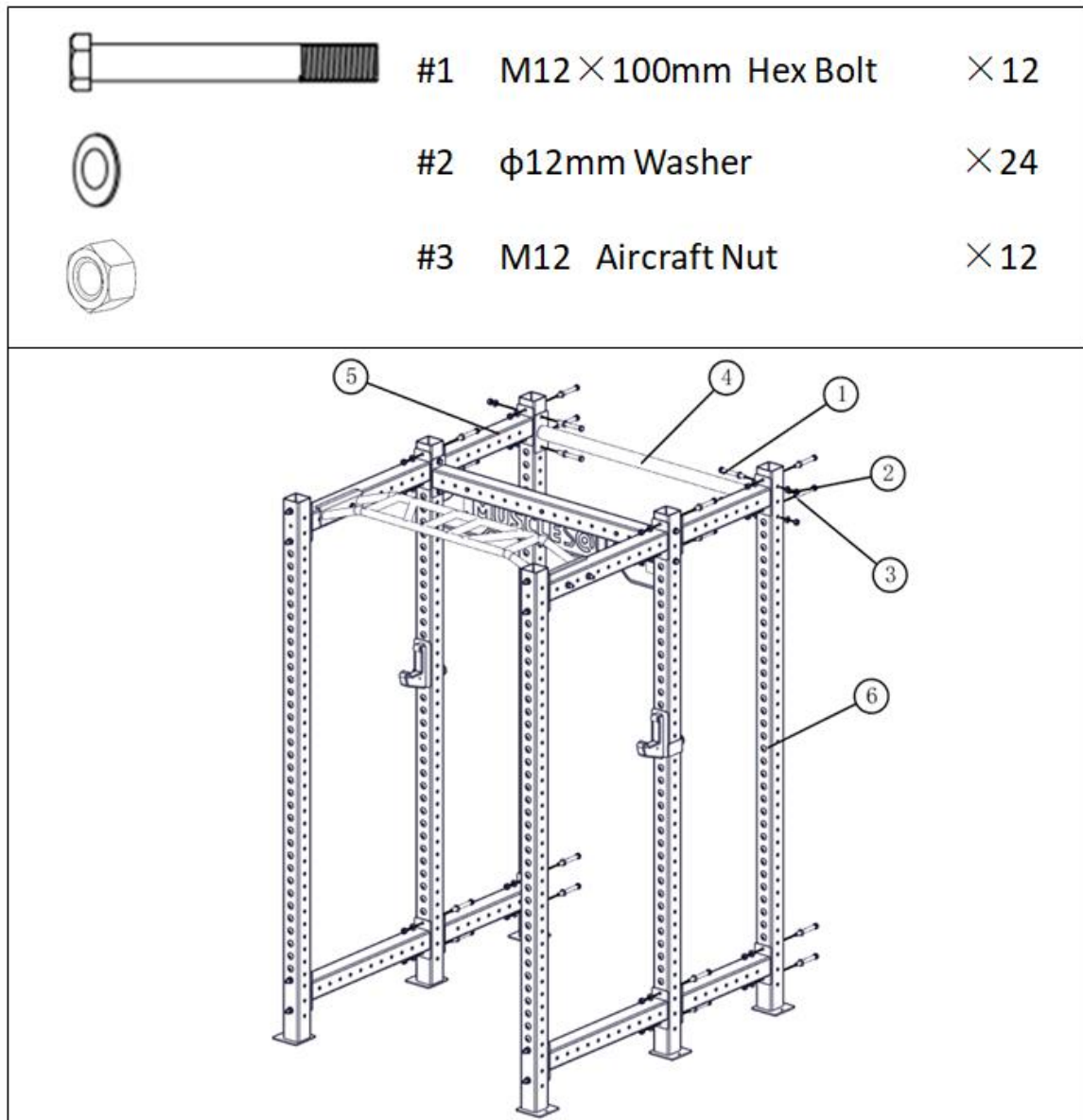

## Step 1

- Attach two Rear Vertical Supports (#6) with four Short Connect Bars (#5), Align upper and bottom holes and secure each of them with four M12x100mm Hex Bolts (#1), eight φ12mm Washers (#2) and four M12 Aircraft Nuts (#3).
- Place the Cross Beam (#4) to the center of the two Rear Vertical Supports (#6), Align upper holes and secure each side with two M12 x 100mm Hex Bolts (#1), four φ12mm Washers (#2) and two M12 Aircraft Nuts (#3).

# Parts List

Key No.	Description	QTY
1	M12x110mm Hex Bolt	12
2	Ø12mm Washer	24
3	M12 Aircraft Nut	12
4	Cross Beam	1
5	Short Connect Tube	4
6	Rear Vertical Support	2



# Exercise Information

Tailor your exercise program according to your physical condition. If you have been inactive for several years, or are overweight, you must start slowly and gradually increase your time on the equipment; a few minutes per workout increase is advisable.

Initially, you may be able to exercise only for a few minutes in your target zone; however, your aerobic fitness will improve over the next six to eight weeks. Do not be discouraged if it takes longer. It is important to work at your own pace.

## ***Please remember these essentials:***

- Have your doctor review your training and diet programme to advise you of a workout routine you should adopt.
- Begin your training programme slowly with realistic goals.
- Monitor your pulse frequently. Establish your target heart rate based on your age and condition.
- Set up your equipment on a flat even surface with an adequate training area, as prescribed in this manual.

## **Exercise intensity**

To maximize the benefits of exercising, it is important to exercise with proper intensity. The proper intensity level can be found by using your heart rate as a guide. For effective aerobic exercise, your heart rate should be maintained at a level between 65% and 85% of your maximum heart rate as you exercise. This is known as your target zone. You can find your target zone in the table below.

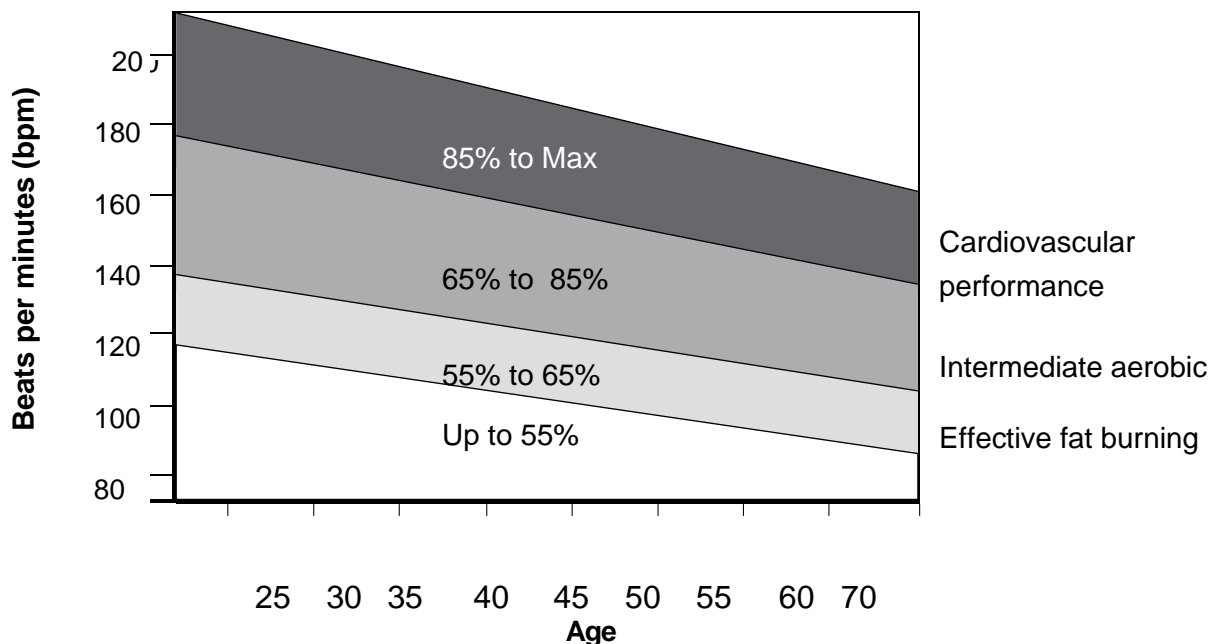

During the first few months of your exercise programme, keep your heart rate near to the low end of your target zone as you exercise. After a few months, your heart rate can be increased gradually until it is near the middle of your target zone as you exercise.

To measure your heart rate, stop exercising but continue moving your legs or walking around and place two fingers on your wrist. Take a six-second heartbeat count and multiply the results by 10 to find your heart rate. For example, if your six-second heartbeat count is 14, your heart rate is 140 beats per minute.

(A six-second count is used because your heart rate will drop rapidly when you stop exercising.) Adjust the intensity of your exercise until your heart rate is at the required level.

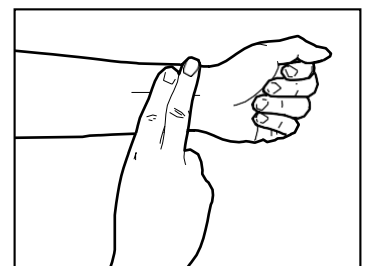

# Exercise Information

## Muscle Chart

### Aerobic Exercise

Aerobic exercise improves the fitness of your lungs and heart - your body's most important muscle. Aerobic exercise fitness is promoted by any activity that uses your large muscles (arms, legs or buttocks, for example).

### Weight Training

Along with aerobic exercising which helps get rid of and keep off the excess fat that our bodies can store, weight training is an essential part of the routine process. Weight training helps tone, build and strengthen muscle. If you are working above your target zone, you may want to do a lesser amount of reps.

### Targeted Muscle Groups

The exercise routine that is performed on the training bench will develop the core muscle groups. These muscle groups are highlighted on the muscle chart below.

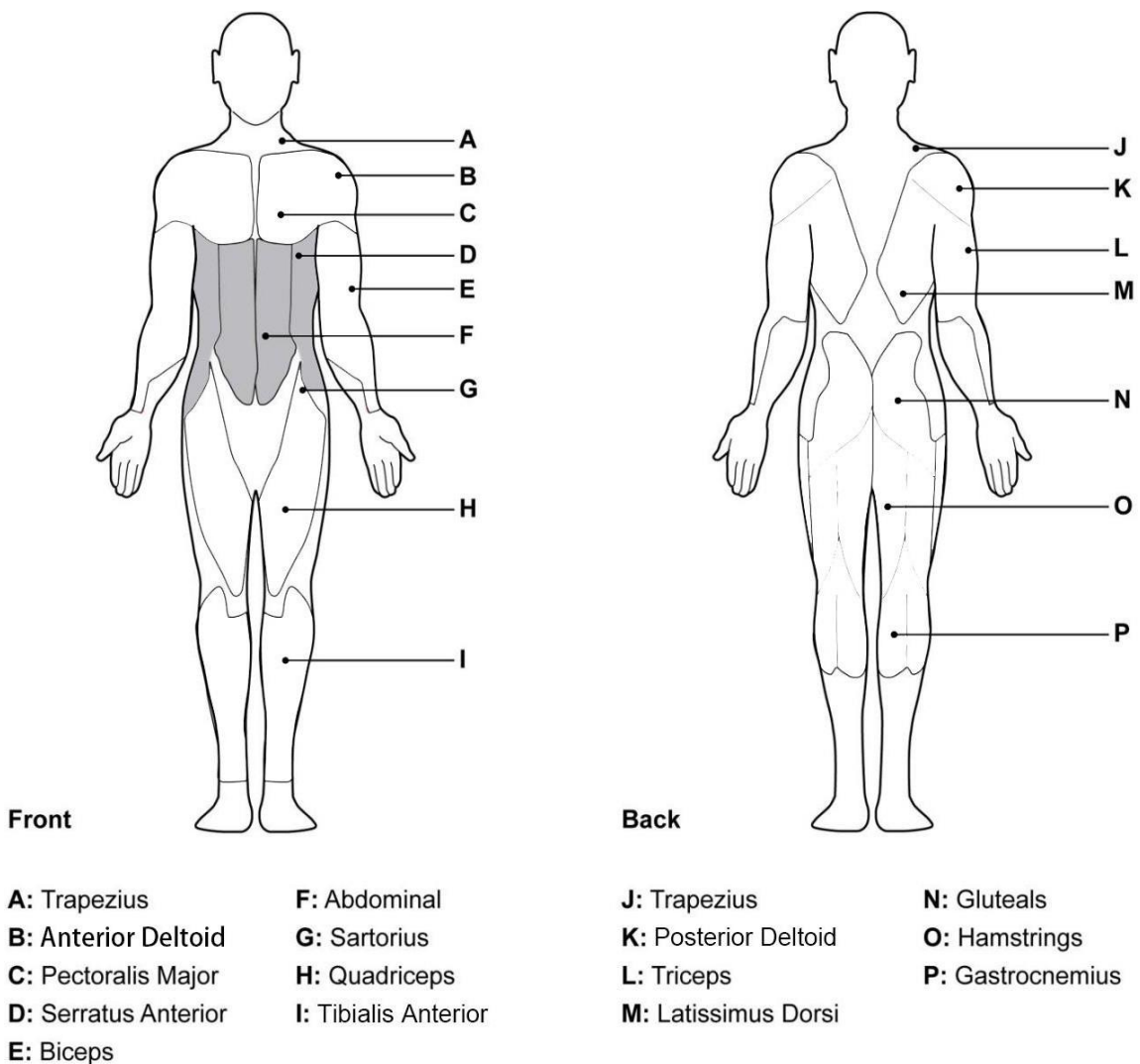

# Exercise Information

Each workout should include the following three parts:

1. A warm up, consisting of 5 to 10 minutes of stretching and light exercise. A proper warm up increases your body temperature, heart rate and circulation in preparation for exercise.
2. A training zone exercise consisting of 20 to 30 minutes of exercising with your heart rate in your training zone. (**Note:** During the first few weeks of your exercise programme, do not keep your heart rate in your training zone for longer than 20 minutes.)
3. A cool down, with 5 to 10 minutes of stretching. This will increase the flexibility of your muscles and will help to prevent post-exercise problems.

## Exercise Frequency

To maintain or improve your condition, plan three workouts each week with at least one day of rest between workouts. After a few months of regular exercise, you may complete up to five workouts each week, if desired. Remember, the key to success is to make exercise a regular and enjoyable part of your everyday life.

### Walkout T-Rotation

Feet shoulder width apart reach down to floor and walk hands away from feet into a plank position. Twist through torso to raise one hand up to ceiling and reach back to further stretch the pectoral region. Return to plank position and repeat on other side. Walk back up to standing and repeat for 12-15 repetitions. For a little extra, add a push up each time you are in the plank position.

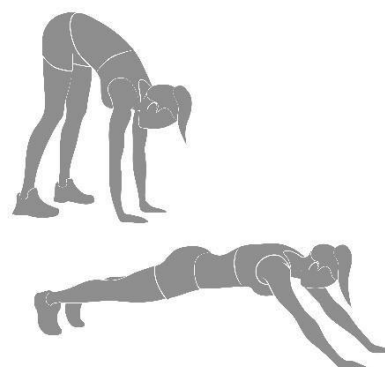

### Wall Slides

With back and heels against the wall, raise arms up over head and place back of hands and elbows against the wall. Keeping elbows and backs of hands against the wall draw elbows down and in towards ribcage, then return to overhead position. Repeat for 12-15 repetitions.

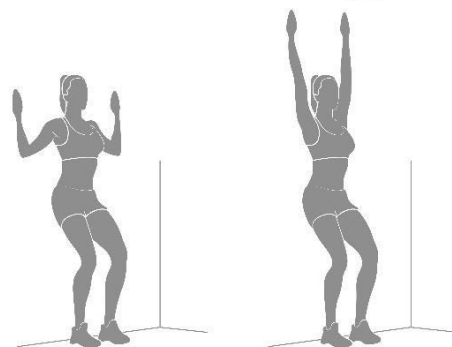

### Scorpions

Lying face down on the floor, take arms out to sides with palms down (creating T shape with body if looking from birdseye view). Bring opposite heel of foot up towards opposite extended hand rotating through torso and lifting chest. Ensure arm/shoulder of extended arm you are aiming for heel to touch stays pushed down into the ground to stretch through chest and front of shoulder. Repeat on other side. Repeat for 10- 12 repetitions each side.

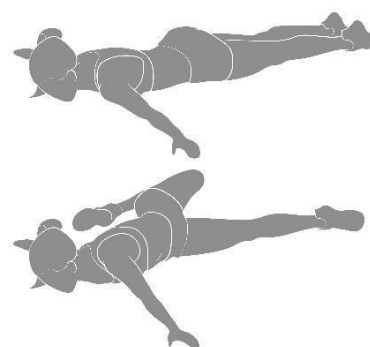

# Exercise Information

## Iron Crosses

Lying flat on back, take arms out to side with palms face up to create T shape with body if looking from above. Raise one leg and bring up and across body to touch down on opposite side floor (bend knee for less intense stretch and straighten to intensify). Ensure back and shoulders stay flat on floor.

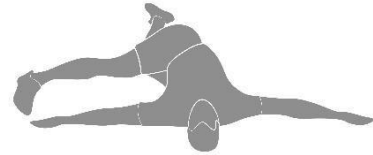
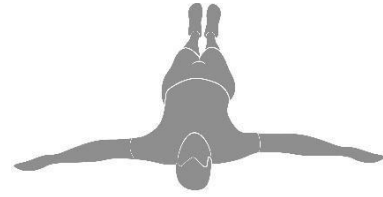

## Quadruped T-Spine Rotation

In kneeling position and sitting on heels place hands in front of knees. Take palm of one hand to back of head. Draw elbow of this arm down to opposite knee, then rotate elbow up as high as you can to ceiling by turning through torso. Other hand and knees must remain flat on floor.

Repeat for 12-15 repetitions each side.

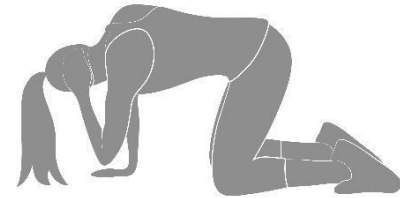

## Band Pull Aparts

Using a light resistance band, hold the band with hands just wider than shoulder width apart and at shoulder height. Keeping arms straight, pull arms apart from each other to stretch band across front of chest and pinch shoulder blades together. With control, and arms remaining straight, return to start position. Repeat for 12-15 repetitions. To make harder, hold band closer together. To make easier, hold band further apart.

**Resistance bands available at:**  
[www.musclesquad.com](http://www.musclesquad.com)

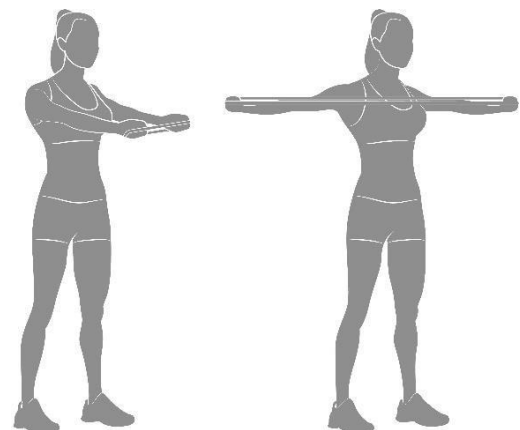

# Care & Maintenance

1. The safety level of the equipment can only be maintained if it is examined regularly for damage and wear e.g. the connection points.
2. Inspect and tighten all parts before using the equipment. Replace defective components immediately and/or keep the equipment out of use until repaired. Pay special attention to the components most susceptible to wear.
3. The equipment can be cleaned using a damp cloth and mild non-abrasive detergent. **Do not** use solvents.
4. **Do not** attempt to repair this equipment yourself. Should you have any difficulty with the assembly, operation, or use of your exercise product or if you think that you may have parts missing, contact the MuscleSquad on [info@musclesquad.com](mailto:info@musclesquad.com).

## **Guarantee:**

For guarantee purposes, please retain your purchase receipt



## All MuscleSquad Racks come with an Extended Guarantee for ultimate peace of mind.

**This includes:**

- 10 years frame cover
- 2 years parts cover

During this time if any repairs are needed please contact us directly so we can arrange a replacement.

**10 Year Frame  
Warranty**

**2 Year Parts  
Warranty**

**For ultimate  
peace of mind**

The guarantee is subject to the following provisions:

- The guarantee does not cover accidental damage, misuse, cabinet parts, knobs or consumable items.
- The product must be correctly installed and operated in accordance with the instructions contained in this manual.
- It must be used solely for domestic purpose.
- The guarantee will be rendered invalid if the product is re-sold or has been damaged by an inexpert repair or modification.
- Specifications are subject to change without notice.
- The manufacturer disclaims any liability for any incidental or consequential damages.
- The guarantee is in addition to and does not diminish your statutory or legal rights.