

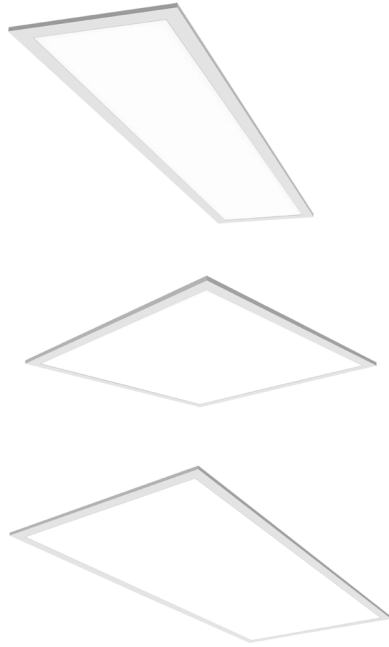

PROJECT NAME: _____ CAT. #: _____
 NOTES: _____ FIXTURE SCHEDULE: _____

MLFP Flat Panel Gen 4 Series Wattage and Color Selectable



Product Description:

A seamless replacement for 1'x4', 2'x2' and 2'x4' fluorescent fixtures, MaxLite's next-generation LED Flat Panels are designed to lay in drop ceilings in offices, schools, and healthcare applications. The panels produce highly efficient, uniform illumination, and offer the versatility of field-selectable color temperatures and wattages to suit various application needs. The panels are fully dimmable, and may be combined with motion sensors for further energy savings. MaxLite panels deliver all the benefits of LED technology, including a long life with high lumen maintenance, reduced energy consumption and lower maintenance costs.

Features:

- Field Wattage and CCT Selectable
- Fixtures are set to lowest wattage and 4000K as default factory setting
- Fixed Wattage units also available
- 0-10V Dimmable
- Voltage: 120-277V
- L70 Lumen Maintenance ≥100,000 at 40°C (104°F)
- On EM mode, the fixture output a minimum of 700 lumens for 90 minutes, when fully charged

Order Structure

FAMILY	SIZE	PANEL TYPE	WATTAGE SELECTABLE	CCT SELECTABLE	BATTERY BACKUP	SENSOR
MLFP= Flat Panel	14= 1'x4'	G4= Backlit	20W= 20W, 25W, 30W	CS= CCT Selectable 3500K, 4000K, 5000K	[BLANK]= None EM= Battery Backup	[BLANK]= None MS= Bi-level Microwave Motion Sensor (Low-Voltage)
	22= 2'x2'		18W= 18W, 27W, 36W			
	24= 2'x4'		27W= 27W, 36W, 45W			
	SIZE		WATTAGE	CCT	BATTERY BACKUP	SENSOR
	22'= 2'x2'		30'= 30W	40= 4000K	[BLANK]= None EM= Battery Backup	[BLANK]= None MS= Bi-level Microwave Motion Sensor (Line Voltage)
	24'= 2'x4'		40'= 40W			
	SIZE		WATTAGE	CCT SELECTABLE	BATTERY BACKUP	SENSOR
	22= 2'x2'		18= 18W	CS= CCT Selectable 3500K, 4000K, 5000K	[BLANK]= None EM= Battery Backup	[BLANK]= None MS= Bi-level Microwave Motion Sensor (Low-Voltage)
24= 2'x4'	28= 28W					

NOTES:
 1 On EM mode, the fixture CCT will be set to 5000K

Stocked Items

ORDER CODE	MODEL NUMBER	DLC PRODUCT ID #	DIMENSION (L" X W" X H")Y	ORDER CODE	MODEL NUMBER	DLC PRODUCT ID #	DIMENSION (L" X W" X H")Y
104372	MLFP14G420WCS	PKL0UT6P	47.7" x 11.9" x 2.2"	105345	MLFP22G418CS	PMQN4X76	23.7" x 23.7" x 2.2"
104373	MLFP22G418WCS	PX9RHOZS	23.7" x 23.7" x 2.2"	105346	MLFP24G428CS	P5IRS6Z	47.7" x 23.7" x 2.3"
104374	MLFP24G427WCS	PSR53N2J	47.7" x 23.7" x 2.3"				
104497	MLFP22G43040	PL308UXST9YM	23.7" x 23.7" x 2.2"				
104498	MLFP24G44040	PLG7OHLXAWI5	47.7" x 23.7" x 2.3"				









10-year standard warranty with labor allowance* (further details available at www.maxlite.com/warranties)

*Warranty Limitations: Product must be rated for the application per the Product Data Sheet (PDS); operated ≤16 hrs/day; in ambient of -4°F to 77°F. *Up to \$25/unit; labor allowances of up to \$500/unit available for purchase – contact MaxLite representative for details.

MLFP Flat Panel Gen 4 Series

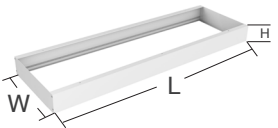
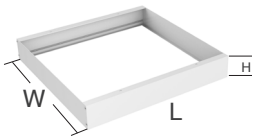
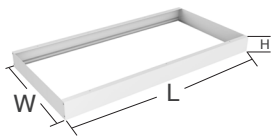
Wattage and Color Selectable



Accessories (SOLD SEPARATELY)

ORDER CODE	MODEL NUMBER	DESCRIPTION	IMAGE
104817	ML14G4FK	Gen 4 1x4' Flat Panel Flange Kit	
104819	ML22G4FK	Gen 4 2x2' Flat Panel Flange Kit	
104820	ML24G4FK	Gen 4 2x4' Flat Panel Flange Kit	
104811	ML14G4SMK	Gen 4 1X4 Flat Panel Surface Mount Kit (47.87" L X 12.32" W X, 3.7" H)	
104813	ML22G4SMK	Gen 4 2X2 Flat Panel Surface Mount Kit (23.85" L X 24.97" W X 3.7" H)	
104814	ML24G4SMK	Gen 4 2X4 Flat Panel Surface Mount Kit (47.87" L X 24.97" W X 3.7" H)	
104816	MLG4CHK	Gen 4 Cable Hanging Kit For 1x4 & 2x2 Flat Panel	
104848	ML24G4CHK	Gen 4 Cable Hanging Kit For 2x4 Flat Panel - 6 Cables	
104799	RMRC-100 ¹	Remote control for MS option of WCS and CS models	
104891	RMHD05R ²	Remote control for MS option of Fixed wattage 4000K models.	

¹ RMRC-100 remote applies to the Microwave Motion Sensor option for WCS and CS models.

² RMHD05R remote applies to the Microwave Motion Sensor option for fixed wattage 4000K models.

Sensor

SENSOR	TECHNOLOGY	DIMMING	DAYLIGHT HARVESTING	REMOTE CONTROL	QR CODE
MS for WCS and CS models	Microwave motion sensing	Bi-Level	Photoelectric sensor Set point on/off	RMRC-100	
MS for Fixed wattage 4000K models	Microwave motion sensing	Bi-Level	Photoelectric sensor Set point on/off	RMHD05R	

¹ RMRC-100 remote applies to the Microwave Motion Sensor option for WCS and CS models.

MLFP Flat Panel Gen 4 Series

Wattage and Color Selectable

Specifications	MLFP14G4XXWCS		
Size	1'X4'		
Power Consumption	20W*	25W	30W
Lumens Delivered	2540, 2600*, 2590 lm	3020, 3130, 3080 lm	3600, 3790, 3700 lm
Efficacy	126, 133*, 126 lm/w	121, 130, 122 lm/w	118, 128, 119 lm/w
CRI	≥80		
Color Temperature (K)	3500K, 4000K*, 5000K	3500K, 4000K, 5000K	3500K, 4000K, 5000K
L70 Lumen maintenance	≥100,000 Hrs		
Power Factor	>0.9		
Input Voltage	120-277V		
Comp Dimmer	Designed to be compatible with most 0-10V dimmers		
Mounting	Surface mount, Flange mount and Aircraft cables		
Operating Temperature	-4°F to 122°F (-20°C to 50°C)		
Humidity	20% to 85% RH non-condensing		
Certification	ETL Listed, FCC		
Material Usage	RoHS Compliant; No Mercury		
Environment	Damp/ Dry Location		
DesignLight Consortium	DLC Standard		
Warranty	10 Years warranty		

* Factory default for all Wattage select is the lowest wattage and CCT select is 4000K

NOTE:

1. Other wattages and CCTs are adjusted in the field by installer.

Specifications	MLFP22G4XXWCS			MLFP22G43040	MLFP22G418CS
Size	2'X2'				
Power Consumption	18W*	27W	36W	30W	18W
Lumens Delivered	2000, 2040*, 2080 lm	2900, 3040, 3030 lm	3820, 4000, 4000 lm	3390 lm	2000 lm
Efficacy	113, 119*, 117 lm/w	110, 119, 113 lm/w	107, 118, 112 lm/w	113 lm/W	110 lm/w
CRI	≥80				
Color Temperature (K)	3500K, 4000K*, 5000K	3500K, 4000K, 5000K	3500K, 4000K, 5000K	4000K	3500K, 4000K, 5000K
L70 Lumen maintenance	≥100,000 Hrs				
Power Factor	>0.9				
Input Voltage	120-277V				
Comp Dimmer	Designed to be compatible with most 0-10V dimmers				
Mounting	Surface mount, Flange mount and Aircraft cables (Information needs to be confirmed)				
Operating Temperature	-4°F to 122°F (-20°C to 50°C)				
Humidity	20% to 85% RH non-condensing				
Certification	ETL Listed, FCC			cULus Listed, FCC	ETL Listed, FCC
Material Usage	RoHS Compliant; No Mercury				
Environment	Damp/ Dry Location				
DesignLight Consortium	DLC Standard				
Warranty	10 Years warranty				

* Factory default for all Wattage select is the lowest wattage and CCT select is 4000K

NOTE:



MLFP Flat Panel Gen 4 Series

Wattage and Color Selectable

Specifications

Specifications	MLFP24G4XXWCS			MLFP24G44040	MLFP24G428CS
Size	2'X4'				
Power Consumption	27W*	36W	45W	40W	28W
Lumens Delivered	3140, 3260*, 3220 lm	4090, 4030, 4170 lm	4920, 5200, 5040 lm	4760 lm	3100 lm
Efficacy	118, 126*, 121 lm/w	114, 124, 115 lm/w	111, 121, 111 lm/w	114 lm/W	110 lm/w
CRI	≥80				
Color Temperature (K)	3500K, 4000K*, 5000K	3500K, 4000K, 5000K	3500K, 4000K, 5000K	4000K	3500K, 4000K, 5000K
L70 Lumen maintenance	≥100,000 Hrs				
Power Factor	>0.9				
Input Voltage	120-277V				
Comp Dimmer	Designed to be compatible with most 0-10V dimmers				
Mounting	Surface mount, Flange mount and Aircraft cables (Information needs to be confirmed)				
Operating Temperature	-4°F to 122°F (-20°C to 50°C)				
Humidity	20% to 85% RH non-condensing				
Certification	ETL Listed, FCC			cULus Listed, FCC	ETL Listed, FCC
Material Usage	RoHS Compliant; No Mercury				
Environment	Damp/ Dry Location				
DesignLight Consortium	DLC Standard				
Warranty	10 Years warranty				

* Factory default for all Wattage select is the lowest wattage and CCT select is 4000K

NOTE:

1. Other wattages and CCTs are adjusted in the field by installer.

MLFP Flat Panel Gen 4 Series Wattage and Color Selectable

DIMENSIONS

MLFPxxG4yyWCS MODELS (COLOR AND WATTAGE SELECT MODELS) & MLFPXXG4YYWCS (FIXED WATTAGE CCT SELECT MODELS)

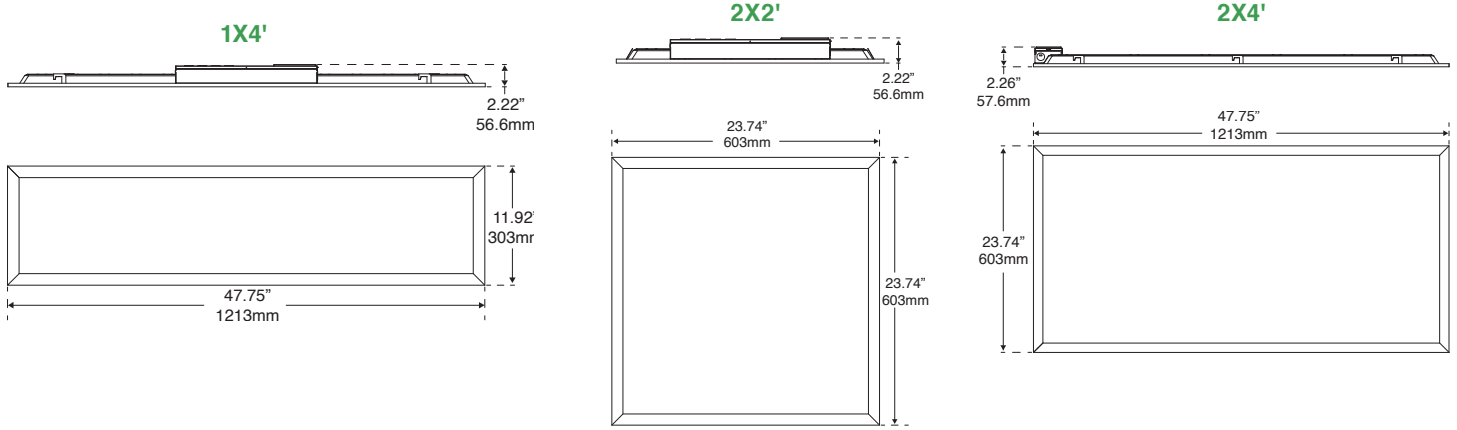

DIMENSIONS

MLFP22G43040 & MLFP24G44040

These models come with optional J-Box in every fixture for ease of wiring.

30W - 2X2'

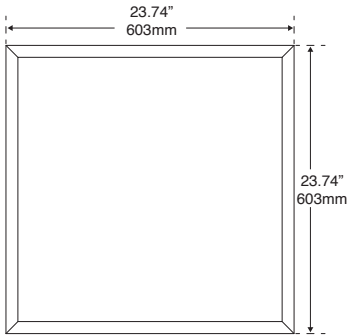

40W - 2X4'

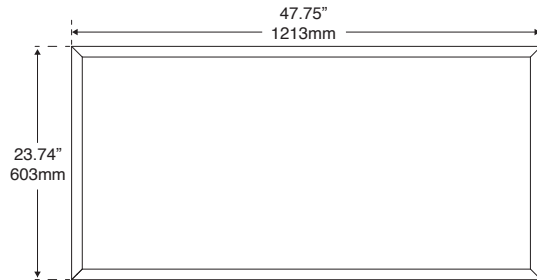

WITH J-BOX

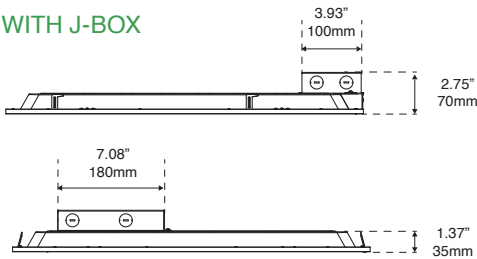

WITH J-BOX

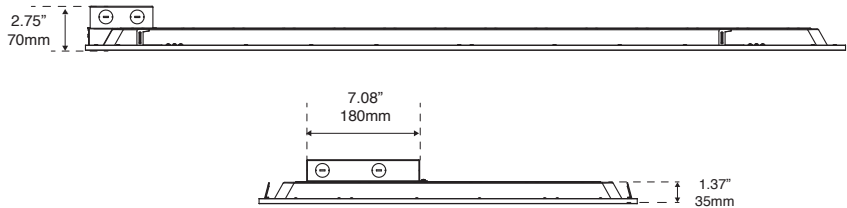

WITHOUT J-BOX

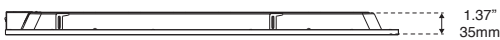

WITHOUT J-BOX

