

**LINEAR CLASS I DIVISION 1 EMERGENCY | HL-LI SERIES**

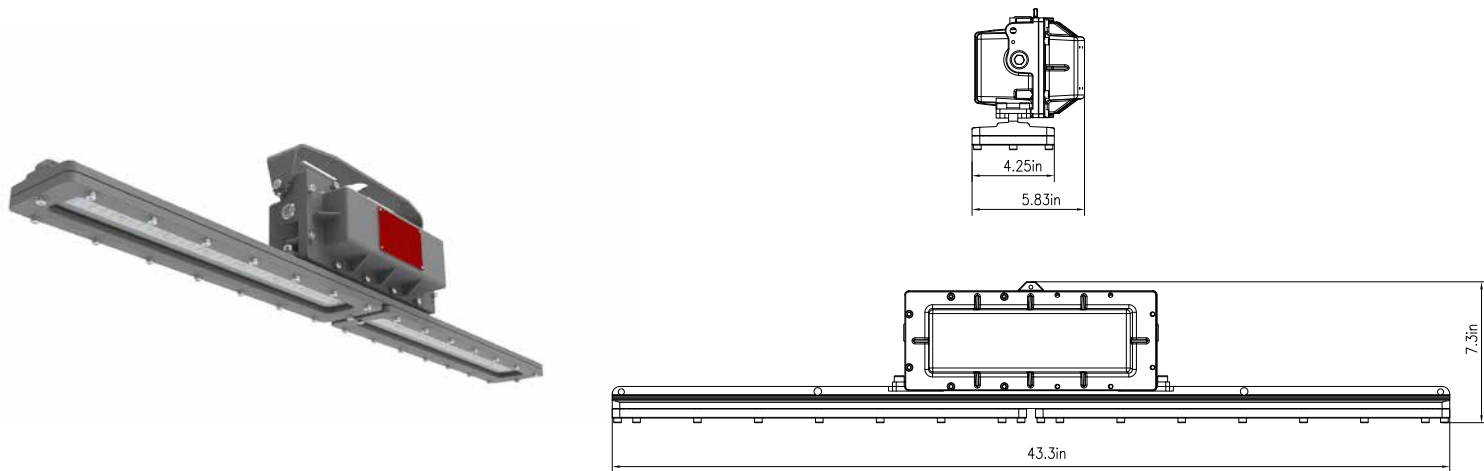

The **HL-LI SERIES** is a linear LED luminaire engineered to stand up to the toughest operating conditions in **Class I Division 1** environments made hazardous by the presence of flammable vapors or gases or combustible dusts. A slim and lightweight profile and variety of mounting options enable this long-lasting, high-performance fixture to address virtually any lighting need.



**CLASSIFICATIONS & RATINGS:**

- UL 844
- UL924
- Class I, Division 1, Groups C, D

**CONSTRUCTION:**

- Copper Free aluminum housing
- Stainless steel hardware
- Thermal shock and impact resistant PMMA tempered glass lens

**FEATURES:**

- Slim and compact design
- Power Factor: > 0.95
- Second retention point integral to fixture

**MOUNTING:**

- Ceiling/Wall Mount
- Pendant Mount
- Stanchion Mount
- Hanging Chain Mount

**APPLICATION:**



- Mining Sites/Heavy Industries
- Storage Facility/Paper Mills
- Wastewater Treatment Plants
- Chemical Processing Facility
- Petrochemical PProcessing Facility

MODEL SELECTION								
HL-	LI	48	80	U				P-D1EM2
FAMILY	SUB FAMILY	LENGTH	NOMINAL WATTAGE	VOLTAGE	DISTRIBUTION	LENS	CCT	CLASSIFICATION
HL-= Hazardous Location	LI= Linear, Gray finish	48= 48"	80= 80W	U= 120-277V	[BLANK]= Wide, 110° N= Narrow T= Type II	[BLANK]= Clear D1= Diffused	[BLANK]= 5000K	P-D1EM2= Battery Backup, -20 degree C

**Notes:**

1. Only available as wide distribution

# LINEAR CLASS I DIVISION 1 EMERGENCY | HL-LI SERIES

ACCESSORY			
ORDER CODE	ITEM #	DESCRIPTION	IMAGE
14100360	HLLIRB	Linear C1D1, Trunnion bracket, Ceiling/Wall Mount	
102934	HLSC250	Rig-a-lite 10128R lighting fixture safety cable, 4' long, 250 lbs rating	
106063	HLLISC	Safety cable , HL-LI series, stainless steel, 3 ft long	

**SPECIFICATIONS:**

ITEM	SPECIFICATION	HL-LI4880UP-D1EM2	HL-LI4880UDP-D1EM2	HL-LI4880UTP-D1EM2	HL-LI4880UNP-D1EM2	EMERGENCY MODE
		DETAILS				
GENERAL PERFORMANCE	Input Power (W)	80W				6W
	Lumens Delivered (lm)	9,000	8,000	9,500	9,500	750
	Efficacy (lm/W)	112.5	100	119	119	125
	CRI	> 70				
	Lumen Maintenance (L70, TM-21 @ 25°C)	>50,000				
	Color Temperature	5000K				
	Spacing Criteria	Available upon request				
ELECTRICAL	Power Factor	>0.95				
	Input Voltage	120-277V				
	Weight	12.2kg/26.9 lbs				
	Dimensions	47.2" x 4.3" x 7.3"				
	Humidity	5% - 95% RH, non-condensing				
	Operating Temperature	-20°C to + 45°C (-4°F to + 113°F)				
	Temperature Rating	T6				
CERTIFICATION	Certification	UL844, UL 8750, UL924, FCC				
	Environment	IP66				
	Material Usage	RoHS compliant; no mercury				
	Warranty	5 years				

**MOUNTING OPTIONS:**

Comes standard as a Pendant mount. Yoke bracket available as an optional accessory. Hardware required to alter the standard mounting option into other variations is not provided by Maxlite

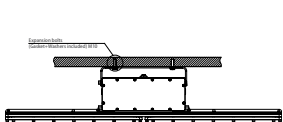

Ceiling Mount

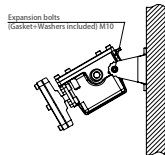

Wall Mount

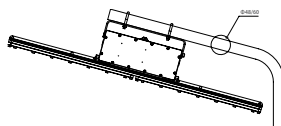

Stanchion Mount



Hanging Ring Mount

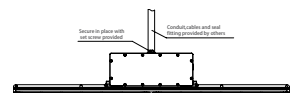

Pendant Mount